



**INTERNATIONAL
FEDERATION**
OF AMERICAN FOOTBALL

FOOTBALL RULES AND INTERPRETATIONS

2026 EDITION

Original material © IFAF 2011-2026
ISBN: 978-1-291-90105-4

Foreword

The rules are revised each year by IFAF to improve the sport's level of safety and quality of play, and to clarify the meaning and intent of rules where needed. The principles that govern all rule changes are that they must:

- be safe for the participants;
- be applicable at all levels of the sport;
- be coachable;
- be administrable by the officials;
- maintain a balance between offense and defense;
- be interesting to spectators;
- not have a prohibitive economic impact; and
- retain some affinity with the rules adopted by NCAA in the USA.

IFAF statutes require all member federations to play by IFAF rules, except in the following regards:

1. national federations may adapt Rule 1 to meet local needs and circumstances, provided no adaption reduces the safety of the players or other participants;
2. competitions may adjust the rules according to (a) the age group of the participants and (b) the gender of the participants;
3. competition authorities have the right to amend certain specific rules (listed on page 11);
4. national federations may restrict the above so that the same regulations apply to all competitions under their jurisdiction.

These rules apply to all IFAF organised competitions and take effect from 1st March 2026. National federations may adopt them earlier for their domestic competitions.

Prof Jim Briggs, Editor
on behalf of the IFAF Rules Committee
Andy Fuller, Managing Director
Pierre Trochet, President
Javier L'Episcopo, Director

Those who find it necessary to write to the editor for interpretations of rules or play situations will receive prompt replies if they number their questions and send them to jim.briggs@americanfootball.sport by email.

The editor would like to thank the following people who assisted in the production of this edition of the rulebook:

Amir Brooks (Great Britain), Phil Clarke (Great Britain), Eva Cloots (Belgium), John Cooper (Great Britain), Erik De Boeck (Belgium), Frank Eissa Barroso (Great Britain), Will Fazackerley (Great Britain), Dan Harries Davies (Great Britain), Perttu Hautala (Finland), Jonathan Husband (Great Britain), Radek Janhuba (Finland), Mark Looi (Australia), Ali May (Great Britain), Gerry Mellough (Great Britain), Richard Moger (Great Britain), Dave Moore (Great Britain), Cedric Palmans (Belgium), Euan Paterson (Great Britain), Elisey Rodriguez (Portugal), Asbjorn Rohold (Denmark), Hubert Romanczyk (Poland), Mark Schofield (Great Britain), Paul Sutton (Great Britain), Begum Kubra Tokyay (Turkiye), Stephan Tuinenburg (Czechia), Liam Wooton (Great Britain),

Cover image by Martin Pech, MartasRaw_

Table of Contents

Rules changes.....	4
Points of emphasis	6
The Football Code.....	9
Rules and Interpretations	11
Rule 1 — The Game, Field, Players and Equipment.....	13
Rule 2 — Definitions	29
Rule 3 — Periods, Time Factors and Substitutions	48
Rule 4 — Ball in Play, Dead Ball, Out of Bounds.....	72
Rule 5 — Series of Downs, Line to Gain	78
Rule 6 — Kicks.....	82
Rule 7 — Snapping and Passing the Ball	96
Rule 8 — Scoring.....	112
Rule 9 — Conduct of Players and Others Subject to the Rules.....	121
Rule 10 — Penalty Enforcement	143
Rule 11 — The Officials: Jurisdiction and Duties	151
Rule 12 — Instant replay	152
Summary of penalties	157
Officials' Signals.....	166
Appendix A — Guidelines for Game Officials for Serious On-Field Player Injuries.....	169
Appendix B — Guidelines for Game Officials and Game Management To Use Regarding Lightning.....	170
Appendix C — Concussions.....	172
Appendix D — Field Diagrams	174
Appendix E — Equipment: Additional Details	182
Rules application.....	188
Index of Rules and Interpretations	214

Rules changes

Major changes

The list below shows rule number, description of the change, and page number in this book.

Major changes are marked by a box like this. [New or modified text is marked in blue \(grey when printed in monochrome\).](#)

2-8-3-b	T signal defined as an invalid fair catch signal	33
2-16-10-a	Scrimmage kick formation redefined	37
3-1-3-h	Extra period timeouts modified	49
3-3-6-a-1	Adjustment to the injury timeout for feigning injuries	60
3-5-3 Penalty	Defensive substitution penalty after 2-minute warning	69
6-3-14-a	Adjustment for defensive linemen on scrimmage kick plays	91
7-1-5-a-4	Further defined defensive team pre-snap movements	100
7-1-5-a-5	Identifies protected starting signals for defense and offense	100
9-1-9-a	Roughing the passer extended to players in passing posture	126
9-1-14	Modifies snapper protection on scrimmage kick plays	128
10-2-2-b	Unsportsmanlike conduct behind neutral zone enforced from previous spot	145

New/Revised Approved Rulings

A.R. 3-2-4:VI	A.R. 3-3-4:III	A.R. 3-3-4:IV	A.R. 3-3-6:X	A.R. 3-3-6:XI
A.R. 3-3-6:XII	A.R. 3-3-6:XIII	A.R. 3-3-6:XIV	A.R. 3-3-6:XV	A.R. 3-3-6:XVI
A.R. 3-5-3:VIII	A.R. 3-5-3:IX	A.R. 3-5-3:X	A.R. 6-5-3:VII	A.R. 9-1-15:II

Editorial changes

The following list shows those rules that have been subject to editorial change, i.e. deletions, corrected errors, clarifications due to interpretation and items rewritten for readability. The list also includes those Approved Rulings altered to conform with rule changes. [New or modified text is marked in blue \(grey when printed in monochrome\).](#) A × symbol denotes where text has been deleted.

1-2-3-d	1-2-3-e	1-2-3-f
1-2-3-g	1-2-4-f	1-4-12
1-4-14-a-2	2-7-1	A.R. 2-8-3:II
2-25-11-c	2-27-14-k	3-2-2-g
3-2-4-c	3-2-4-c-5	3-3-6-b
3-3-6-e	3-3-6-f	A.R. 3-3-6:XVII
3-3-10-a	3-3-10-b-1	3-3-10-b-2
A.R. 3-5-2:V	4-1-2-b-2 Exception 3	4-1-2-c
4-1-2-d	4-1-3-b	7-1-6
A.R. 7-3-11:I	9-1-18	9-2-1-a-1-c
A.R. 9-2-3:I	9-2-5-b	A.R. 9-2-5:I
A.R. 9-2-5:II	A.R. 9-2-5:III	A.R. 9-3-3:I
A.R. 10-2-5:XI	11-2-2-c	12-1-2-a-12
12-1-5-a	12-2-3-a	12-2-3-b
Appendix C		

A "Field dimensions metric converter" has been added to Appendix D.

A new section "Rules application" has been added.

Summary of differences between NCAA and IFAF rules

NCAA Rule	IFAF difference
1-2-5-f	Procedure for dealing with missing goals.
1-4-8-d	Timeout if player does not respond to equipment enforcement.
1-4-11	Drones prohibited.
2-3-6-a	The free-blocking zone is centred on the snapper, not the middle lineman.
2-11-3	Definition of batting includes the head.
2-16-10-a	Punter needs only be 7 yards deep; kicker/holder need only be 5 yards deep to count as a scrimmage kick formation.
2-27-12	Whether a disqualified player is suspended for the next game is matter for the disciplinary authority. There is no distinction between disqualified and ejected - all such players must leave the playing enclosure.
3-1-1	During coin toss, teams must remain in the team area.
3-2-3	Period can be extended for foul on field goal or illegal touching violation.
3-2-4	Play clock reset only if it drops below 20 seconds before ball ready.
3-3-2	Running clock.
3-3-2-e-1	Clock stops to award all first downs, not just in last two minutes of half.
3-3-5	Two-minute warning lasts only as long as it takes to notify teams. Not a full timeout.
3-3-8	No short timeouts.
4-1-2-b	Ball may belong to recovering team after inadvertent whistle. Ball may belong to Team B after inadvertent whistle on scrimmage kick. Ignore inadvertent whistle if ball would have become dead anyway in the immediate continuing action.
4-1-3	Ball is dead if players in vicinity believe it is.
7-2-5	Both fumbles <i>and backward passes</i> out of bounds or at rest awarded according to forward fumble principles. NCAA rule does not apply to backward passes that go forward out of bounds.
9-1-3&4/9-5-1	No half-game suspensions.
9-1-7-c	Spot of foul for blocking out of bounds is spot on nearest sideline.
9-2-2	Additional unfair tactics.
9-2-2-e	No disqualification for illegal cleats.
9-2-2-f	No more than ONE player allowed to be assigned the same number in a competitive game.
9-2-7	Referee may require persons to be removed from the playing enclosure.
9-6	Flagrant unsportsmanlike conduct fouls can be reviewed for additional sanctions.
10-2-7-a	Non-flagrant personal foul enforcement can carry forward.
12	Instant replay rule provides more responsibility to the video judge, including calling major fouls and any fouls after the two-minute warning in the 4th quarter.

This list ignores differences that address field limitations, NCAA competition structures (e.g. conferences) or equipment restrictions. It also ignores minor wording changes that do not have significant effect on the way the game is played.

Points of emphasis

For 2026, the Rules Committee wishes coaches, players and officials to take particular note of the following points.

Sideline control

Coaches that need to have conversations with officials about specific rulings within the game must do so from the Team Area. Coaches are encouraged not to enter the field of play or leave the Team Area to debate officiating decisions, and those that do so will have committed an automatic Unsportsmanlike Conduct Foul.

Coaches will be allowed to only step to the sideline to call offensive and defensive signals after all action has ceased. That working space (six-foot white border) is intended to allow officials to adequately perform their duties; to protect the safety of officials, players and coaches; and to allow teams to demonstrate good sportsmanship within the team area. New for 2025, if any player, coach, or team personnel approaches an official with a device to review or view video during the game, that will result in an automatic unsportsmanlike conduct foul (Rule 9-2-1-a-1-m). Special attention should be given to the rule stating that if a coach receives two unsportsmanlike fouls in a single game, they are disqualified.

The Rules Committee has instructed officials to be more diligent in their observations of these actions and they are instructed to flag violations of the rule when it occurs in an area they can observe. Coaches are expected to set an appropriate, professional example for their players, fans and the many others who watch the game and to intervene when they see members of their team exhibit behavior that is not acceptable under the Sportsmanship guidelines of the Football Code.

Protection of defenseless players / targeting

The Rules Committee continues to embrace the targeting rule in order to promote player safety, reduce head contact and eliminate specific targeting actions from the game. The language in 9-1-3 and 9-1-4 stipulates that no player shall target and make forcible contact to the head or neck area of a defenseless player or contact an opponent with the crown (top) of their helmet. The definition of "crown of the helmet", [approved starting with the 2023 season](#), focused the attention on the top of the helmet. The term "forcible contact" has replaced the word "initiate" to ensure the intent of the rule is clear.

These actions are now in two rules: Targeting and Making Forcible Contact With the Crown of the Helmet (Rule 9-1-3) and Targeting and Making Forcible Contact to Head or Neck Area of a Defenseless Player (Rule 9-1-4). Use of the helmet as a weapon and intentional (targeted) contact to the head or neck area are serious safety concerns. The penalties for fouls under both 9-1-3 and 9-1-4 include automatic disqualification. We continue to emphasise that coaches and officials must be diligent to ensure that players understand and abide by these rules. Rule 2-27-14 defines and lists characteristics of a defenseless player.

Illegal contact against a quarterback/passer

Because of their position, the passer is often in a vulnerable position, with little or no opportunity to protect themselves from, or to prepare for, forcible contact. In recognition of this, there is an explicit rule (Rule 9-1-9) which addresses this unique situation: "No defensive player shall unnecessarily rough a passer when it is obvious the ball has been thrown."

The rule then lists several specific acts which are illegal when they occur against a passer or potential passer. The Rules Committee over time has given options for the quarterback to protect themselves, such as sliding feet first and to legally throw the ball away outside the tackle box. The definition of a defenseless player has been expanded to include an offensive player in a passing posture with focus

downfield, [even if a pass is not thrown](#). Because of the extremely vulnerable situation the quarterback position presents, it is important for all officials, and the referee and the centre judge in particular, to be a presence and recognise when a passer is threatened or is in a defenseless position. The crew must make it a priority to afford the quarterback all the protection the rules provide.

Feigning an injury

With the advent of the up-tempo offenses, there is a growing trend of defensive players feigning an injury in an attempt to slow down or break the rhythm of the offense and try to gain an unwarranted timeout. Full protection under the rules should go to a player that indeed suffers an injury; however, on occasion some potential injuries are suspect, happen in unusual windows between plays and appear to be staged. The Rules Committee had serious discussions on potential options on how to best take away incentive for players to feign an injury including adding additional time before a player could return from injury.

Head coaches are expected to set a culture within their team to ensure that this type of dishonest action will not be tolerated. Feigning an injury is not ethical and is completely against the spirit of fair competition. It is a bad look for our great game. [For the 2026 season, a new rule was approved to address these tactics. If a player presents as injured after the ball is spotted by the officials, that team will be charged a team timeout or a delay of game penalty if all timeouts have been used.](#)

Special attention is directed to the strongly-worded statement in The Football Code (Coaching ethics, paragraph g).

Concussions

Coaches and medical personnel should exercise caution in the treatment of a participant who exhibits signs of a concussion. When in question, officials will declare an injury timeout for any player exhibiting signs of a concussion. See Appendix C for detailed information.

Pre-snap actions for offense and defense / disconcerting signals / offensive alignment

The intent of pre-snap rules is to define and govern what is allowed by the offense and defense. The offense, by design, has an advantage of knowing the starting signal, cadence, or sound, and the defense has an advantage as they are not limited in terms of overall player movements before the snap. To discourage tactics at the line of scrimmage designed to cause an opponent to foul or to give either team an unmerited advantage, officials must be on high alert for any type of illegal pre-snap actions by either team. Additionally, coaches should not teach illegal pre-snap actions designed to make their opponent foul.

[Updated](#) language in Rule 7 makes it clear for Team A, that any movement that simulates action at the snap is a foul. This includes abruptly shifting a player or players that simulates the start of a play. Team B will be held to the same standard of not simulating action at the snap as Team A. Coordinated Team B movement, including lateral and backward movement that simulates action at the snap is a foul. Additionally, the defense cannot use words or signals that simulate the sound or cadence of, or otherwise interfere with the offensive starting signals. This includes using a clap on the defensive side of the ball that may disconcert the offense. [The terms "move" and "stem" are reserved for the defensive cadence and may not be used by the offense.](#) Also, for the current season, special focus on the offensive alignment is a point of emphasis. Guidelines have been introduced to ensure we are consistent in dealing with restricted linemen that are not on their line of scrimmage. Also, we will ensure that Team A is in proper alignment at the snap, especially when there is a player with an eligible number covered up. These type formations will be evaluated just as we do for "gadget plays" and the offense must be precise in their alignment or should be penalised.

Unsportsmanlike conduct / taunting

Currently the Rules Committee is satisfied with the solid judgement that officials are demonstrating evaluating celebration issues and this focus will continue. For the current season, it will be a point of emphasis for officials to penalise any taunting action that is directed at an opponent. These actions are a bad look for the game and can lead to unnecessary confrontations between the teams and must be eliminated. Further, any actions simulating gun violence, including brandishing a weapon, is unsportsmanlike conduct and will be penalised.

The pregame warm-up rules are designed to ensure proper sportsmanship before our contests. Officials should be vigilant during the pregame whenever players are on the field. Unsportsmanlike acts before the game are detrimental to the sport and should be monitored and violation penalised by the game officials. Postgame acts are the jurisdiction of the disciplinary authority. Coaches and players should be mindful of their actions and cannot allow poor sportsmanship to blemish positive work from the game. Disciplinary regulations will determine any postgame impacts to the participating players, coaches and institutions.

Pace of play, substitutions and length of game

Since the implementation of the 40-second play clock, we have seen an ever-increasing use of the up-tempo offense. This style of play is often used to prevent the defense from matching up to the current game situation by not being able to substitute, which may create an advantage for the offense.

The rules and properly executed officiating mechanics work well to prevent the offense from gaining an unintended advantage by allowing the defense to match up when the offense substitutes. The availability of a Centre Judge enhances the crew's ability to consistently administer the substitution process. Adherence to these guidelines will allow a reasonable amount of time for the defense to change personnel, if desired, following an offensive substitution.

Equally important are plays in which the offense does not substitute. In these situations, officials have been instructed that they are not to significantly increase the pace used to spot the ball and make it ready for play. Doing so would place the defensive team at a distinct disadvantage not intended by rule. It is important that a consistent pace be maintained when spotting the football and making it ready for play in all games. That will allow defensive coaches the ability to recognize how much time is available prior to the ball being ready for play and whether they will have an opportunity to make adjustments to personnel.

Proper implementation of these guidelines will ensure that the mechanics of game officials will not affect the balance between offense and defense and that neither team will gain an advantage not intended by rule regardless of the style of play.

Sportsmanship

After reviewing a number of plays involving unsportsmanlike conduct, the committee is firm in its support of the unsportsmanlike conduct rules as they currently are written and officiated. Many of these fouls deal with players who taunt their opponent or inappropriately draw attention to themselves in a premeditated, excessive or prolonged manner. Players should be taught the discipline that reinforces football as a team game.

The Rules Committee reminds head coaches of their responsibility for the behavior of their players before and after, as well as during, the game. Players must be cautioned against pre-game unsportsmanlike conduct on the field that can lead to confrontation between the teams. Such action can lead to penalties enforced on the opening kickoff, possibly including disqualification of players. Repeated occurrence of such unsportsmanlike behavior by a team may result in punitive action by the disciplinary authority against the head coach and their institution.

Coaches and players are reminded of their responsibility to show class and sportsmanship in all postgame activities. Postgame actions that are unsportsmanlike may also result in action by the disciplinary authority to the team or player.

The Football Code

Introduction

Football is an aggressive, rugged contact sport. Only the highest standards of sportsmanship and conduct are expected of players, coaches and others associated with the game. There is no place for unfair tactics, unsportsmanlike conduct or manoeuvres deliberately designed to inflict injury.

IFAF believes:

1. The Football Code shall be an integral part of this code of ethics and should be carefully read and observed.
2. To gain an advantage by circumvention or disregard for the rules brands a coach or player as unfit to be associated with football.

Through the years, the rules committee has endeavoured by rule and appropriate penalty to prohibit all forms of unnecessary roughness, unfair tactics and unsportsmanlike conduct. But rules alone cannot accomplish this end. Only the continued best efforts of coaches, players, officials and all friends of the game can preserve the high ethical standards that the public has a right to expect in the sport.

Therefore, as a guide to players, coaches, officials and others responsible for the welfare of the game, the committee publishes the following code:

Coaching ethics

Deliberately teaching players to violate the rules is indefensible. The coaching of intentional holding, beating the ball, illegal shifting, feigning injury, interference, illegal forward passing or intentional roughing will break down rather than aid in the building of the character of players. Such instruction is not only unfair to one's opponents but is demoralising to the players entrusted to a coach's care and has no place in the game.

The following are unethical practices:

1. Changing numbers during the game to deceive the opponent.
2. Using the football helmet as a weapon. The helmet is for the protection of the player.
3. Targeting and making forcible contact. Players, coaches and officials should emphasise the elimination of targeting and making forcible contact against a defenseless opponent and/or with the crown of the helmet.
4. Using non-therapeutic drugs in the game of football. This is not in keeping with the aims and purposes of amateur athletics and is prohibited.
5. "Beating the ball" by an unfair use of a starting signal. This is nothing less than deliberately stealing an advantage from the opponent. An honest starting signal is needed, but a signal that has for its purpose starting the team a fraction of a second before the ball is put in play, in the hope that it will not be detected by the officials, is illegal. It is the same as if a sprinter in a 100-metre dash had a secret arrangement with the starter to give them a tenth-of-a-second warning before firing the pistol.
6. Shifting in a way that simulates the start of a play or employing any other unfair tactic for the purpose of drawing one's opponent offside. This can be construed only as a deliberate attempt to gain an unmerited advantage.
7. Feigning an injury for any reason is unethical. An injured player must be given full protection under the rules, but feigning injury is dishonest, unsportsmanlike and contrary to the spirit of the rules. Such tactics cannot be tolerated among sportspersons of integrity.

IFAF also believes:

1. In their relationship with players under their care, the coach should always be aware of the tremendous influence they wield, for good or bad. The coach should never place the value of a

win above that of instilling the highest desirable ideals and character traits in their players. The safety and welfare of their players should always be uppermost in their mind, and they must never be sacrificed for any personal prestige or selfish glory.

2. In teaching the game of football, the coach must realise that certain rules exist that are designed to protect the player and provide common standards for determining a winner and a loser. Any attempt to beat these rules, to take unfair advantage of an opponent, or to teach deliberate unsportsmanlike conduct, have no place in the game of football, nor has any coach guilty of such teaching any right to call themselves a coach. The coach should set the example for winning without boasting and losing without bitterness. A coach who conducts themselves according to these principles need have no fear of failure, for in the final analysis, the success of a coach can be measured in terms of the respect they have earned from their players and from their opponents.
3. The diagnosis and treatment of injuries is a medical problem and should under no circumstances be considered a province of the coach.
4. Under no circumstances should a coach authorise the use of drugs. Medicines, stimulants, or drugs should be used only when authorised and supervised by a physician. Coaches should be aware that the willful oversight of drug abuse by players under their care may be construed as condoning such action. Coaches should be acquainted with, and remain aware of the current IFAF policy on drugs.

Talking to an opponent

Talking to an opponent in any manner that is demeaning, vulgar, abusive or "trashy" or intended to incite a physical response or verbally put an opponent down is illegal. Coaches are urged to discuss this conduct frequently and support all officials' actions to control it.

Talking to officials

When an official imposes a penalty or makes a decision, they are simply doing their duty as they see fit. They are on the field to uphold the integrity of the game of football, and their decisions are final and conclusive and should be accepted by players and coaches.

Our Code of Ethics states:

1. On- and off-the-record criticism of officials to players or to the public shall be considered unethical.
2. For a coach to address, or permit anyone on their bench to address, uncomplimentary remarks to any official during the progress of a game, or to indulge in conduct that might incite players or spectators against the officials, is a violation of the rules of the game and must likewise be considered conduct unworthy of a member of the coaching profession.

Holding

Illegal use of the hands or arms is unfair play, eliminates skill and does not belong in the game. The object of the game is to advance the ball by strategy, skill and speed without illegally holding your opponent. All coaches and players should thoroughly understand the rules for proper offensive and defensive use of the hands. Holding is a frequently called foul; it is important to emphasise the severity of the penalty.

Sportsmanship

The football player or coach who intentionally violates a rule is guilty of unfair play and unsportsmanlike conduct; and whether or not they escape being penalised they bring discredit to the good name of the game, which is their duty as a player or coach to uphold.

Rules and Interpretations

Rules

IFAF Football Rules and Interpretations have been designated as either administrative rules or conduct rules. Typically, administrative rules are those dealing with preparation for the contest. Conduct rules are those that have to do directly with the playing of the contest. Some administrative rules (as indicated) may be altered by the mutual consent of the competing teams. Others (as indicated) are unalterable. No conduct rule may be changed by mutual consent. All teams are required to conduct their competitive contests according to these rules.

Administrative rules that may be altered by mutual consent of the competing teams include (denoted \emptyset in the text):

1-2-5-f-3 1-2-5-f-4 1-4-5-b-2 1-4-12-a 3-2-1-b 3-2-2-a

Some rules may be altered by game management without mutual consent of the opponents. These are contained in Rules (denoted \square in the text):

1-2-1-f 1-2-1-g 1-2-1-h 1-2-1-i 1-2-1-j 1-2-1-k 1-2-4-f
1-2-5-c 1-2-7-c 1-2-7-d 1-2-7-f 3-2-4-a 3-2-4-b

Some rules may be altered by game management without consent, but only if it is not feasible to meet the rule. Teams are encouraged to meet the standards specified by rule wherever possible. These are contained in Rules (denoted \S in the text):

1-2-1-a 1-2-1-b 1-2-1-c 1-2-1-d 1-2-3-a 1-2-3-c 1-2-5-b
1-2-6 1-3-2-b 1-4-13-a 3-2-1-d 3-2-1-e

Some administrative rules allow competitions to stipulate in their regulations what course of action is to be followed. (A national federation may decide the policy for all competitions under its jurisdiction.) These are Rules (denoted ∇ in the text):

3-1-3 3-2-1 3-3-2 3-3-3-c 3-3-3-d

Other administrative rules may not be altered. The referee shall make a report to the appropriate authority if these rules are infringed (denoted # in the text):

1-1-1-a 1-1-2 1-1-3-a 1-1-3-b 1-1-4 1-1-5 1-1-6
1-1-7-b 1-1-7-c 1-2-1-a-1 1-2-1-a-2 1-2-1-e 1-2-1-l 1-2-1-m
1-2-1-n 1-2-1-o 1-2-2 1-2-3-b 1-2-3-d 1-2-3-e 1-2-3-f
1-2-3-g 1-2-4-a 1-2-4-b 1-2-4-c 1-2-4-d 1-2-4-e 1-2-5-a
1-2-5-c 1-2-5-d 1-2-5-e 1-2-5-f 1-2-7 1-2-7-a 1-2-7-b
1-2-7-e 1-2-8-a 1-2-8-b 1-2-8-c 1-2-8-d 1-2-8-e 1-2-9-a
1-2-9-b 1-3-1-a 1-3-1-b 1-3-1-c 1-3-1-d 1-3-1-e 1-3-1-f
1-3-1-g 1-3-1-h 1-3-1-i 1-3-2-c 1-3-2-d 1-3-2-e 1-3-2-e-1
1-3-2-e-2 1-4-5-b-1 1-4-5-b-3 1-4-9 1-4-9-a 1-4-9-b 1-4-9-c
1-4-9-d 1-4-11-a 1-4-11-a-1 1-4-11-a-2 1-4-11-a-3 1-4-11-b 1-4-11-c
1-4-11-d 1-4-11-e 1-4-11-f 1-4-12 3-2-1-f 3-2-1-g 11-1-1
11-2-1 11-2-2

All other rules are conduct rules and may not be altered.

Interpretation and application of the rules

A football rule interpretation, also known as an approved ruling (A.R.), is an official decision on a given statement of facts. It serves to illustrate the spirit and application of the rule.

Officiating responsibilities and mechanics are specified in the current edition of the *Manual of Football Officiating*, published by IAFOA [www.myiafoa.org]. [Its Chapter 3 has been updated and is reproduced here as *Rules Application* \(page 188\) to emphasise the standards for officiating](#), which should be considered as part of these rules.

The Football Code, which appears in these Football Rules and Interpretations, should be studied carefully so the accepted conduct and practices are understood by all persons associated with American football.

Prof Jim Briggs, Rules Editor

RULE 1

The Game, Field, Players and Equipment

National federations may adapt Rule 1 to meet local needs and circumstances, provided no adaption reduces the safety of the players or other participants.

SECTION 1. General Provisions

The Game

- ARTICLE 1. a. # The game shall be played between two teams of not more than 11 players each, on a rectangular field and with an inflated ball having the shape of a prolate spheroid.
- b. A team legally may play with fewer than 11 players, but a foul for an illegal formation occurs if the following requirements are not met:
1. When the ball is free-kicked, at least four Team A players are on each side of the kicker (Rule 6-1-2-c-3).
 2. At the snap, at least five players wearing jerseys numbered 50 through 79 are on the offensive scrimmage line and no more than four players are in the backfield (Rules 2-21-2, 2-27-4 and 7-1-4-a) (*Exception:* Rule 7-1-4-a-5). (**A.R. 7-1-4:IV-VI**)

Goal Lines

ARTICLE 2. # Goal lines, one for each team, shall be established at opposite ends of the field of play, and each team shall be allowed opportunities to advance the ball across the other team's goal line by running, passing or kicking it.

Winning Team and Final Score

- ARTICLE 3. a. # The teams shall be awarded points for scoring according to rule and, unless the game is forfeited, the team having the larger score at the end of the game shall be the winning team.
- b. # When the referee declares that the game is ended, the score is final.

Game Officials

ARTICLE 4. # The game shall be played under the supervision of the game officials as specified in Rule 11.

Team Captains

ARTICLE 5. # Each team shall designate to the referee not more than four players as its field captain(s). One player at a time shall speak for their team in all dealings with the officials.

Persons Subject to the Rules

- ARTICLE 6. # a. All persons subject to the rules are governed by the decisions of the officials.
- b. Those persons subject to the rules are: everyone in the team area, players, substitutes, replaced players, coaches, athletics trainers, cheerleaders, band members, mascots, public-address announcers, audio/video/lighting system operators, and other persons affiliated with the teams.

Entities Subject to the Rules

ARTICLE 7. a. These rules apply to all competitions sanctioned by IFAF and by IFAF member federations. Subject to the agreement of IFAF, the rules may be altered by a competition authority where appropriate and necessary to adjust for:

1. The age group of the participants.
 2. The gender of the participants.
- b. # IFAF-affiliated officiating organisations shall use the current Manual of Football Officiating published under the jurisdiction of IAFOA.
- c. # IFAF-affiliated teams and/or competitions and/or national federations not complying with IFAF football-playing rules are subject to sanctions.

SECTION 2. The Field

Dimensions and Markings

ARTICLE 1. The field shall be a rectangular area with dimensions, lines, zones, goals and pylons as indicated in Appendix D.

- a. § Where the size of the stadium does not permit a full-sized field to be marked, game management may use an *IFAF yard* as the unit of measurement.
1. # An IFAF yard is normally 36 inches (91.44cm) long, but may be shortened to no less than 34.12 inches (86.67cm) only if necessary to fit a 100-yard field of play plus two 10-yard end zones within the available playing surface.
 2. # If the length of the field is reduced by an IFAF yard factor, all other field dimensions and markings stated in these rules shall be reduced commensurately (**Exception:** The length of the short yard-line extensions and the width of lines). The length of the yardage chain (Rule 1-2-7) shall also be reduced to correspond to the markings on the field.
- b. § All field-dimension lines shown must be white and 4 inches in width. (**Exceptions:** Sidelines and end lines may exceed 4 inches in width, goal lines may be 4 or 8 inches in width, and Rule 1-2-1-h).
- c. § Twenty-four-inch short yard-line extensions, four inches inside the sidelines and at the hash marks, are mandatory and all yard lines shall be four inches from the sidelines (Rule 2-12-6).
- d. § A solid white area between the sideline and the coaching line is mandatory.
- e. # White field markings or contrasting decorative markings (e.g. team names) are permissible in the end zones but shall not be closer than four feet to any line.
- f. Contrasting colouring in the end zones may abut any line.
- g. Only these contrasting decorative markings are allowed: competition logo, and team name and logo. These are permissible within the sidelines and between the goal lines, under these conditions (See Appendix D):
1. The entirety of all yard lines, goal lines and sidelines must be clearly visible. No portion of any such line may be obscured by decorative markings.
 2. No such markings may touch or enclose the hash marks, short yard-line extensions or numbers.
 3. A single decorative marking, centred on the midfield line, and a maximum of four smaller flanking decorative markings are allowed.
- h. Goal lines may be of one contrasting colour from the white lines.
- i. Advertising is permissible on the field, providing it meets the requirements of Rules 1-2-1-e, 1-2-1-f and 1-2-1-g.
- j. White field yard-line numbers not larger than 6 feet in height and 4 feet in width, with the tops of the numbers nine yards from the sidelines, are recommended.

- k. White directional arrows next to the field numbers (except at midfield) indicating the direction toward the nearest goal line are recommended. The arrow is a triangle with an 18-inch base and two sides that are 36 inches each.
- l. # The two hash marks are 60 feet from the sidelines. Hash marks and short yard-line extensions shall measure 24 inches in length.
- m. # Nine-yard marks 12 inches in length, every 10 yards, shall be located nine yards from the sidelines. They are not required if the field is numbered according to Rule 1-2-1-j.
- n. # In an indoor stadium, the roof shall be no less than 90 feet above the field.
- o. # If played in a stadium with a retractable roof, game management shall decide 90 minutes before kickoff whether to play the game with the roof open or closed. The roof must be closed if (from 90 minutes before the game until the end of the game) precipitation or lightning is within the vicinity of the stadium, the temperature drops below 40°F (4°C), or wind gusts are greater than 40 miles per hour (64 km/h). Once the roof is closed, it is not allowed to be reopened during the game.

Marking Boundary Areas

ARTICLE 2. # Measurements shall be from the inside edges of the boundary markings. The entire width of each goal line is in the end zone.

Limit Lines

- ARTICLE 3. a. § Limit lines shall be marked with 12-inch lines and at 24-inch intervals 18 feet outside the sidelines and the end lines, except in stadiums where the total field surface does not permit. In these stadiums, the limit lines shall be as far back as possible and not be less than six feet from the sidelines and end lines. Limit lines shall be 4 inches in width and may be yellow.
- b. # No person outside the team area shall be inside the limit lines. Game management personnel have the responsibility and the authority to enforce this rule. (**Exception:** Hand-held cameras under the supervision of the television partners may briefly be between the limit lines and the sideline after the ball is dead and the game clock has been stopped. This exception does not allow cameras to be on the field of play or in the end zone at any time.)
 - c. § Limit lines shall also be marked six feet from the team area around the side and back of the team area, if the stadium permits.
 - d. # The *safety zone* is defined as the area within 18 feet of the playing surface (field of play plus end zones), excluding areas located behind a safety fence. This area applies even if the limit lines are marked closer to the playing surface.
 - e. # No spectator, photographer, videographer or other media person may be located within the safety zone at any time during the game. **Exceptions:**
 - 1. During the coin toss ceremony and the period between halves.
 - 2. Television camera operators when the ball is dead and the game clock has been stopped (Rule 1-2-3-b Exception).
 - 3. Team videographers (Rule 1-4-11-c Exception 5).
 - 4. Media personnel and other authorised personnel transiting purposefully through the safety zone when it is safe to do so.
 - f. # No object (e.g. furniture, equipment) may be placed on the ground within the safety zone at any time during the game except the period between halves (**Exceptions:** Rules 1-2-5, 1-2-6, 1-2-7, 1-2-8-e).
 - g. # Any person legally allowed to be within the safety zone (e.g. coaches, substitutes, team personnel, officials' assistants) must always remain upright and on their feet during play. Persons with mobility limitations are prohibited in this area. A mobility limitation is anything that would

prevent a person moving quickly out of the way should a participant approach them. (Persons sitting, crouching, kneeling or lying on the ground, or requiring walking aids, may be unable to get out of the way of rapidly approaching players.)

Team Area and Coaching Box

- ARTICLE 4. a. # On each side of the field, a team area behind a solid line 12 feet outside the sideline and between the 20-yard lines shall be marked for the exclusive use of substitutes, athletics trainers and other persons affiliated with the team. The front of the coaching box shall be marked with a solid line six feet outside the sideline between the 20-yard lines. The area between the coaching line and the 12-foot line between the 20-yard lines shall contain white diagonal lines or be marked distinctly for use of coaches (Rule 9-2-5). A 4-inch-by-4-inch mark is mandatory at each five-yard line extended between the goal lines as an extension of the coaching line for line-to-gain and down indicator six-foot reference points.
- b. # The team area shall be limited to squad members in full uniform and a maximum of 25 other individuals directly involved in the game. All persons in the team area are subject to the rules and are governed by decisions of the officials (Rule 1-1-6). The 25 individuals not in full uniform shall wear special team area credentials. No other credential is valid for the team area. Medical personnel are exempted from the 25-credential limit and should have a separate, distinct pass.
- c. # Coaches are permitted in the coaching box (see Appendix D), which is the area bounded by the 12-foot line and coaching line between the 20-yard lines.
- d. # No media personnel, including journalists, radio and television personnel, or their equipment, shall be in the team area or coaching box, and no media personnel shall communicate in any way with persons in the team area or coaching box. In stadiums where the team area extends to the spectator seating area, a pass-through area should be made available for media to move from one end of the field to the other on both sides of the field.
- e. # Game management personnel shall remove all persons not authorised by rule.
- f. Practice kicking nets are not permitted outside the team area (**Exception:** In stadiums where playing enclosures are limited in size, nets, holders and kickers are permitted outside the team area and outside the [safety zone](#)). (Rule 9-2-1-b-1).

Goals

- ARTICLE 5. a. # Each goal shall consist of two white or yellow uprights extending at least 30 feet above the ground with a connecting white or yellow horizontal crossbar, the top of which is 10 feet above the ground. The inside of the uprights and crossbar shall be in the same vertical plane as the inside edge of the end line. Each goal is out of bounds (see Appendix D). (**A.R. 1-2-5:I**)
- b. § Above the crossbar, the uprights shall be white or yellow and 18 feet, six inches apart inside to inside.
- c. # The designated uprights and crossbar shall be free of decorative material (**Exception:** 4-inch-by-42-inch orange or red wind directional streamers at the top of the uprights are permitted).
- d. # The height of the crossbar shall be measured from the top of each end of the crossbar to the ground directly below.
- e. # Goal posts shall be padded with resilient material from the ground to a height of at least six feet. (**Exception:** This is not a requirement if the goal post is more than 12 feet outside the end line, or there is a non-hazardous barrier between the end line and the goal post that would prevent players from running into the goal post.) Advertising is prohibited on the goals. One manufacturer's logo or trademark or an advertisement is permitted on each goal post pad. Team/national and competition logos are allowed. All padding is out of bounds.
- f. # The following procedure will be adopted when one or both goals are missing or have been taken down and the original goals are not available for a try or field goal attempt:

1. If a portable goal is available, it shall be erected or held in place at the request of Team A.
2. If a portable goal is not available but one goal is in place:
 - (a) On all scrimmage downs, Team B shall defend the end of the field where the goal is situated.
 - (b) On all free kick downs, Team A shall defend the end of the field where the goal is situated.
 - (c) After a change of possession, the teams will change ends if necessary so that Team B is defending the end where the goal is situated.
 - (d) There will be no change of ends at the end of the first or third periods (one minute timeout only). Captains will not have the option to select which goal line to defend at the beginning of a half or the start of an extra period.
3. Ø Alternatively, if one goal is (or becomes) missing or unusable, the game may proceed (or resume) without using the other goal, if both head coaches agree. In these circumstances no (further) field goals shall be scored. Once stated, the coaches' decisions as to whether to proceed without goals shall be irrevocable.
4. Ø If no goals are available, the game may be played if both head coaches agree. In these circumstances no field goals shall be scored. If one or both head coaches do not wish to play, then the game shall be abandoned. Once stated, the coaches' decisions as to whether to start/continue shall be irrevocable.

Approved Ruling 1-2-5

- i. Upon inspection of the field it is noted that goals with offset uprights are being used. The plane of the goal is one yard within the end zone and the post is one yard outside it. **RULING:** Legal. The goal post is not inbounds. [Cited by 1-2-5-a]

Pylons

ARTICLE 6. § Soft flexible four-sided pylons 4 inches by 4 inches with an overall height of 18 inches, which may include a two-inch space between the bottom of the pylon and the ground, are required. They shall be red or orange in colour. One manufacturer's logo or trademark is permitted on each pylon. Team/national logos, competition logos and the name/commercial logo of the title sponsor of the game are also allowed. Any such marking may not extend more than 3 inches on any side. They are placed at the inside corners of the eight intersections of the sidelines with the goal lines and end lines. The pylons marking the intersections of the end lines and hash marks extended shall be placed three feet off the end lines.

- a. A displaced pylon is one that is no longer in its proper position. Unless it is obvious that at least some part of the pylon is touching the ground in the 4-inch by 4-inch square that is its proper position, the pylon is no longer a pylon for the purposes of the rules (e.g. Rule 8-2-1-a). A displaced pylon may be restored to its proper position at any time.
- b. Touching a displaced pylon that is partially or completely out of bounds makes the ball or player out of bounds (Rule 4-2).
- c. A displaced pylon that is completely inbounds is no longer a pylon and is to be considered as part of the playing surface.
- d. A displaced goal line pylon that is partially in its proper position is still to be regarded as a goal line pylon for the purposes of the rules. Only parts of a displaced pylon that are behind the vertical plane of the goal line are behind the goal line.
- e. If a goal line pylon cannot be stood upright, it should be positioned so that it lies on the goal line extended out of bounds with its base covering the sideline.
- f. If an end line pylon cannot be stood upright, it should be positioned so that it lies on the sideline extended out of bounds with its base covering the end line.

Line-to-Gain and Down Indicators

ARTICLE 7. # The official line-to-gain (yardage chain) and down indicators shall be operated approximately six feet outside the sideline, except in stadiums where the total playing enclosure does not permit. These must be operated on the side of the field opposite the press box.

- a. # The yardage chain shall join two rods not less than five feet high, the rods' inside edges being exactly 10 yards apart when the chain is fully extended. The chain shall be made from material that does not stretch or break in normal use.
- b. # The down indicator shall be mounted on a rod not less than five feet high operating approximately six feet outside the sideline opposite the press box.
- c. An unofficial auxiliary line-to-gain indicator and an unofficial down indicator six feet outside the other sideline are recommended.
- d. Unofficial red or orange non-slip line-to-gain ground markers positioned off the sidelines on both sides of the field are recommended. Markers are rectangular, weighted material 10 inches by 32 inches. A triangle with an altitude of five inches is attached to the rectangle at the end toward the sideline.
- e. # All line-to-gain and down-indicator rods shall have flat ends.
- f. Advertising is permitted on the down and line-to-gain indicators. One manufacturer's logo or trademark is permitted on each indicator. Team/national and competition logos are allowed.

Markers or Obstructions

ARTICLE 8. a. # All markers and obstructions within the playing enclosure shall be placed or constructed in such a manner as to avoid any possible hazard to players. This includes anything dangerous to anyone at the limit lines.

- b. # After the officials' pregame inspection of the playing enclosure, the referee shall order removed any hazardous obstructions or markers located inside the limit lines.
- c. # The referee shall report to game management personnel any markers or obstructions constituting a hazard within the playing enclosure but outside the limit lines. Final determination of corrective action shall be the responsibility of game management personnel.
- d. # After the officials have completed their pregame inspection of the playing enclosure, it is the responsibility of game management personnel to ensure that the playing enclosure remains safe throughout the game.
- e. # Yardage line markers must be placed at least 12 feet outside the sidelines and should be collapsible and constructed in such a manner as to avoid any possible hazard to players. Yardage line markers on the goal lines must be placed at least 18 feet outside the sideline. Markers which do not conform to this standard shall be removed. Advertising on yardage line markers is permitted.

Field Surface

ARTICLE 9. a. # No material or device shall be used to improve or degrade the playing surface or other conditions and give one player or team an advantage (**Exception:** Rules 2-16-4-b and 2-16-4-c).

PENALTY – Live-ball foul. Five yards from the previous spot [S19: APS].

- b. # The referee may require any improvement in the field necessary for proper and safe game administration.

SECTION 3. The Ball

Specifications

ARTICLE 1. The ball shall meet the following specifications:

- a. # New or nearly new. (A nearly new ball is a ball that has not been altered and retains the properties and qualities of a new ball.)
- b. # Cover consisting of four panels of pebble-grained leather without corrugations other than seams.
- c. # One set of eight equally spaced lacings.
- d. # Natural tan colour.
- e. # Two 1-inch white stripes that are 3 to 3¼ inches from the end of the ball and located only on the two panels adjacent to the laces.
- f. # Conforms to maximum and minimum dimensions and shape indicated in the accompanying diagram. (*Exception:* The competition authority may authorise the use of a smaller ball for competitions involving female or junior players.)

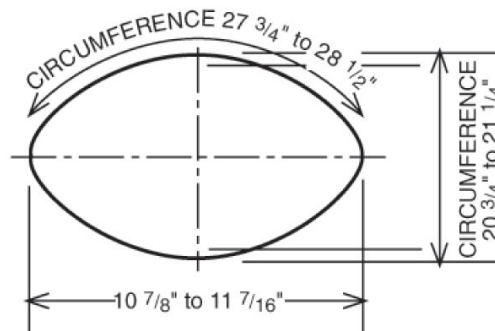

Diagram showing the longitudinal cross section of the standard ball. Maximum and minimum dimensions are used. This diagram is printed in order to secure uniformity in manufacture.

- g. # Inflated to the pressure of 12½ to 13½ pounds per square inch (psi).
- h. # Weight of 14 to 15 ounces.
- i. # The ball may not be altered. This includes the use of any ball-drying or ball-warming substance. Mechanical ball-drying and ball-warming devices are not permitted near the sidelines or in the team area.

Administration and Enforcement

- ARTICLE 2. a. The game officials shall test and be sole judge of not fewer than three and not more than six balls offered for play before and during the game. The game officials may approve additional balls if warranted by conditions.
- b. § Game management shall provide a pressure pump and measuring device.
 - c. # Unless provided by the competition authority, the home team shall provide a minimum of three legal balls and should notify the opponent of the ball to be used. The opponent may provide one or more legal balls in addition to those supplied by the home team if they wish to do so.
 - d. # During the entire game, both teams shall use only balls that meet the required specifications and have been measured and tested according to rule.
 - e. # All balls to be used must be presented to the referee for testing at least 60 minutes before the start of the game. Once the teams have presented the game balls to the referee, they remain under the general supervision of the officials throughout the game.

1. # The referee's first priority is to have three legal balls. If the competition authority or the home team does not provide at least three legal balls, the referee shall inform the away team and offer them the opportunity to provide legal balls. If fewer than three legal balls are provided, the game will proceed with only the legal ball(s) being used. If no legal balls are provided, the referee shall select up to three balls which in their judgement are the best available.
 2. # When more than three legal balls are presented, the referee shall select the balls in best condition from those presented by both teams.
- f. When the ball becomes dead outside the nine-yard marks/top of numbers, is unfit for play, is subject to measurement in a side zone or is inaccessible, a replacement ball shall be obtained from a ball person. **(A.R. 1-3-2:I)**
- g. The referee, centre judge or umpire shall determine the legality of each ball before it is put in play.
- h. The following procedures shall be used when measuring a ball:
1. All measurements shall be made after the ball is legally inflated.
 2. The long circumference shall be measured around the ends of the ball but not over the laces.
 3. The long diameter shall be measured with callipers from end to end but not in the nose indentation.
 4. The short circumference shall be measured around the ball, over the valve, over the lace, but not over the cross lace.

Approved Ruling 1-3-2

- i. On fourth down, kicker A1 enters the field with an approved game ball and asks the referee to substitute it for the ball used during the previous down. **RULING:** Substitution of the ball is not permitted. [Cited by 1-3-2-f]

Marking Balls

ARTICLE 3. Marking a ball indicating a preference for any player or any situation is unsportsmanlike conduct.

NOTE: If the person(s) subject to the rules who marked the ball cannot be immediately identified, charge the foul to the player(s) most likely to take advantage (e.g. the intended forward passer or kicker).

PENALTY – Live-ball foul. Fifteen yards from the previous spot [S27: UC-UNS].

SECTION 4. Players and Playing Equipment

Recommended Numbering

ARTICLE 1. It is strongly recommended that offensive players be numbered according to the following diagram that shows one of many offensive formations:



Players' Numbering

ARTICLE 2. a. All players shall be numbered 0 through 99. Any number preceded by the digit zero such as "099", "07" or "00" is illegal.

b. No more than one squad member may be assigned or wear the same jersey number (Rule 9-2-2-f).

c. Markings in the vicinity of the numbers are not permitted.

PENALTY – [a&c] Live-ball foul. Five yards from the previous spot [S23: IPN].

d. When a player enters the game after changing their jersey number or with a different number than on the game day roster, the player must report to the referee. The officiating crew informs the opposing head coach and the referee announces the change. A player who enters the game after changing their number or with a different number than on the game day roster and does not report commits a foul for unsportsmanlike conduct. **(A.R. 1-4-2:I)**

PENALTY – [d] Live-ball foul. 15 yards from the previous spot [S27: UC-UNS]. Flagrant offenders shall be disqualified [S47: DSQ].

Approved Ruling 1-4-2

i. The Team A player who started the game wearing jersey number 77 enters the game wearing number 88. **RULING:** The player must report to the referee who, without stopping the game or play clock, announces the change (using their microphone if available) and the relevant sideline official informs the opposing head coach. If A88 fails to report it is a foul for unsportsmanlike conduct. [Cited by 1-4-2-d]

Mandatory equipment

ARTICLE 3. All players must wear the following mandatory equipment:

- a. Helmet.
- b. Hip pads.
- c. Jersey.
- d. Knee pads.
- e. Mouthpiece.
- f. Pants.
- g. Shoulder pads.
- h. Socks.
- i. Thigh guards.

Specifications: Mandatory Equipment

ARTICLE 4. a. *Helmets.*

1. The helmet must be fitted with a face mask and a secured four- or six-point chin strap, all points of which must be secured whenever the ball is in play.
2. Helmets for all players of a team must be of the same colour and design.
3. Helmets must carry a warning label regarding the risk of injury and a manufacturer's or reconditioner's certification indicating satisfaction of National Operating Committee on Standards for Athletic Equipment (NOCSAE) test standards. Reconditioned helmets shall show recertification to indicate satisfaction with the NOCSAE test standard.

b. *Hip pads.* Hip pads must include a tailbone protector.

c. *Jersey.* See Rule 1-4-5.

d. *Knee pads.* Knee pads must be covered by pants. Furthermore, the pants and knee pads must cover the knees. No pads or protective equipment may be worn outside the pants. (See Appendix E.)

e. *Mouthpiece.* The mouthpiece must be an intra-oral device of any readily visible colour. It must not be white or transparent. It must be made with FDA-approved base materials (FDCA) and cover all upper teeth. It is recommended that the mouthpiece be properly fitted.

- f. *Pants*. Players of a team must wear pants of the same colour and design.
- g. *Shoulder pads*. There are no specifications for shoulder pads. (See Appendix E.)
- h. *Socks*. Players of a team must wear socks or leg coverings that are identical in colour and design. (**Exception:** Unaltered knee braces, tape or a bandage to protect or prevent an injury, and barefoot kickers) (**A.R. 1-4-4:I**)
- i. *Thigh guards*. There are no specifications for thigh guards. (See Appendix E.)

Approved Ruling 1-4-4

- l. A player or players of a team wear tights that cover their legs. **RULING:** Legal. For those players that wear tights, they must be of the same design and colour. [Cited by 1-4-4-h]

Jersey Design, Colour and Numerals

ARTICLE 5. a. Design

1. The jersey must have sleeves that completely cover the shoulder pads. It must not be altered or designed to tear. The jersey must be full-length and tucked into the pants or made even with the waistline. No other undergarment (e.g., T-shirt) shall extend below the waistline at the torso. The jersey must cover all pads worn at or above the waist. A second jersey meeting all requirements of Rule 1-4-5 worn concurrently is allowed. Vests and/or altered jerseys with zippers, Velcro, clasps or other fasteners are not allowed.
 2. Other than the player's numbers, the jersey may only contain:
 - Player's name in Latin script;
 - Team name in Latin script;
 - Sleeve stripes;
 - Logo for team, competition mascot, game memorial, or the military;
 - Authorised advertising material;
 - The letter "C" to identify a team captain;
 - The team's national flag.
 3. Any item in paragraph 2 must not exceed 16 square inches in area (i.e., rectangle, square, parallelogram), including any additional material (e.g. patch).
 4. A border around the collar and cuffs not more than 1 inch wide is permissible, as is a maximum 4-inch stripe along the side seam (insert from the underarm to pants top).
 5. Jerseys may not be taped or tied in any manner.
- b. Colour.
1. # Players of opposing teams shall wear jerseys of contrasting colours. Players on the same team shall wear jerseys of the same colour and design.
 2. Ø The visiting team shall wear white jerseys; however, the home team may wear white jerseys if the teams have agreed in writing before the start of the competition.
 3. # If the home team wears coloured jerseys, the visiting team may also wear coloured jerseys, if and only if the following two conditions have been satisfied:
 - (a) The home team has agreed in writing prior to the game; and
 - (b) The competition authority certifies that the jersey of the visiting team is of a contrasting colour.
 4. If on the kickoff at the start of each half, either team wears a coloured jersey in violation of the conditions specified above, it is a team foul for unsportsmanlike conduct. (**A.R. 1-4-7:III**)

PENALTY – Administer as a dead-ball foul. 15 yards at the succeeding spot following the kickoff. If the kickoff is returned for a touchdown, the penalty is assessed either on the try or on the succeeding kickoff, at the option of the offended team. [S27: UC-UNS] In addition, officials shall charge a team timeout at the start of each quarter the illegal jerseys are worn, or a foul for delay of the game if all timeouts have been used.

5. If a coloured jersey contains white, it may appear only as any of the items listed in paragraph a-2 above.

c. Numerals.

1. The jersey must have clearly visible, permanent Arabic numerals measuring at least 8 and 10 inches in height front and back, respectively. In addition, it is recommended that the jersey has a number on the outside of each shoulder measuring at least 3 inches in height. The number must be of a colour that itself is clearly in distinct contrast with the colour of the jersey, irrespective of any border around the number. The number must be centred. No logo may appear within 1 inch of the numerals.
2. Teams wearing jerseys/numerals that do not conform to this rule will be asked to change into legal jerseys before the game and before the start of the second half. On the kickoff at the start of each half, if a team wears a jersey in violation of the conditions specified in paragraph 1, it is a foul for unsportsmanlike conduct.

PENALTY – Administer as a dead-ball foul. 15 yards at the succeeding spot following the kickoff. If the kickoff is returned for a touchdown, the penalty is assessed either on the try or on the succeeding kickoff, at the option of the offended team. [S27: UC-UNS] In addition, officials shall charge a team timeout at the start of each quarter the illegal jerseys are worn, or a foul for delay of the game if all timeouts have been used. (A.R. 1-4-5:I)

3. All players of a team shall have the same colour and style numbers front and back. The individual bars must be approximately 1½ inches wide. Numbers on any part of the uniform shall correspond with the mandatory front and back jersey numbers.

Approved Ruling 1-4-5

- i. The home team is wearing red jerseys with orange numerals. In the judgment of the officials, the numerals and the body of the jersey do not contrast enough to make the numbers readily visible. The referee asks the home team head coach to change to a legal jersey. The head coach tells the referee that their team will not change into different jerseys. **RULING:** After the ball is declared ready for play for the opening kickoff, the referee charges the home team with a timeout for illegal jerseys. In addition, there will be a 15-yard penalty at the succeeding spot following the kickoff starting each half. If the kickoff is returned for a touchdown, the penalty is assessed either on the try or at the succeeding kickoff. For each quarter that they continue to wear the jerseys, the team is charged with a timeout after the ball is declared ready for play and before the ball is put in play for the first play of that quarter. If a team has no timeouts remaining, a delay of game penalty will be enforced. [Cited by 1-4-5 Penalty]

Optional equipment

ARTICLE 6. The following items are legal:

a. *Towels and hand warmers.*

1. Solid colour towels no smaller than 4 inches by 12 inches and no larger than 6 inches by 12 inches with no words, symbols, letters, or numbers. Towels may bear the team logo. They may also contain a single manufacturer's or distributor's normal label or trademark not to exceed 2-¼ square inches in area. Towels that are not a solid colour are not permitted. **(A.R. 1-4-7:V)**

2. Hand warmers worn during inclement weather.

b. *Gloves.*

1. A glove is a fitted covering for a hand having separate sections for each finger and thumb, without any additional material that connects any of the fingers and/or thumb. There is no restriction on the colour of gloves.
2. Gloves should have a securely attached label or stamp ("NF/NCAA Specifications") indicating voluntary compliance with appropriate test specifications on file with either the Sports and Fitness Industry Association (SFIA) or the National Operating Committee on Standards for Athletic Equipment (NOCSAE), unless made of unaltered plain cloth.

- c. *Eye shields*. Eye shields must be clear, not tinted, and made from moulded or rigid material. Eyeglasses and goggles also must be clear and not tinted. No medical exceptions are allowed. Eyewear is not clear if it obscures a player's eyes at any time from any angle or in any light condition. "Mirrored" eyewear is expressly prohibited. **(A.R. 1-4-8:II)**
- d. *Insignia*.
 - 1. Persons or events may be memorialised by an insignia with an area not greater than 16 square inches on the uniform or helmet.
 - 2. Team/national decals and advertising are allowed on helmets.
- e. *Eye shade*. Any shading under a player's eyes must be solid black with no words, numbers, logos or other symbols.
- f. *Game information*. Any player may have written game information on the wrist, arm or belt.

Illegal equipment

ARTICLE 7. Illegal equipment includes the following (see Appendix E for additional details):

- a. Equipment worn by a player that could endanger other players.
- b. Tape or any bandage other than that used to protect or prevent an injury, subject to the approval of the umpire.
- c. Hard, abrasive or unyielding equipment that is not completely covered and padded, subject to the approval of the umpire.
- d. Cleats that extend more than ½ inch from the base of the shoe (See Appendix E for full specifications).
- e. Any equipment that could confuse or deceive an opponent.
- f. Any equipment that could provide an unfair advantage to any player.
- g. Adhesive material, paint, grease or any other slippery substance applied to equipment or on a player's person, clothing or attachment (**Exception:** Eye shade (Rule 1-4-6-e)).
- h. Uniform attachments other than towels (Rule 1-4-6-a).
- i. Rib pads, shoulder pad attachments and back protectors that are not totally covered. **(A.R. 1-4-7:II) (A.R. 1-4-8:III)**
- j. Visible bandannas worn on the field outside the team area. **(A.R. 1-4-7:I)**
- k. Jerseys that do not conform with Rule 1-4-5.
- l. Non-standard overbuilt face mask. **(A.R. 1-4-7:IV)** (See Appendix E for examples.)
- m. Equipment that has been modified in a way that reduces the protection of the player wearing it or any other participant.
- n. Hoodies, if the hood is outside the shoulder pad and overlapping the jersey.

Approved Ruling 1-4-7

- I. A33 is wearing a bandanna under their helmet, with part of the bandanna protruding from underneath the back of the helmet. **RULING:** Illegal equipment. Bandannas may be worn under the helmet as long as no part of the bandanna is visible when the helmet is in place. The visible bandanna is considered a uniform attachment (Rule 1-4-7-h). A33 must leave the game for at least one down and may not return until the bandanna is removed or completely hidden under the helmet. Team A may request a team timeout, if one is available, to prevent A33 from missing a down, but the bandanna must be hidden or removed. [Cited by 1-4-7-j]
- II. At the end of a down, B55's shoulder pad has become exposed and is not covered by the jersey. **RULING:** Illegal equipment. Because the pad became exposed through play, B55 is not required to leave the game. The pad must be covered by the jersey before the ball is next put into play. [Cited by 1-4-7-i, 1-4-8-c]
- III. Both teams come onto the field before the game wearing coloured jerseys. The visiting team has not obtained written agreement from the home team to wear non-white jerseys, or if such agreement has been obtained the competition authority has not certified that the jerseys are of contrasting colours.

RULING: Foul by the visiting team for violation of the jersey-colour rule. After the ball is declared ready for play for the opening kickoff, the referee charges the visiting team with a timeout for illegal jerseys. In addition, there will be a 15-yard penalty at the succeeding spot following the kickoff starting each half. If the kickoff is returned for a touchdown, the penalty is assessed either on the try or at the succeeding kickoff. For each quarter that they continue to wear the jerseys, the team is charged with a timeout after the ball is declared ready for play and before the ball is put in play for the first play of that quarter. If a team has no timeouts remaining, a delay of game penalty will be enforced. (Rule 1-4-5-b) [Cited by 1-4-5-b-4]

- IV. As Team A is about to break its huddle, the referee notices that A35 is wearing an overbuilt face mask. **RULING:** A35 must leave the game for one down to get a legal face mask. Team A may use an available charged timeout in order that A35 not miss a down, but they may not play with the illegal face mask. [Cited by 1-4-7-I]
- V. Each member of the offensive line is wearing a towel, all of which are white, 4" by 12", with a small team logo. The snapper's towel also has a large skull-and-cross-bones symbol. **RULING:** It is legal for any player to wear a towel. The towels are all legal except the snapper's. They must leave the game for at least one down and may not return until the towel is removed or replaced with one that is legal. Team A may keep them in the game by using a charged timeout, but they may not wear the illegal towel. (Rules 1-4-6-a and 1-4-8) [Cited by 1-4-6-a-1]

Mandatory and Illegal Equipment Enforcement

- ARTICLE 8. a. No player wearing illegal equipment or failing to wear mandatory equipment shall be permitted to play. (**Exception:** Rules 1-4-5-b and 1-4-5-c).
- b. If an official discovers illegal equipment, or if a player is not wearing mandatory equipment, the player must leave the game for at least one down and is not allowed to return until the equipment is made legal. The player may be allowed to return without missing a down if the team takes a charged team timeout, but in any event the player may not play with illegal equipment or without mandatory equipment. (**A.R. 1-4-8:I-II and IV**)
- c. If equipment becomes illegal through play, the player is not required to leave the game for one down, but the player may not participate until the equipment is made legal. (**A.R. 1-4-7:II**) (**A.R. 1-4-8:III**)
- d. If an official notifies a player to leave the field, but the player does not respond by doing so after two notifications, a timeout shall be charged to the team. Each of the first three infractions in a half carries a charged team timeout, if timeouts are available. Any infraction after a team has exhausted its timeouts is a foul for delay of game and carries a five-yard penalty. (**A.R. 1-4-8:IV**).
1. If a timeout is available, it is granted. When timeouts are exhausted, the next infraction is a dead-ball delay penalty at the succeeding spot.
 2. A timeout is called, the offending team is indicated by the referee, then the captains and head coaches are notified through the officials nearest to them.
 3. Equipment timeouts are not limited by the prohibition on consecutive team timeouts (Rule 3-3-4) but the additional one minute is not granted.

Approved Ruling 1-4-8

- I. After the ball is ready for play, an official identifies a player(s) (a) who is obviously not wearing a mouthpiece or (b) whose mouthpiece is hanging from their face mask. **RULING:** (a) The player(s) must leave the game for at least one down and may not return until properly equipped with a mouthpiece. The player(s) may remain in the game by spending an available team timeout, but they may not play until properly equipped. (b) The official notifies the player. If the player does not respond by wearing the mouthpiece correctly after two notifications, a timeout or delay penalty will be charged to their team. [Cited by 1-4-8-b]
- II. Late in the first half, Team B has used its three timeouts. At the end of a play the line judge notices that B44, a player who participated in the previous play, is equipped with an eye shield that is either tinted or not clear. **RULING:** Equipment violation. B44 must leave the game for at least one down and may not return if they are still wearing an illegal eye shield. [Cited by 1-4-6-c, 1-4-8-b]

- III. When the ball is dead after a scrimmage down, the umpire notices that linebacker B55 has an exposed back pad at waist level, which apparently became exposed through play during the previous down. **RULING:** B55 is not required to leave the game, but they must cover the exposed pad with their jersey before the next down. [Cited by 1-4-7-i, 1-4-8-c]
- IV. An official discovers a player wearing illegal equipment or not wearing mandatory equipment (other than a helmet coming completely off through play - Rule 3-3-10). **RULING:** The official notifies the player that they must leave the game. If the player responds by starting to leave the field, the official is not to stop either the game clock or the play clock. If possible, the referee will use their microphone to make a brief announcement identifying the player and their team and the reason why they must leave the field. This announcement should be made from the referee's position to officiate the next play, and must not delay the start of the next play. However, if the player does not respond after two notifications or stops before leaving the field, the official shall blow their whistle and signal to stop the clock and the offending team will be charged with a timeout (or a delay penalty if all timeouts are exhausted). [Cited by 1-4-8-b, 1-4-8-d]

Coaches' Certification

ARTICLE 9. # The head coach or their designated representative shall certify in writing to the umpire before the game that all players:

- a. # Have been informed what equipment is mandatory by rule and what constitutes illegal equipment.
- b. # Have been provided with the equipment mandated by rule.
- c. # Have been instructed to wear and how to wear mandatory equipment during the game.
- d. # Have been instructed to notify the coaching staff when equipment becomes illegal through play during the game.

Prohibited Signal Devices

ARTICLE 10. Players may not be equipped with any wearable electronic, mechanical or other signal devices for the purpose of communicating with any source or recording sound or vision (**Exceptions:**

1. A medically prescribed hearing aid of the sound-amplifier type for hearing-impaired players.
2. A device for transmission or reception of data specifically and only for the purposes of health and safety.)

PENALTY – Administer as a dead-ball foul, 15 yards at the succeeding spot. Player is disqualified. [S7, S27, S47: UC-UNS/DSQ].

Prohibited Field Equipment

ARTICLE 11. Jurisdiction regarding the presence and location of communication equipment (cameras, sound devices, etc.) within the playing enclosure resides with game management personnel.

- a. # Photographs (digital or otherwise), computers and other electronic communication devices are permitted for coaching purposes during the game or between periods. They may not be used in the field of play or end zones.
 1. # Game management is responsible for assuring identical television capability and identical video and Internet connectivity in the team area and in the coaches' booths of both teams.
 2. # Teams are responsible for their own computers or other coaching equipment.
 3. # A monitor is permitted on the sideline to assist team or game management medical personnel in the diagnosis and treatment of participants.
- b. # Only voice or text communication between the press box and team area is permitted. Coaches' booth space and location must be approximately equivalent for both teams and should be located in the press box area. Where press-box space is not adequate, only voice or text communication may originate from any area in the stands between the 20-yard lines extended to the top of the stadium. No other communication for coaching purposes is permitted anywhere else, including the use of any communication equipment (e.g. mobile phones or radios) for voice, text, image or any other

type of message from inside or outside the playing enclosure by or to any person subject to the rules (remote coaching). **(A.R. 1-4-11:I)**

- c. # Media communication or recording equipment, including cameras, sound devices, computers and microphones, is prohibited on or above the field, or in or above the team area (Rule 2-31-1).

Exceptions:

1. Camera equipment attached to a goal support behind the uprights and crossbar.
2. Camera(s) embedded in any pylon.
3. A camera, with no audio component, may be attached to the uniform or equipment of any official with prior approval of the official and either the competition authority or the participating teams.

NOTE: Cameras worn by officials solely for the purposes of officiating development may be worn by any official without requiring the permission of the competition authority or the participating teams.

4. A camera, with no audio component, may be attached to cables that extend over the team area and field of play, including the end zones.
 5. A team videographer may be in the team area as one of that team's 25 credentialed individuals. This video may not be used during any live broadcast or digital stream of the game.
- d. # Drone (uncrewed aerial vehicle) use is prohibited for any purpose, including videoing the game, during the period of the officials' jurisdiction (Rule 11-1-1) or otherwise when squad members are present within the playing enclosure.
1. No drone may be flown within the area bounded by the stadium, dome, stands, fences or other structures. Where there is no stadium, dome or stands, no drone may be flown within 165 yards (150 metres) of any area occupied by participants or spectators.
 2. If a drone violates this space or otherwise poses a danger to participants or spectators, the referee shall order the game stopped until such time as the drone is removed from the space.
- e. # Microphones attached to coaches during the game for media transmission or recording are prohibited.
- f. # No one in the team area or coaching box may use any artificial sound amplification for communication.
- g. Any attempt to record, either through audio or video means, any signals given by an opposing player, coach or other team personnel is prohibited.

Approved Ruling 1-4-11

- i. The head coach of the home team is unable to attend the game in person and wants to monitor the TV broadcast and (a) call in plays via mobile phone to the offensive coordinator and (b) use a virtual application (Zoom, Microsoft Teams, etc.) to communicate with the team in the locker room. **RULING:** Rule 1-4-11-b is specific and allows only voice communication between the press box and the team area, therefore in (a) the coach could not call into the press box or the sideline for anything related to coaching purposes. Although Rule 1-4-11-a allows the use of technology by coaches, this only applies to coaches present within the playing enclosure (Rule 2-27-16-a). Consequently in (b) any virtual session with the team would not be allowed. This prohibition would begin at 60 minutes before the scheduled kickoff when the officiating crew assumes jurisdiction of the game and would include the time between periods until the end of the game when the referee declares the score final. [Cited by 1-4-11-b]

Coaches' Phones, Headsets and Communication Devices

ARTICLE 12. # Coaches' phones, headsets and communication devices are not subject to playing rules penalties before or during the game.

- a. ∅ A competition may develop a policy to provide guidance in handling situations dealing with failure of coaches' headsets.

Referee communication

- ARTICLE 13. a. § A microphone is strongly recommended for the referee to be used for all game announcements. It is strongly recommended that it be a lapel-type microphone. The microphone must be controlled by the referee. It may not be open at other times.
- b. A wireless communication system open only to the officiating crew, video judge and the officiating observer is permitted.
 - c. No person subject to the rules is permitted to eavesdrop wireless communication between officials before, during or after the game.

PENALTY – For fouls before or during the game, administer as a dead-ball foul, 15 yards at the succeeding spot. Person is disqualified. Fouls after the game shall be reported as misconduct.

Accessibility

- ARTICLE 14. a. In the interests of accessibility, national federations may approve on a case-by-case basis applications to:
1. permit a participant to use prosthetics during games
 2. permit a reasonable adjustment to [the field](#), uniform and equipment rules for a disabled participant
 3. permit a person to participate in a gender different to that assigned to them at birth
- b. To be approved, it must be demonstrated via a risk assessment that this:
1. does not pose an undue risk to the participant
 2. does not pose any additional risk to other participants
 3. does not convey an unfair competitive advantage to the participant or their team
- c. Approvals must be notified to potential opponents and relevant officials. Approvals must be notified to IFAF in the case of people who intend to participate in international competitions.

RULE 2

Definitions

SECTION 1. Approved Rulings and Official's Signals

- ARTICLE 1. a. An Approved Ruling (A.R.) is an official decision on a given statement of facts. It serves to illustrate the spirit and application of the rules.
- b. An official's signal [S] refers to the Official Football Signals 1 through 47.

SECTION 2. The Ball: Live, Dead, Loose, Ready For Play

Live Ball

ARTICLE 1. A live ball is a ball in play. A pass, kick or fumble that has not yet touched the ground is a live ball in flight.

Dead Ball

ARTICLE 2. A dead ball is a ball not in play.

Loose Ball

- ARTICLE 3. a. A loose ball is a live ball not in player possession during:
1. A running play.
 2. A scrimmage or free kick before possession is gained or regained or the ball is dead by rule.
 3. The interval after a legal forward pass is touched and before it becomes complete, incomplete or intercepted. This interval is during a forward pass play, and any player eligible to touch the ball may bat it in any direction.
- b. All players are eligible to touch, catch or recover a fumble (*Exceptions:* Rules 7-2-2-a Exception 2 and 8-3-2-d-5) or a backward pass.
- c. Eligibility to touch a kick is governed by kick rules (Rule 6).
- d. Eligibility to touch a forward pass is governed by pass rules (Rule 7).

When Ball is Ready for Play

- ARTICLE 4. A dead ball is ready for play when:
- a. With the 40-second play clock running, an official places the ball at a hash mark or between the inbounds marks and is in position to officiate.
 - b. With the play clock set at 25 seconds, or at 40 seconds after an injury to or loss of helmet by a defensive team player, the referee sounds their whistle and either signals to start the game clock [S2] or signals that the ball is ready for play [S1]. (**A.R. 4-1-4:I and II**)

SECTION 3. Blocking

Blocking

- ARTICLE 1. a. Blocking is obstructing an opponent by intentionally contacting the opponent with any part of the blocker's body.
- b. Pushing is blocking an opponent with open hands.
- c. Continuous contact is a block where contact with an opponent is maintained for more than one second.

Below Waist

- ARTICLE 2. a. A block below the waist is a block in which the force of the initial contact is below the waist of an opponent who has one or both feet on the ground. When in question, the contact is below the waist (Rule 9-1-6).
- b. A blocker who makes contact above the waist and then slides below the waist has not blocked below the waist. If the blocker first contacts the opposing player's hands at the waist or above, it is a legal "above the waist" block (Rule 9-1-6).

Chop Block

ARTICLE 3. A chop block is a high-low or low-high combination block by any two players against an opponent (not the ball carrier) anywhere on the field, with or without a delay between blocks; the "low" component is at the opponent's thigh or below. (A.R. 9-1-10:I-IV) It is not a foul if the blockers' opponent initiates the contact. (A.R. 9-1-10:V)

Block in the Back

- ARTICLE 4. a. A block in the back is contact against an opponent occurring when the force of the initial contact is from behind and above the waist. When in question, the contact is at or below the waist (see Clipping, Rule 2-5) (Rule 9-3-5). (A.R. 9-3-3:I,V-VII,IX) (A.R. 10-2-2:XII,XVII)
- b. The position of the blocker's head or feet does not necessarily indicate the point of initial contact.

Frame of the body

ARTICLE 5. The frame of a player's body is at the shoulders or below other than the back (Rule 9-3-3-a-1-b Exception).

Free-blocking zone

- ARTICLE 6. a. The free-blocking zone is a rectangle centred on the snapper and extending five yards laterally and three yards longitudinally in each direction. (See Appendix D.)
- b. The free-blocking zone disintegrates when the ball leaves the zone.

Blind-side block

ARTICLE 7. A blind-side block is an open field block against an opponent that is initiated from outside the opponent's field of vision, or otherwise in such a manner that the opponent cannot reasonably defend themselves against the block.

SECTION 4. Catch, Recovery, Possession

Possession

ARTICLE 1. Possession refers to custody of (a) a live ball as described later in this article or (b) a dead ball to be snapped or free-kicked. It may refer either to player possession or team possession.

a. Player possession

The ball is in player possession when a player has the ball firmly in their grasp by holding or controlling it with hand(s) or arm(s) while contacting the ground inbounds.

b. Team possession

The ball is in team possession:

1. When one of its players has player possession, including when they are attempting a punt, drop kick or place kick; or
2. While a forward pass thrown by a player of that team is in flight; or
3. During a loose ball if a player of that team last had player possession; or
4. When the team is next to snap or free kick the ball.

- c. A team is in legal possession if it has team possession when its players are eligible to catch or recover the ball.

Belongs To

ARTICLE 2. "Belongs to", as contrasted with "in possession", denotes custody of a dead ball. Such custody may be temporary, because the ball must next be put in play in accordance with rules governing the existing situation.

Catch, Interception, Recovery

ARTICLE 3. a. To catch a ball means that a player:

1. Secures firm control with the hand(s) or arm(s) of a live ball in flight before the ball touches the ground, and
 2. Touches the ground in bounds with any part of their body, and then
 3. Maintains control of the ball long enough to enable them to perform an act common to the game, i.e., long enough to pitch or hand the ball, advance it, avoid or ward off an opponent, etc., and
 4. Satisfies paragraphs b, c and d below.
- b. If a player goes to the ground in the act of catching a pass (with or without contact by an opponent), they must maintain complete and continuous control of the ball throughout the process of contacting the ground, whether in the field of play or in the end zone. This is also required for a player attempting to make a catch at the sideline and going to the ground out of bounds. If they lose control of the ball which then touches the ground before they regain control, it is not a catch. If they regain control inbounds prior to the ball touching the ground, it is a catch (**A.R. 7-3-6:IX-XV**).
- c. If the player loses control of the ball while simultaneously touching the ground with any part of their body, or if there is doubt that the acts were simultaneous, it is not a catch. If a player has control of the ball, a slight movement of the ball, even if it touches the ground, will not be considered loss of possession; they must lose control of the ball in order for there to be a loss of possession.
- d. If the ball touches the ground after the player secures control and continues to maintain control, and the elements above are satisfied, it is a catch.
- e. An interception is a catch of an opponent's pass or fumble.
- f. A catch by any kneeling or prone inbounds player is a completion or interception (Rule 7-3-6).
- g. A player recovers a ball if they fulfil the criteria in paragraphs a, b, c, and d for catching a ball that is still alive after hitting the ground.
- h. When in question, the catch, recovery or interception is not completed.

Approved Ruling 2-4-3

- I. B1 attempts to catch a punt (no fair catch signal) that crosses the neutral zone, strikes their shoulder (a muff) and bounces into the air. The ball does not touch the ground. Airborne A1 receives the ball in flight and first returns to the ground out of bounds. **RULING:** Team B's ball at the spot where the ball crossed the sideline. First and 10.
- II. On third down, B1 blocks a Team A scrimmage kick that goes into the air and does not cross the neutral zone. The ball does not touch the ground. A1 jumps and grasps the ball in flight and first returns to the ground out of bounds. **RULING:** Team B's ball at the spot where the ball crossed the sideline. First and 10 (Rule 6-3-7).
- III. Airborne A3 receives a pass at Team A's 40-yard line. While still airborne, they are contacted by B1 and come to the ground out of bounds with the ball at Team A's 37-yard line. **RULING:** Incomplete pass (Rule 7-3-7-a). [Cited by 7-3-6, 7-3-7-a]
- IV. Receiver A88 is near the sideline, stretching to catch a legal forward pass. As A88 is going to the ground in the act of catching the pass, (a) A88 gains firm control of the ball with the toes down in bounds and falls

out of bounds, maintaining firm control; (b) A88 gains firm control of the ball with toes down in bounds, bobbles the ball while airborne, regains firm control before landing out of bounds and maintains firm control when landing; (c) A88 gains firm control of the ball with toes down in bounds, falls out of bounds and loses firm control of the ball when contacting the ground. **RULING:** (a) Catch by A88. (b) Incomplete pass. (c) Incomplete pass.

- V. On second down, A1 fumbles the ball, which strikes the ground and bounces high in the air. B2 receives the ball while off the ground and returns to the ground out of bounds (a) in advance of the spot of the fumble or (b) behind the spot of the fumble. **RULING:** (a) Team A's ball at the spot of the fumble. (b) Team A's ball at the spot where the ball crossed the sideline (Rules 4-2-4-d and 7-2-4).

Simultaneous Catch or Recovery

ARTICLE 4. A simultaneous catch or recovery is a catch or recovery in which there is joint possession of a live ball by opposing players inbounds. (A.R. 7-3-6:I-II)

SECTION 5. Clipping

- ARTICLE 1. a. Clipping is a block against an opponent in which the force of the initial contact is from behind and at or below the waist (Rule 9-1-5).
- b. The position of the blocker's head or feet does not necessarily indicate the point of initial contact.

SECTION 6. Deliberate Dead-Ball Advance

Deliberately advancing a dead ball is an attempt by a player to advance the ball after any part of their body, other than a hand or foot, has touched the ground or after the ball has been declared dead by rule (*Exception:* Rule 4-1-3-b Exception).

SECTION 7. Down, Between Downs and Loss of Down

Down

ARTICLE 1. A down is a unit of the game that starts after the ball is ready for play with a legal snap (scrimmage down) or legal free kick (free kick down) and ends when the ball becomes dead [*Exception:* The try is a scrimmage down that begins when the ball is declared ready for play (Rule 8-3-2-b)].

Between Downs

ARTICLE 2. Between downs is the interval during which the ball is dead.

Loss of down

ARTICLE 3. "Loss of down" is an abbreviation meaning "loss of the right to repeat a down".

SECTION 8. Fair Catch

Fair Catch

- ARTICLE 1. a. A fair catch of a scrimmage kick is a catch beyond the neutral zone by a Team B player who has made a valid signal during a scrimmage kick that is untouched beyond the neutral zone.
- b. A fair catch of a free kick is a catch by a Team B player who has made a valid signal during an untouched free kick.
- c. A valid or invalid fair catch signal deprives the receiving team of the opportunity to advance the ball. The ball is declared dead at the spot of the catch or recovery. If the catch or recovery precedes the signal, the ball is dead when the signal is first given.
- d. If the receiver shades their eyes from the sun without waving their hand(s), the ball is live and may be advanced.

Valid Signal

ARTICLE 2. A valid signal is a signal given by a player of Team B who has obviously signalled their intention by extending one hand only clearly above their head and waving that hand from side to side of their body more than once.

Invalid Signal

ARTICLE 3. An invalid signal is any waving signal by a player of Team B:

- a. That does not meet the requirements of Rule 2-8-2 (above); or
- b. Including a "T" signal given during a free kick or scrimmage kick (A.R. 6-5-3:VII); or
- c. That is given after a scrimmage kick is caught beyond the neutral zone, strikes the ground or touches another player beyond the neutral zone (A.R. 6-5-3:III-V); or
- d. That is given after a free kick is caught, strikes the ground or touches another player (*Exception:* Rule 6-4-1-f).

Approved Ruling 2-8-3

- I. During Team A's punt from the A-20, receiver B44 points at the grounded punt at midfield. As B44 points at the ball, (a) they keep their hands below their shoulders with no waving motion; (b) they keep their hands below their shoulders and have a waving motion; (c) they have their hands just above the shoulders with no waving motion. **RULING:** Rule 2-8-3 states that any waving motion that does not meet the criteria for a valid signal is an invalid signal. Additionally, by interpretation the receiver is allowed to point at a kick as long as their hands remain below the shoulder and there is no waving motion. Both (b) and (c) would be an invalid fair catch signal. In (a), this would not be considered a signal at all, and Team B would retain the right to recover the ball and advance.
- II. Free Kick @ A-35. The kickoff is high and deep, and deep receiver B21 gives the "T signal" as the kick is in flight. B21 catches the kick right at the goal line and returns the kick back to the B-35. **RULING:** The "T signal" is considered an invalid fair catch signal and the ball is dead when caught. The crew should shut the play down after B21 gains possession. Team B's ball 1/10 @ B-25.

SECTION 9. Forward, Beyond and Forward Progress

Forward, Beyond

ARTICLE 1. Forward, beyond or in advance of, as related to either team, denotes direction toward the opponent's end line. Converse terms are backward or behind.

Forward Progress

ARTICLE 2. Forward progress is a term indicating the end of advancement by the ball carrier or airborne pass receiver of either team and applies to the position of the ball when it becomes dead by rule (Rules 4-1-3-a, 4-1-3-b, 4-1-3-p and 4-1-3-r; Rules 4-2-1 and 4-2-4; and Rule 5-1-3-a Exceptions) (A.R. 5-1-3:I-VI) (A.R. 8-2-1:I-IX) (*Exception:* Rule 8-5-1-a (A.R. 8-5-1:I)).

SECTION 10. Foul and Violation

Foul

ARTICLE 1. A foul is a rule infraction for which a penalty is prescribed.

Personal Foul

ARTICLE 2. A personal foul is a foul involving illegal physical contact that endangers the safety of another player.

Flagrant Personal Foul

ARTICLE 3. A flagrant personal foul is illegal physical contact so extreme or deliberate that it places an opponent in danger of catastrophic injury.

Approved Ruling 2-10-3

- I. What is a "catastrophic" injury? **RULING:** The National Center for Catastrophic Sport Injury Research in the USA defines a catastrophic injury as: "fatalities, injuries that result in permanent functional disability, and serious injuries that result in temporary functional disability with full recovery. Examples include spinal cord injuries, brain bleeds, skull fractures, heat stroke, sudden cardiac arrest, internal organ injuries, exertional sickling [exercise collapse associated with sickle cell disease], rhabdomyolysis [rapid dissolution of damaged or injured skeletal muscle], and commotio cordis [ventricular fibrillation precipitated by blunt trauma to the heart]." Note that the flagrant personal foul does not have to *cause* such an injury - it is sufficient for the foul to place the recipient in *danger* of such an injury.

Violation

ARTICLE 4. A violation is a rule infraction for which no penalty is prescribed. Since it is not a foul, it does not offset a foul.

SECTION 11. Fumble, Muff; Batting and Touching the Ball; Blocking a Kick

Fumble

ARTICLE 1. To fumble the ball is to lose player possession by any act other than passing, kicking or successful handing. (A.R. 2-19-2:I) (A.R. 4-1-3:I) The status of the ball is a fumble.

Muff

ARTICLE 2. To muff the ball is to touch the ball in an unsuccessful attempt to catch or recover it. Muffing the ball does not change its status.

Batting

ARTICLE 3. Batting the ball is intentionally striking it or intentionally changing its direction with the head, hand(s) or arm(s). When in question, the ball is accidentally touched rather than batted. Batting the ball does not change its status.

Touching

- ARTICLE 4. a. Touching a ball not in player possession denotes any contact with the ball. It may be intentional or unintentional, and it always precedes possession and control.
- b. Intentional touching is deliberate or intended touching.
 - c. Forced touching results when a player's contact with the ball is due to (i) an opponent blocking that player into it, or (ii) the ball being batted or illegally kicked into that player by an opponent. If the touching is forced, by rule the player in question has not touched the ball (Rules 6-1-4 and 6-3-4).
 - d. When in question, a ball has not been touched on a kick or forward pass.

Approved Ruling 2-11-4

- I. A punt is rolling along the ground near players A44 and B27 who are engaged. (a) The ball bounces against B27's leg and is then recovered by A55 at the B-35. (b) A44 blocks B27 into the ball which is then recovered by A55 at the B-35. **RULING:** (a) Team A's ball, first and 10 at the B-35. The ball rolled into B27's leg but A44's contact did not cause them to touch the ball. Not forced touching. (b) Forced touching because the block by A44 caused B27 to touch the ball. Illegal touching by A55. Team B's ball at that point. [Cited by 6-1-4-a, 6-3-4-a]

Blocking a Scrimmage Kick

ARTICLE 5. Blocking a scrimmage kick is touching the kicked ball by an opponent of the kicking team in an attempt to prevent the ball from crossing the neutral zone (Rule 6-3-1-b).

SECTION 12. Lines

Sidelines

ARTICLE 1. A sideline runs from end line to end line on each side of the field and separates the field of play from the area that is out of bounds. The entire sideline is out of bounds.

Goal Lines and Pylons

ARTICLE 2. The goal line at each end of the field of play runs between the sidelines and is part of the vertical plane that separates the end zone from the field of play. The two goal lines are 100 yards apart (normally). The plane of the goal line extends between and includes the pylons, which are out of bounds. The entire goal line is in the end zone. A team's goal line is that which it is defending.

Approved Ruling 2-12-2

- I. Team A's untouched scrimmage kick strikes the ground in the field of play and breaks the plane of Team B's goal line. While the ball is in the air over the end zone, A81, who is either on the one-yard line or in the end zone, bats the ball into the field of play. **RULING:** Violation for illegal touching (Rule 6-3-11). Team B may accept the result of the play or next snap the ball at its 20-yard line (Exception: Rule 8-4-2-b). [Cited by 6-3-11, 6-3-2-a]

End Lines

ARTICLE 3. An end line runs between the sidelines normally 10 yards behind each goal line and separates the end zone from the area that is out of bounds. The entire end line is out of bounds.

Boundary Lines

ARTICLE 4. The boundary lines are the sidelines and the end lines. The area enclosed by the boundary lines is "in bounds", and the area surrounding and including the boundary lines is "out of bounds".

Restraining Lines

ARTICLE 5. A restraining line is part of a vertical plane that limits a team's alignment for free kicks. The plane extends beyond the sidelines. (**A.R. 2-12-5:I**)

Approved Ruling 2-12-5

- I. A free kick breaks the plane of Team B's restraining line. While the ball is in the air, A1, who is behind Team B's restraining line, touches the ball. **RULING:** Legal touching (Rule 6-1-3-a-2). [Cited by 2-12-5, 6-1-3-a-2]

Yard Lines

ARTICLE 6. A yard line is any line in the field of play parallel to the end lines. A team's own yard lines, marked or unmarked, are numbered consecutively from its own goal line to the midfield line.

Hash Marks

ARTICLE 7. The two hash marks are 60 feet from the sidelines. Hash marks and short yard-line extensions shall measure 24 inches in length.

Nine-Yard Marks

ARTICLE 8. Nine-yard marks 12 inches in length, every 10 yards, shall be located nine yards from the sidelines. They are not required if the field is numbered according to Rule 1-2-1-j.

SECTION 13. Handing the Ball

- ARTICLE 1. a. Handing the ball is transferring player possession from one teammate to another without throwing, fumbling or kicking it.
- b. Except when permitted by rule, handing the ball forward to a teammate is illegal.
- c. Loss of player possession by unsuccessful execution of attempted handing is a fumble by the last player in possession (**Exception:** The snap (Rule 2-23-1-c)).
- d. A backward handoff occurs when the ball carrier releases the ball before it is beyond the yard line where the ball carrier is positioned.

SECTION 14. Huddle

A huddle is two or more players grouped together after the ball is ready for play and before a snap or a free kick.

SECTION 15. Hurdling

- ARTICLE 1. a. Hurdling is an attempt by a player to jump with one or both feet or knees foremost over an opponent while that opponent is still on their feet (Rule 9-1-13).
- b. "On their feet" means that no part of the opponent's body other than one or both feet is in contact with the ground.

SECTION 16. Kicks; Kicking the Ball

Kicking the Ball; Legal and Illegal Kicks

- ARTICLE 1. a. Kicking the ball is intentionally striking the ball with the knee, lower leg or foot.
- b. A legal kick is a punt, drop kick or place kick made according to the rules by a player of Team A before a change of team possession. Kicking the ball in any other manner is illegal.
(**A.R. 6-1-2:I**)
- c. Any free kick or scrimmage kick continues to be a kick until it is caught or recovered by a player or becomes dead.
- d. When in question, a ball is accidentally touched rather than kicked.

Punt

ARTICLE 2. A punt is a kick by a player who drops the ball and kicks it before it touches the ground.

Drop Kick

ARTICLE 3. A drop kick is a kick by a player who drops the ball and kicks it as it touches the ground.

Place Kick

- ARTICLE 4. a. A field goal place kick is a kick by a player of the team in possession while the ball is controlled on the ground by a teammate (Rule 2-16-9).
- b. A tee is a device that elevates the ball for kicking purposes. It may not elevate the ball's lowest point more than one inch above the ground (**A.R. 2-16-4:I**). If utilized, a tee must be in contact with the ball for the kick to be legal.
- c. A free kick place kick is a kick by a player of the team in possession while the ball is positioned on a tee or the ground. It may be controlled by a teammate. The ball may be positioned on the ground and contacting the tee.
- d. No device or material may be used to mark the spot of a scrimmage place kick or to elevate the ball. This is a live-ball foul at the snap (Rule 6-3-10-d).

Approved Ruling 2-16-4

- l. On a free kick to start a game, the kicker uses the toe of a teammate for a tee or builds a tee with a mound of dirt or sod. **RULING:** Illegal kick. Dead-ball foul. Penalty — Five yards from the succeeding spot. [Cited by 2-16-4-b, 4-1-1]

Free Kick

- ARTICLE 5. a. A free kick is a kick by a player of the team in possession made under restrictions specified in Rules 4-1-4, 6-1-1 and 6-1-2.
- b. A free kick after a safety may be a punt, drop kick or place kick.

Kickoff

ARTICLE 6. A kickoff is a free kick that starts each half and follows each try or successful field goal attempt (**Exception:** In extra periods). It must be a place kick or a drop kick.

Approved Ruling 2-16-6

- l. After a touchdown and successful 2-point try, Team A trails 24-22 with 0:55 left in the 4th quarter. Team A intends to try an onside free kick from the A-35. Kicker A90 holds the ball as if they will attempt a drop kick. A90 then tosses the ball up in the air and the ball bounces just behind Team A's restraining line and then A90 kicks the ball after it bounces several feet into the air. **RULING:** Illegal Kick. Dead-ball foul. Penalty - Five yards from the succeeding spot. This kick does not meet the requirements of a drop kick as required in Rule 2-16-3. For a legal drop kick the kicker must drop the ball and kick it as it touches the ground. Since Rule 2-16-6 only allows a place kick or a drop kick for a kickoff, this kick is not a legal kick. The penalty enforcement follows the current Approved Ruling 6-1-2:l. [Cited by 6-1-2-a]

Scrimmage Kick

- ARTICLE 7. a. A scrimmage kick is a punt, drop kick or field goal place kick. It is a legal kick if it is made by Team A in or behind the neutral zone during a scrimmage down before team possession changes.
- b. A scrimmage kick has crossed the neutral zone when it touches the ground, a player, an official or anything beyond the neutral zone (**Exception:** Rule 6-3-1-b). (**A.R. 6-3-1:I-IV**)
- c. A scrimmage kick made when a ball carrier's entire body and the ball is or has been beyond the neutral zone is an illegal kick and a live-ball foul that causes the ball to become dead (Rule 6-3-10-c).

Return Kick

ARTICLE 8. A return kick is a kick by a player of the team in possession after change of team possession during a down. It is an illegal kick and a live-ball foul that causes the ball to become dead (Rule 6-3-10-b).

Field Goal Attempt

ARTICLE 9. A field goal attempt is a scrimmage kick. It may be a place kick or a drop kick.

Scrimmage Kick Formation

ARTICLE 10.

- a. A scrimmage kick formation is a formation with **no player other than the potential kicker (or holder) aligned within the frame of the body of the snapper and no player aligned in the clear path from the snapper to the potential kicker (or holder), and with either (1) at least one potential kicker seven or more yards behind the neutral zone; or (2) a potential holder and potential kicker five or more yards behind the neutral zone in position for a place kick. For either (1) or (2) to qualify as a scrimmage kick formation, it must be obvious that a kick will be attempted (A.R. 7-1-4:VIII) (A.R. 9-1-14:I-III).**

- b. If Team A is in a scrimmage kick formation at the snap, any action by Team A during the down is deemed to be from a scrimmage kick formation.

Approved Ruling 2-16-10

- l. At the snap Team A has four linemen numbered between 50-79 and three linemen numbered outside this range. A potential kicker is six yards deep but there is no potential holder. **RULING:** Illegal formation. Team A is not in a scrimmage kick formation and does not have the required number of linemen with proper jersey numbers.

SECTION 17. The Neutral Zone

- ARTICLE 1. a. The neutral zone is the space between the two scrimmage lines extended to the sidelines (Rule 2-21-2). Its width is equal to the length of the ball.
- b. The neutral zone is established when the ball is ready for play and is resting on the ground with its long axis at right angles to the scrimmage line and parallel to the sidelines.
- c. The neutral zone exists until there is a change of team possession, until a scrimmage kick crosses the neutral zone, or until the ball is declared dead.

SECTION 18. Encroachment and Offside

Encroachment

ARTICLE 1. After the ball is ready for play, encroachment occurs when an offensive player is in or beyond the neutral zone after the snapper touches or simulates (hand(s) at or below their knees) touching the ball before the snap. (*Exception:* When the ball is put in play, the snapper is not encroaching when they are in the neutral zone.)

Offside on a scrimmage play

ARTICLE 2. After the ball is ready for play, offside occurs (Rule 7-1-5) when a defensive player:

- a. Is in or beyond the neutral zone when the ball is legally snapped; or
- b. Contacts an opponent beyond the neutral zone before the ball is snapped; or
- c. Contacts the ball before it is snapped; or
- d. Threatens an offensive lineman, causing an immediate reaction, before the ball is snapped (Rule 7-1-2-b-3-Exception, (A.R. 7-1-3:V Note)); or
- e. Crosses the neutral zone and charges toward a Team A back (A.R. 7-1-5:III).

Offside on a free kick play

ARTICLE 3. Offside occurs (Rule 6-1-2) when:

- a. A defensive player is not behind their restraining line when the ball is legally free-kicked.
- b. One or more players of the kicking team are not behind their restraining line when the ball is legally free-kicked (*Exception:* The kicker and holder are not offside when they are beyond their restraining line.)

SECTION 19. Passes

Passing

ARTICLE 1. Passing the ball is throwing it. A pass continues to be a pass until it is caught, recovered or intercepted by a player or the ball becomes dead.

Forward and Backward Pass

- ARTICLE 2. a. A pass is forward if the ball first strikes the ground, a player, an official or anything else beyond the spot where the ball is released. All other passes are backward passes. When in question, a pass thrown in or behind the neutral zone is a forward rather than a backward pass.
- b. When a Team A player is holding the ball to pass it forward toward the neutral zone, any intentional forward movement of their hand with the ball firmly in their control starts the forward pass unless the player clearly starts to bring the ball back with firm control to their body. If a Team B player contacts the forward passer or ball after forward movement begins and the ball leaves the forward passer's hand, a forward pass is ruled regardless of where the ball strikes the ground or a player. **(A.R. 2-19-2:I)**
- c. When in question, the ball is passed forward and not fumbled during an attempted forward pass.
- d. A snap becomes a backward pass when the snapper releases the ball, other than via a hand-to-hand exchange **(A.R. 2-23-1:I)**.

Approved Ruling 2-19-2

- i. A1 intends to throw a forward pass, but B1 bats the ball from their hand before A1's hand starts forward.
RULING: Fumble (Rule 2-11-1). [Cited by 2-11-1, 2-19-2-b]

Crosses Neutral Zone

- ARTICLE 3. a. A legal forward pass has crossed the neutral zone when it first strikes the ground, a player, an official or anything beyond the neutral zone inbounds. It has not crossed the neutral zone when it first strikes the ground, a player, an official or anything in or behind the neutral zone inbounds.
- b. A player has crossed the neutral zone if their entire body has been beyond the neutral zone.
- c. A legal forward pass is beyond or behind the neutral zone where it crosses the sideline.

Approved Ruling 2-19-3

- i. QB A12 throws a legal forward pass, and receiver A88 first touches the pass when the ball is 1½ yards beyond the neutral zone. The receiver's back foot is not beyond the neutral zone. **RULING:** The legal forward pass has crossed the neutral zone. Rule 2-19-3-a states that a pass has crossed the neutral zone when it strikes anything beyond the neutral zone. By Rule 2-19-3-b, A88 as a player is not beyond the neutral zone. Nevertheless, by Rule 2-19-3-a the pass has crossed the neutral zone since it was beyond the neutral zone when A88 touched it. The guiding principle on a pass crossing the neutral zone is the location of the ball when it is first touched.

Catchable Forward Pass

ARTICLE 4. A catchable forward pass is an untouched legal forward pass beyond the neutral zone to an eligible player who has a reasonable opportunity to catch the ball. When in question, a legal forward pass is catchable.

SECTION 20. Penalty

A penalty is a result imposed by rule against a team that has committed a foul and may include one or more of the following: loss of yardage, loss of down, automatic first down, disqualification or subtraction from the game clock (Rule 10-1-1-b).

SECTION 21. Scrimmage

Scrimmage Down

ARTICLE 1. A scrimmage down is the action between the two teams during a down that begins with a legal snap.

NOTE: A try down is a scrimmage down that begins when the referee declares the ball ready for play (Rule 8-3-2-b).

Scrimmage Line

ARTICLE 2. The scrimmage line for each team is established when the ball is ready for play. It is the yard line that defines the vertical plane passing through the point of the ball nearest a team's own goal line.

SECTION 22. Shift

- ARTICLE 1. a. A shift is a simultaneous change of position or stance by two or more offensive players after the ball is ready for play before the snap for a scrimmage down. (A.R. 7-1-3:I-II) (A.R. 7-1-2:I-IV)
- b. The shift ends when all players have been motionless for one full second.
- c. The shift continues if one or more players are in motion before the end of the one second interval.

SECTION 23. Snapping the Ball

- ARTICLE 1. a. Legally snapping the ball (a snap) is handing or passing it backward from its position on the ground with a quick and continuous motion of the hand or hands, the ball actually leaving the hand or hands in this motion (Rule 4-1-4).
- b. The snap starts when the ball is moved legally and ends when the ball leaves the snapper's hands; the ball then becomes alive (Rule 4-1-1) (A.R. 2-23-1:I-II) (A.R. 7-1-5:I-II).
- c. If, during any backward motion of a legal snap, the ball slips from the snapper's hand, it becomes a backward pass and is in play (Rule 4-1-1).
- d. While resting on the ground and before the snap, the long axis of the ball must be at right angles to the scrimmage line (Rule 7-1-3).
- e. Unless moved in a backward direction, the movement of the ball does not start a legal snap. It is not a legal snap if the ball is first moved forward or lifted.
- f. If the ball is touched by Team B during a legal snap, the ball remains dead and Team B is penalised. If the ball is touched by Team B during an illegal snap, the ball remains dead and Team A is penalised. (A.R. 7-1-5:I-II)
- g. The snap need not be between the snapper's legs; but to be legal, it must be a quick and continuous backward motion.
- h. The ball must be snapped on or between the hash marks.

Approved Ruling 2-23-1

- I. Fourth and goal on Team B's five-yard line. A55's legal snap is muffed by A12 and (a) any player of Team A recovers and advances the ball into the end zone, or (b) a player of Team B recovers and advances the ball. **RULING:** The snap is a backward pass and may be advanced by any player. (a) Touchdown. Since this is a backward pass and not a fumble there is no restriction on a Team A player recovering and advancing the ball. (b) Ball continues in play. [Cited by 2-19-2-d, 2-23-1-b, 7-2-2-a, 8-2-1-a]
- II. 3/5 @ B-25. QB A12 is in shotgun formation. Center A57 legally starts the backward motion of the snap with a quick and continuous motion. During this backward motion (a) the ball slips from the snapper's hands and is loose at the B-29 and B54 recovers the ball, or (b) the snapper clutches or pauses before releasing the ball and the ball subsequently slips from the snapper's hands and is loose at the B-29 and B54 recovers the ball. **RULING:** (a) Legal snap that becomes a backward pass. Team B's ball, 1/10 @ B-29. (b) Team A dead-ball foul, illegal snap. Team A's ball, 3/10 @ B-30. To be a legal snap, the ball must be handed or passed backward from its position on the ground with a quick and continuous motion and the ball leaving the snapper's hands in this motion. If the ball, during the backward motion of a legal snap, slips from the snapper's hand, it becomes a backward pass, and the ball is in play. Any other action or motion by the snapper such as not releasing the ball, pausing, restarting, or breaking the continuous motion of the ball during the snap is considered an illegal snap. [Cited by 2-23-1-b]

SECTION 24. Series and Possession Series

Series

ARTICLE 1. A series comprises up to four consecutive downs that each begins with a snap (Rule 5-1-1).

Possession Series

ARTICLE 2. A possession series is a team's continuous possession of the ball in an extra period (Rule 3-1-3). It may consist of one or more series.

SECTION 25. Spots

Enforcement Spot

ARTICLE 1. An enforcement spot is the point at which the penalty for a foul or the result of a violation is enforced.

Previous Spot

ARTICLE 2. The previous spot is the point at which the ball was last put in play.

Succeeding Spot

ARTICLE 3. The succeeding spot is the point at which the ball is next to be put in play.

Dead-Ball Spot

ARTICLE 4. The dead-ball spot is the point at which the ball became dead.

Spot of the Foul

ARTICLE 5. The spot of the foul is the point at which that foul occurs. If out of bounds between the goal lines, it shall be the intersection of the nearer hash mark and the yard line extended through the spot of the foul. If out of bounds between the goal line and the end line or behind the end line, the foul is in the end zone.

Out-of-Bounds Spot

ARTICLE 6. The out-of-bounds spot is the point at which the ball becomes dead by rule because of going or being declared out of bounds.

Inbounds Spot

ARTICLE 7. The inbounds spot is the intersection of the nearer hash mark line and the yard line passing through either the dead-ball spot or the spot where a penalty leaves the ball in a side zone.

Spot Where Run Ends

ARTICLE 8. The spot where the run ends is the point:

- a. Where the ball is declared dead in player possession.
- b. Where player possession is lost on a fumble.
- c. Where handing of the ball occurs.
- d. Where an illegal forward pass is thrown.
- e. Where a backward pass is thrown.
- f. Where an illegal scrimmage kick is made beyond the line of scrimmage.
- g. Where a return kick occurs.

- h. Where player possession is gained under provisions of the "momentum rule" (Rule 8-5-1-a Exceptions).

Spot Where Kick Ends

ARTICLE 9. A scrimmage kick that crosses the neutral zone ends at the spot where it is caught or recovered or where the ball is declared dead by rule (Rule 2-16-1-c). (*Exception:* If inadvertent whistle provisions apply, the end of a kick is where the ball next touches a player, official, the ground or crosses a boundary line after the whistle has blown.)

Basic Spot

ARTICLE 10. The basic spot is a benchmark for locating the enforcement spot for penalties governed by the Three-and-One Principle (Rule 2-33). Basic spots for the various categories of plays are given in Rule 10-2-2-d.

Postscrimmage Kick Spot

ARTICLE 11. The postscrimmage kick spot serves as the basic spot when postscrimmage kick enforcement applies (Rule 10-2-3).

- a. When the kick ends in the field of play, other than in the special cases given below, the postscrimmage kick spot is the spot where the kick ends.
- b. When the kick ends in Team B's end zone, the postscrimmage kick spot is Team B's 20-yard line.
- c. When the kick ends in Team A's end zone, the postscrimmage kick spot is Team A's goal line.

Special cases:

1. On an unsuccessful field goal attempt, if the ball is untouched by Team B after crossing the neutral zone and is declared dead beyond the neutral zone, the postscrimmage kick spot is:
 - (a) The previous spot, if the previous spot is on or outside Team B's 20-yard line;
(A.R. 10-2-3:V)
 - (b) Team B's 20-yard line, if the previous spot is between Team B's 20-yard line and its goal line.
2. When Rule 6-3-11 is in effect, the postscrimmage kick spot is Team B's 20-yard line.
3. When Rule 6-5-1-b is in effect, the postscrimmage kick spot is the spot where the receiver first touched the kick.

SECTION 26. Tackling

Tackling is grasping or encircling an opponent with a hand(s) or arm(s).

SECTION 27. Team and Player Designations

Teams A and B

ARTICLE 1. Team A is the team that is designated to put the ball in play, and Team B is the opponent. The teams retain these designations until the ball is next ready for play.

Offensive and Defensive Teams

ARTICLE 2. The offensive team is the team in possession, or the team to which the ball belongs; the defensive team is the opposing team.

Kicker and Holder

ARTICLE 3. a. The kicker is any player who punts, drop kicks or place kicks according to rule. They remain the kicker until they have had a reasonable time to regain their balance.

- b. A holder is a player who controls the ball on the ground or on a kicking tee. During a scrimmage-kick play, they remain the holder until no player is in position to make the kick or, if the ball is kicked, until the kicker has had a reasonable time to regain their balance.

Lineman and Back

ARTICLE 4. a. *Lineman*.

1. A lineman is any Team A player legally on their scrimmage line (Rule 2-21-2).
 2. A Team A player is legally on the scrimmage line when facing their opponent's goal line with the line of their shoulders approximately parallel thereto and either (a) they are the snapper (Rule 2-27-8) or (b) their head breaks the plane of the line drawn through the waistline of the snapper.
- b. *Interior lineman*. An interior lineman is a lineman who is not on the end of their scrimmage line.
- c. *Restricted lineman*. A restricted lineman is any interior lineman, or any lineman wearing a number 50-79, whose hand(s) are below the knees.
- d. *Back*.
1. A back is any Team A player who is not a lineman and whose head or shoulder does not break the plane of the line drawn through the waistline of the nearest Team A lineman.
 2. A back is also the player in position to receive a hand-to-hand snap.
 3. A lineman becomes a back before the snap when they move to a position as a back and stop.

Forward passer

ARTICLE 5. The forward passer is the player who throws a forward pass. That player is a forward passer from the time the ball is released until the pass is complete, incomplete or intercepted, or until they move to participate in the play.

Player

- ARTICLE 6. a. A player is any one of the participants in the game who is not a substitute or a replaced player and is subject to the rules when inbounds or out of bounds.
- b. An airborne player is a player not in contact with the ground because they have leapt, jumped, dived, launched, or been contacted by an opponent or teammate, etc. in other than normal running action.
- c. A departing player is a player leaving the field, having been replaced by a substitute.
- d. A teammate is a player of the same team.

Runner and Ball Carrier

- ARTICLE 7. a. The runner is a player in possession of a live ball or simulating possession of a live ball.
- b. A ball carrier is a runner in possession of a live ball.

Snapper

ARTICLE 8. The snapper is the player who snaps the ball. That player is established as the snapper when they take a position behind the ball and touch or simulate (hand(s) at or below their knees) touching the ball (Rule 7-1-3).

Substitute

- ARTICLE 9. a. A legal substitute is a replacement for a player or a player vacancy during the interval between downs.
- b. A legal incoming substitute becomes a player when they enter the field of play or end zones and communicate with a teammate or an official, enter the huddle, are positioned in an offensive or defensive formation, or participate in a play (**A.R. 3-5-2:VI**).

Replaced Player

ARTICLE 10. A replaced player is one who participated during the previous down, has been replaced by a substitute and has left the field of play and the end zones.

Player Vacancy

ARTICLE 11. A player vacancy occurs when a team has fewer than 11 players in the game.

Disqualified Player

- ARTICLE 12. a. A disqualified player is one who is declared ineligible for further participation in the game.
- b. A disqualified player or coach must leave the playing enclosure under the escort of team personnel before the next play after their disqualification. They must remain out of view of the field of play under team supervision for the duration of the game.

Squad Member

ARTICLE 13. A squad member is part of a group of potential players, in uniform, organised for participation in the ensuing football game or football plays.

Defenseless player

ARTICLE 14. A defenseless player is one who because of their physical position and focus of concentration is especially vulnerable to injury. When in question, a player is defenseless. Examples of defenseless players include but are not limited to:

- a. A player in the act of or just after throwing a pass. This includes an offensive player in a passing posture with focus downfield.
- b. A receiver attempting to catch a forward pass or in position to receive a backward pass, or one who has completed a catch and has not had time to protect themselves or has not clearly become a ball carrier.
- c. A kicker in the act of or just after kicking a ball, or during the kick or the return.
- d. A kick returner attempting to catch or recover a kick, or one who has completed a catch or recovery and has not had time to protect themselves or has not clearly become a ball carrier.
- e. A player on the ground.
- f. A player obviously out of the play.
- g. A player who receives a blind-side block.
- h. A ball carrier already in the grasp of an opponent and whose forward progress has been stopped.
- i. A quarterback any time after a change of possession.
- j. A ball carrier who has obviously given themselves up and is sliding feet-first.
- k. A player attempting to catch or recover a [loose ball](#).
- l. A snapper protected by Rule 9-1-14.

Player Out of Bounds and In Bounds

ARTICLE 15. a. *Out of Bounds*

1. A player is out of bounds when any part of their body touches anything other than another player or a game official on or outside a boundary line.
 2. An out-of-bounds player who becomes airborne remains out of bounds until they touch the ground in bounds without simultaneously being out of bounds.
- b. *In Bounds*
1. An inbounds player is a player who is not out of bounds.

2. An inbounds player who becomes airborne remains in bounds until they are out of bounds.

Coach

- ARTICLE 16. a. A coach is a person subject to the rules who, while in the team area, coaching box, press box (or another authorised place within the playing enclosure), observes the game and/or gives instructions to players and substitutes.
- b. A player/coach is regarded as being a coach when in the team area or coaching box and as a player or substitute otherwise.
 - c. Each team shall designate a coach as its head coach, and identify them on the roster form and to the referee. A head coach disqualified from the game may designate a new head coach (Rule 9-2-6-d).

SECTION 28. Tripping

Tripping is intentionally using the lower leg or foot to obstruct an opponent below the knees (Rule 9-1-2-c).

SECTION 29. Timing Devices

Game Clock

ARTICLE 1. The game clock is any device under the direction of the appropriate official used to time the duration of the game.

Play Clock

- ARTICLE 2. a. Each stadium should have a visual play clock at each end of the playing enclosure. The play clock (if provided) must be capable of counting down from both 40 seconds and 25 seconds. It should automatically default to 40 seconds and start immediately upon being reset by the play-clock operator. The play clock operator will consistently start the 40-second play clock within one second of any official signalling that the ball is dead after a play.
- b. Otherwise, the play clock is any device under the direction of the appropriate official used to time the 40/25 seconds between the end of the previous play or the ready for play signal and the ball being put in play.

SECTION 30. Play Classification

Forward Pass Play

ARTICLE 1. A legal forward pass play is the interval between the snap and when a legal forward pass is complete, incomplete or intercepted.

Free Kick Play

ARTICLE 2. A free kick play is the action during the interval from the time the ball is legally kicked until it comes into player possession or is declared dead by rule.

Scrimmage Kick Play

ARTICLE 3. A scrimmage kick play is the action during the interval between the snap and when a scrimmage kick comes into player possession or the ball is declared dead by rule.

Running Play and Run

- ARTICLE 4. a. A running play is any live-ball action other than that during a free kick play, a scrimmage kick play, or a legal forward pass play.
- b. A run is that segment of a running play during which a ball carrier has possession.
- c. If a ball carrier loses possession by a fumble, backward pass, or illegal forward pass, the spot where the run ends (Rule 2-25-8) is the yard line where the ball carrier loses possession. The running play includes the run and the loose-ball action before a player gains or regains possession or the ball is declared dead. **(A.R. 2-30-4:I and II)**
- d. A new running play begins when a player gains or regains possession.

Approved Ruling 2-30-4

- I. A21 catches a forward pass with their knees on the ground. The forward passer is roughed during the pass. **RULING:** A21's catch started a running play, which ended immediately. Penalise 15 yards from the end of the run, first down for Team A. [Cited by 2-30-4-c]
- II. Third and 10. A21 catches a forward pass and fumbles when tackled after gaining nine yards. The fumble is recovered by grounded A24 five yards in advance of the fumble. During the pass, the forward passer is roughed. **RULING:** Penalise 15 yards from the spot of recovery by A24 (end of last run), first down for Team A. [Cited by 2-30-4-c]

Result of the Play

ARTICLE 5. The result of the play is the game situation when the ball becomes dead and before the enforcement of penalties for any fouls or violations occurring during the play.

SECTION 31. Field Areas

The Field

ARTICLE 1. The field is the area within the limit lines and includes the limit lines and team areas and the space above it (**Exception:** Enclosures over the field).

Field of Play

ARTICLE 2. The field of play is the area enclosed by the sidelines and the goal lines.

End Zones

- ARTICLE 3. a. The end zone at each end of the field is the rectangle defined by the goal line, sidelines and end line.
- b. The goal line and goal line pylons are in the end zone.
- c. A team's end zone is the one it is defending. **(A.R. 8-5-1:VII) (A.R. 8-6-1:I)**

Playing Surface

ARTICLE 4. The playing surface is the material or substance within the field of play, including the end zones.

Playing Enclosure

ARTICLE 5. The playing enclosure is that area bounded by the stadium, dome, stands, fences or other structures (**Exception:** Scoreboards are not considered within the playing enclosure). Where there is no stadium, dome or stands, the playing enclosure is any area within sight and/or sound of the field (Rules 9-2-6-b and 9-2-7).

Side Zone

ARTICLE 6. The side zone is the area between the hash marks and the near sideline.

SECTION 32. Fighting

ARTICLE 1. Fighting is any attempt by a player, coach or squad member in uniform to strike an opponent in a combative manner unrelated to football. Such acts include, but are not limited to:

- a. An attempt to strike an opponent with the arm(s), hand(s), leg(s) or foot (feet), whether or not there is contact.
- b. An unsportsmanlike act toward an opponent that causes any opponent to retaliate by fighting (Rules 9-2-1 and 9-5-1).

SECTION 33. Three-and-One Principle

The Three-and-One Principle of penalty enforcement applies when the penalty statement for a foul does not specify the enforcement spot. Application of this principle is described in Rule 10-2-2-c.

SECTION 34. Tackle Box

- ARTICLE 1. a. The tackle box is the rectangular area enclosed by the neutral zone, the two lines parallel to the sidelines five yards from the snapper and Team A's end line. (See Appendix D.)
- b. The tackle box disintegrates when the ball leaves it.

SECTION 35. Targeting

ARTICLE 1. "Targeting" means that a player takes aim at an opponent for purposes of attacking with forcible contact that goes beyond making a legal tackle or a legal block or playing the ball. Some indicators of targeting include but are not limited to:

- a. Launch — a player leaving their feet to attack an opponent by an upward and forward thrust of the body to make forcible contact in the head or neck area.
- b. A crouch followed by an upward and forward thrust to attack with forcible contact at the head or neck area, even though one or both feet are still on the ground.
- c. Leading with helmet, shoulder, forearm, fist, hand or elbow to attack with forcible contact at the head or neck area.
- d. Lowering the head before attacking by initiating forcible contact with the crown of the helmet.

RULE 3

Periods, Time Factors and Substitutions

SECTION 1. Start of Each Period

Pregame, First and Third Periods

- ARTICLE 1. a. Prior to the game, during warm-ups, teams must remain in an agreed separate half of the field, normally the half up to the line five yards from midfield to their left, looking from their team area towards the field (Appendix D).
- b. When any squad member enters the playing enclosure prior to the officials escorting the captains out for the coin toss, the head coach or an assistant coach from that team must be present on the field.
- c. When squad members are present within the playing enclosure subsequent to the officials' jurisdiction, they must be wearing their jerseys or have their numerals readily visible. Any player without their numeral readily visible must leave the playing enclosure (**A.R. 3-1-1:I**).
- d. Each half shall start with a kickoff.
- e. Three minutes before the scheduled starting time, the referee shall toss a coin at midfield in the presence of not more than four field captains from each team and another game official, first designating the field captain of the visiting team to call the coin toss. Before the second half, the referee will obtain the teams' second half options.
- f. During the coin toss, each team shall remain in its team area. The coin toss begins when the field captains leave the sidelines and ends when the captains return to the sidelines.

PENALTY – [f] Five yards from the succeeding spot [S19: IPR].

- g. The winner of the toss shall choose one of the following options:
1. To designate which team shall kick off.
 2. To designate which goal line their team shall defend. (**Exception:** This option is not available if only one goal is being used (Rule 1-2-5-f).)
 3. To defer their selection to the second half.
- h. The opponent shall then choose option 1 or 2 above, as available.
- i. If the winner of the toss chooses option 3 above, then after the opponent's choice the winner selects the available option (1 or 2 above).
- j. For the second half, the loser of the toss, or the winner who chooses option 3 above, shall choose option 1 or 2 above. The opponent then chooses the remaining available option.

Approved Ruling 3-1-1

- l. After the officials' jurisdiction has begun, a few home team players enter the playing enclosure without their game jersey, and do not have their numeral readily visible. **RULING:** The players with no game jersey or numeral readily visible must immediately leave the playing enclosure. The head coach or assistant coach(es) on the field may help with this situation. [Cited by 3-1-1-c]

Second and Fourth Periods

ARTICLE 2. Between the first and second periods and also between the third and fourth periods, the teams shall defend opposite goal lines (**Exception:** Rule 1-2-5-f-2-d).

- a. The ball shall be relocated at the spot corresponding exactly, in relation to goal lines and sidelines, to its location at the end of the preceding period.

- b. Possession of the ball, the number of the down and the distance to be gained shall remain unchanged.

Extra Periods

ARTICLE 3. The tiebreaker system will be used when a game is tied after four periods. (*Exception:* ▽ Competitions may adopt regulations to forgo the tiebreaker system if the scores are tied at the end of a regular season game. In that event, the game shall be terminated and the result shall stand as a tie.) IFAF football-playing rules apply, with the following exceptions:

- a. Immediately after the conclusion of the fourth quarter, officials will instruct both teams to retire to their respective team areas. The officials will assemble at the midfield line and review the tiebreaker procedures.
- b. The officials will escort the captains (Rule 3-1-1) to the centre of the field for the coin toss. The referee shall toss a coin at midfield in the presence of not more than four field captains from each team and another game official, first designating the field captain of the visiting team to call the coin toss. The winner of the toss may not defer the choice and must choose one of the following options:
1. Offense or defense, with the offense at the opponent's 25-yard line to start the first possession series.
 2. Which end of the field shall be used for both possession series of that overtime period.
- c. The loser of the toss shall exercise the remaining option for the first extra period and shall have the first choice of the two options for subsequent even-numbered extra periods.
- d. *Definition.* An extra period shall consist of two possession series with each team putting the ball in play by a snap on or between the hash marks on the designated 25-yard line (unless relocated by penalty); this becomes the opponent's 25-yard line. The snap shall be from midway between the hash marks, unless the offensive team selects a different position on or between the hash marks before the ready-for-play signal. After the ready-for-play signal, the ball may be relocated only after a charged team timeout, unless preceded by a Team A foul or offsetting fouls.
- e. *Possession series.* Each team retains the ball during a possession series until it scores or fails to make a first down. The ball remains alive after a change of team possession until it is declared dead. However, Team A may not have a first down if it regains possession after a change of team possession (**A.R. 3-1-3:I-IX**). Beginning with the third extra period, a team's possession series will be one play for a two-point try from the three-yard line, unless relocated by penalty. Team A and B designations are the same as defined in Rule 2-27-1.
- f. *Scoring.* The team scoring the greater number of points during the regulation and extra periods shall be declared the winner. There shall be an equal number of possession series, as described in (e) above, in each extra period, unless Team B scores other than on the try. Beginning with the second extra period, teams scoring a touchdown must attempt a two-point try. Although not illegal, a one-point try attempt by Team A will not result in a score (**A.R. 3-1-3:X, XV**).
- g. Fouls after a change of team possession are treated specially (Rule 10-2-7). (**A.R. 3-1-3:XI-XIV**)
- h. *Timeouts.* Each team shall be allowed one timeout for the first extra period and one timeout for the second extra period. Each team will be allowed one timeout beginning with the third extra period until the game is ended (Rule 3-3-8). Timeouts not used during the regulation periods may not be carried over into the extra period(s). Unused extra period timeouts may not be carried over to other extra periods. Timeouts between periods shall be charged to the succeeding period. Radio and television timeouts are permitted only after the first and second extra periods. Charged team timeouts may not be extended for radio and television purposes. The extra period(s) begins when the ball is first snapped.

In the absence of a media timeout, after the second^x extra period, there will be a two-minute mandatory break period.

Approved Ruling 3-1-3

- I. Other than on the try, Team B scores a touchdown after intercepting a forward pass, intercepting or recovering a backward pass or fumble, or returning a blocked field goal attempt. **RULING:** Period and game are ended, and Team B is the winner. [Cited by 3-1-3-e]
- II. During the first possession series of a period, Team B intercepts a forward pass, or intercepts or recovers a fumble or a backward pass, and does not score a touchdown. **RULING:** Team A's possession series is ended and Team B starts its series. Team B becomes Team A when the referee declares the ball ready for play. [Cited by 3-1-3-e]
- III. During the first possession series of a period, Team A's field goal attempt is blocked and does not cross the neutral zone. Team A recovers the ball and runs for a touchdown. **RULING:** Six points for Team A. Team B begins its possession series after the try. [Cited by 3-1-3-e]
- IV. Team A's field goal attempt is blocked and does not cross the neutral zone. A23 recovers the ball and is tackled beyond the line to gain. **RULING:** Team A retains the ball to continue its possession series. First and 10. [Cited by 3-1-3-e]
- V. On first, second or third down, Team A's field goal attempt is blocked and does not cross the neutral zone. A23 recovers the ball and is tackled short of the line to gain. **RULING:** Team A's ball, next down. [Cited by 3-1-3-e]
- VI. During the first possession series of a period, Team B gains possession and then loses possession to Team A, which (a) scores a touchdown; (b) does not score a touchdown. **RULING:** (a) The score counts. In both (a) and (b), Team A's possession series ends and Team B begins its possession series. [Cited by 3-1-3-e]
- VII. During the first possession series of a period, Team A fumbles into Team B's end zone on second down of a series. Team B recovers and downs the ball in its end zone. **RULING:** Team A's possession series is ended. Team B begins its possession series. [Cited by 3-1-3-e]
- VIII. During the first possession series of a period, B10 intercepts a forward pass on their six-yard line and downs the ball in their end zone. **RULING:** Safety: two points for Team A. Team A's possession series is over. Team B will put the ball in play, first and 10 on the 25-yard line at the same end of the field. [Cited by 3-1-3-e]
- IX. Team A's field-goal attempt is untouched beyond the neutral zone until B17 muffs it at the five-yard line. A75 recovers at the three-yard line. **RULING:** Team A's possession series continues; first down for Team A at the three-yard line. [Cited by 3-1-3-e]
- X. On the first possession series of a period, Team A scores a touchdown. On the try, Team B intercepts a pass and returns it for a two-point touchdown. **RULING:** Team B starts its possession series at the 25-yard line with Team A leading in the overtime score 6-2. [Cited by 3-1-3-f]
- XI. After the end of the first possession series by Team A, Team B commits a dead-ball personal foul. **RULING:** Team B starts its possession series on the 40-yard line, first and 10. [Cited by 3-1-3-g]
- XII. During the first possession series of a period, A12 throws a forward pass and Team A is flagged for an illegal shift. B25 intercepts the pass, and B38 (a) clips or (b) commits a flagrant personal foul before B25 crosses Team A's goal line. **RULING:** Score not allowed. The fouls cancel and the down is not repeated. Team A's possession series is ended, and Team B begins its possession series at the 40-yard line. In (b), B38 is disqualified. [Cited by 3-1-3-g]
- XIII. During the second possession series of the first period, B25 intercepts a pass and carries the ball across Team A's goal line. During the run, B79 clips at midfield. **RULING:** No touchdown. Either the game is over, or the next period will start with first and 10 at either the 12½ or 40-yard lines as the penalty carries over. [Cited by 3-1-3-g]
- XIV. During the first possession series B37 intercepts a forward pass and has a clear field to the goal line when they make an obscene gesture toward the nearest opponent. **RULING:** Team B's score is cancelled and the penalty is carried over. Team B begins its possession series on the 40-yard line, first and 10. (Rules 3-1-3, 10-2-7-a and 10-2-7-b). [Cited by 3-1-3-g]
- XV. In the third or subsequent extra period, Team B intercepts a pass and returns it for a 2-point touchdown. **RULING:** The game is over. Team B has won. There is no need for Team B to have its possession series (Rule 3-1-3-f). [Cited by 3-1-3-f]

SECTION 2. Playing Time and Intermissions

Length of Periods and Intermissions

ARTICLE 1. The normal total playing time in a game shall be 48 minutes, divided into four periods of 12 minutes each, with one-minute intermissions between the first and second periods (first half) and between the third and fourth periods (second half) (*Exception:* A one-minute intermission between the first and second and the third and fourth periods may be extended for radio and television timeouts).

∇ Competitions or national federations may adopt regulations to set the maximum playing time in a game to 60, 48, 40 or 32 minutes, provided the four periods are of equal length.

- a. No period shall end until the ball is dead and the referee declares the period ended [S14].
- b. ∅ The intermission between halves shall be 20 minutes, unless altered before the game by mutual agreement of the administrations of both teams and the competition authority. Immediately after the second period ends, the referee should begin the intermission by signalling to start the game clock [S2].
- c. At the end of the first half, after the teams have left the field and the referee has: (1) cleared the final play with the on-field crew; (2) cleared the final play with the video judge (if present); and (3) there is no head coach video review challenge, the referee will declare the first half ended. After the referee declares the first half ended, there shall be no additional replay reviews from the previous play.
- d. § Game management will determine the timing of halftime activities. The field will be available to squad members no later than three minutes prior to the second half kickoff. When any squad member enters the playing enclosure during the halftime intermission, a staff member from that team must be present on the field. If kickers or other squad members come onto the playing enclosure before the field is available, their activities must be confined to the team area.
- e. § It is strongly recommended that game management schedule the kickoff time no later than four hours before darkness (defined as the time of local sunset or the time at which any artificial lights must be switched off).
- f. # If a game (delayed by five or more minutes) kicks off less than 3½ hours before darkness, playing time shall be limited to a maximum of 48 minutes.
- g. # If a game (delayed by five or more minutes) kicks off less than 3 hours before darkness, playing time shall be limited to a maximum of 40 minutes. (A.R. 3-2-1:I)

Approved Ruling 3-2-1

- l. A game is scheduled with a kickoff time 3 hours before darkness. (a) It kicks off on schedule. (b) The kickoff is delayed by 5 or more minutes. **RULING:** (a) The playing time will be as determined by the competition (48 minutes by default). (b) The playing time will be limited to a maximum of 40 minutes. [Cited by 3-2-1-g]

Timing Adjustments

ARTICLE 2. Before the game starts, playing time and the intermission between halves may be shortened by the referee if they are of the opinion that darkness or other conditions may interfere with the game. The four periods must be of equal length if the game is shortened before its start.

- a. ∅ Any time during the game, the playing time of any remaining period or periods and the intermission between halves may be shortened by mutual agreement of the opposing head coaches and the referee. (A.R. 3-2-2:I)
- b. Timing errors on the game clock may be corrected but only in the period in which they occur.
- c. If the referee has positive knowledge of the elapsed time, they will reset and appropriately start the game clock.
- d. Timing errors on a play clock may be corrected by the referee. The play clock shall start again (Rule 2-29-2).

- e. When the play clock count is interrupted by circumstances beyond the control of either team (without positive knowledge of game clock elapsed time), a new count shall be started and the game clock shall start per Rule 3-2-4-b.
- f. The 40/25-second play clock is started even if the game clock is running with fewer than 40 or 25 seconds, respectively, in a period.
- g. The game clock should not be stopped if the play clock **is/is not** started in conflict with paragraph f above.
- h. Timing adjustments for games using video review are governed by Rule 12-1-2-a-12.

Approved Ruling 3-2-2

- i. At halftime the score is 56-0. The head coaches and the referee agree that the third and fourth quarters should be shortened to 10 minutes each. The coaches also request that the second half be played with a "running clock," i.e., that the game clock not be stopped. **RULING:** The remaining quarters may be shortened to 10 minutes each. Whether a "running clock" is implemented or not depends on Competition Regulations relating to Rule 3-3-2. If Rule 3-3-2 is not in effect, normal clock rules apply for the entire game. [Cited by 3-2-2-a]

Extension of Periods

- ARTICLE 3. a. A period shall be extended for an untimed down if one or more of the following occurs during a down in which time expires in the 2nd or 4th quarter (provided it is not during a running clock session) (**A.R. 3-2-3:I-VIII**):
1. A penalty is accepted for a live-ball foul (**Exception:** Rules 10-2-5-a and 10-2-5-d). At the option of the offended team, the period is *not* extended if the foul is by the team in possession and the statement of the penalty includes loss of down (**A.R. 3-2-3:VIII**).
 2. At the option of the offended team, an illegal touching violation is accepted.
 3. There are offsetting fouls.
 4. An official sounds their whistle inadvertently or otherwise incorrectly signals the ball dead.
- b. Additional untimed downs will be played until a down is free of the circumstances in Rule 3-2-3-a (above).
- c. If a touchdown is scored during a down in which time in a period expires, the period is extended for the try (**Exception:** Rule 8-3-2-a).

Approved Ruling 3-2-3

- i. During the extension of a period after the ball is ready for play and before the snap, Team A commits a foul. **RULING:** Dead-ball foul. Team A is penalised for the foul and is entitled to complete the down. [Cited by 3-2-3-a]
- ii. Time expires during Team A's free kick at the end of the second quarter. A1 is offside on the kick. **RULING:** Penalty — Five yards from the previous spot, the end of Team B's run, or the touchback spot, and the period is extended. Repeat the free kick or Team B is awarded an untimed down. [Cited by 3-2-3-a]
- iii. Time expires during Team A's attempted field goal at the end of the second quarter. Team B was offside. **RULING:** Penalty — Five yards from the previous spot, the period is extended (Rule 10-2-2-d-4-a). [Cited by 3-2-3-a]
- iv. A Team A player interferes with the opportunity to catch a kick (not a try) during a down in which time expires in the first quarter. **RULING:** Penalty — 15 yards from the spot of the foul. The period is not extended and the penalty will be enforced at the beginning of the second quarter. [Cited by 3-2-3-a]
- v. Team A scores a touchdown during a down in which time expires. After the touchdown, but before the try, either team fouls. **RULING:** The period is extended only for the try. The penalty may be enforced on the try or the succeeding kickoff, or the succeeding spot in extra periods. [Cited by 10-2-5-c, 3-2-3-a]
- vi. Team A scores a touchdown during a down in which time expires. During Team A's successful try, Team B fouls. **RULING:** The period is not extended for the kickoff. Team A may accept the penalty and repeat the try, or decline the penalty and accept the score. Penalties for personal fouls and unsportsmanlike conduct are enforced on the subsequent kickoff or the succeeding spot in extra periods. [Cited by 10-2-5-e, 3-2-3-a, 8-3-3-b-1]

- VII. Team A scores a touchdown during a down in which time expires. After the try ends, either team commits a dead-ball foul. **RULING:** The try may be repeated for an accepted penalty if a live-ball foul occurred during the try; the penalty for the dead-ball foul will then also be enforced on the repeated try. The period is not extended to enforce a penalty for a dead-ball foul. If accepted, this penalty must be enforced on the kickoff to start the next period or at the succeeding spot in extra periods [Cited by 10-2-5-e, 3-2-3-a, 8-3-3-d-2, 8-3-5]
- VIII. Time expires in the first half on a play in which A12 is beyond the neutral zone when they complete a pass to A88 in Team B's end zone. **RULING:** Team B accepts the penalty to nullify the score, and at the option of the offended team the period is not extended because the penalty includes loss of down. The first half ends. [Cited by 3-2-3-a-1, 3-2-3-a]

Timing Devices

- ARTICLE 4. a. *Game clock.* Playing time shall be kept with a game clock that may be either a stopwatch operated by an official on the field, or a game clock operated by an assistant under the direction of the appropriate judge. The type of game clock and the location of the game clock operator shall be determined by the game management. The game clock operator may be located on the sideline or in the press box area. If the clock operator is in the press box, it is recommended the location is between the goal lines. This location shall be shielded from public interference and shall afford a direct and unobstructed view of the playing field. The game clock shall not display fractions of seconds.
- b. *40-Second Clock.*
1. When an official signals that the ball is dead, the play clock shall begin a 40-second count.
 2. If the 40-second clock does not start or the count is interrupted for reasons beyond the control of the officials or the play-clock operator (e.g. clock malfunction), the referee shall stop the game clock and signal (both palms open in an over-the-head pumping motion) that the play clock should be reset at 40 seconds and started immediately.
 3. In the event that the 40-second clock is running and reads 20 before the ball is ready to be snapped, the referee shall signal that the play clock be set at 25 seconds. If there is a delay in doing this, the referee shall declare a timeout and signal that the play clock be set at 25 seconds. When play is to be resumed, the referee will give the ready-for-play signal [S1] and the play clock shall begin the 25-second count. The game clock will start on the snap unless it had been running when the referee declared a timeout; in that case, it will start on the referee's signal (Rule 3-3-2-f). (**A.R. 3-2-4:I, II and III**)
- c. *25-Second Clock.* If the officials signal the game clock to be stopped for any of the following reasons, **the play clock shall** be set at 25 seconds:
1. Penalty administration.
 2. Charged team timeout.
 3. Two-minute warning.
 4. Media timeout.
 5. Timeout for an injury to or a helmet coming off a player or players on the offensive team only. The play clock is set to 40 seconds for an injury to or helmet coming off a player or players on the defensive team, or if injuries or helmets off are by both teams. This rule only applies if the injury and/or helmet off was the only reason for stopping the clock. **If the game clock was also stopped for any other reason listed here, the play clock shall be set to 25 seconds.** A 25-second play clock will always be used after a charged team timeout or the two-minute warning. (**A.R. 3-2-4:V**)
 6. Measurement.
 7. Team B is awarded a first down other than after a free kick.
 8. After a kick down, other than a free kick where Team B will next snap the ball.
 9. Scores other than a Team A touchdown (not the try).

10. Start of each period.
11. Start of a team's possession series in an extra period.
12. Video review.
13. Other administrative stoppage.

When play is to be resumed, the referee will give the ready-for-play signal [S1] and the play clock will begin its count.

- d. *Device malfunction.* If a visual 40/25-second timing device becomes inoperative, both coaches shall be notified by the referee immediately and both clocks shall be turned off.

Approved Ruling 3-2-4

- I. When the ball is dead after a running play that ends out of bounds, the 40-second play clock is started. The umpire (or centre judge) receives the ball from the line judge, and as they are placing it on the ground, they see that it is not a legal game ball. They toss the ball to the line judge who attempts to get a legal ball from the ball person. **RULING:** If the play clock reads 20 seconds or less before the correct ball is in from the sideline and ready for play, the referee will attempt to reset the play clock without stopping the game clock. If the play clock is not quickly reset, the referee declares a timeout, the play clock is reset to 25 seconds and signals ready-for-play. The game clock starts on the snap unless it had been running when the referee declared a timeout. [Cited by 3-2-4-b-3]
- II. When the ball is dead after a running play that ends in the side zone, the officials have difficulty getting the ball in to the hash mark. As the play clock nears 20 seconds, the umpire (or centre judge) places the ball on the ground, and by the time the officials are ready, the play clock is somewhat below 20 when the umpire (or centre judge) steps away. **RULING:** Without stopping the game clock, the referee gives the "pump" signal to indicate that the play clock is to be reset to 25. If the play clock is quickly reset to 25, the game clock does not stop. Only if the play clock operator does not quickly respond to the referee's "pump" signal will the referee declare a timeout, signal for the play clock to be set at 25, and then signal to start both the play and game clocks. [Cited by 3-2-4-b-3]
- III. Team A scores a touchdown and the 40-second play clock is started. Without stopping the game, the referee receives positive confirmation from the video judge that the touchdown is good. The play clock displays: (a) 20 or more seconds, or (b) 19 or fewer seconds. **RULING:** The referee (a) signals to clear the centre judge or umpire and to allow the ball to be snapped. (b) The referee will signal the play clock be reset to 25 seconds, and will then signal to clear the centre judge or umpire and allow the ball to be snapped. [Cited by 3-2-4-b-3]
- IV. Team A scores a touchdown and the 40-second play clock is started. With less than 25 seconds on the play clock, Team A's head coach or team captain requests the ball be moved to the left hash mark. **RULING:** The officials will not honour the request. Team A may call a timeout to relocate the ball unless preceded by a Team A foul or offsetting fouls. [Cited by 8-3-2-c]
- V. 1/10 @ A-25. Early in the 4th quarter, back A21 takes a handoff and runs for a 15-yard gain and is down inbounds. During the play, A88 is guilty of holding at the A-30, and (a) B54's helmet comes off during the play (not a direct result of a foul) or (b) B54 is injured on the play. **RULING:** The holding foul by A88 will be penalised 10 yards from the spot of the foul and it will be 1/15 @ A-20. In both (a) and (b), the play clock will be set to 25, and both the play clock and game clock will be started on the referee's signal. [Cited by 3-2-4-c-5]
- VI. 2/10 @ B-40. Late in the game, A22 runs for 8 yards and is tackled short of the line to gain. The game clock reads 1:58 when A22 is downed. B54's helmet came off (not a direct result of a foul) during the play. **RULING:** The game clock is stopped at 1:58 for the two-minute warning and for B54's helmet being off. Even with a Team B helmet off, the play clock will be set to 25 seconds following the two-minute warning, and the game clock will start on the snap. (The same play clock treatment would occur with a Team B injury on the play.)

Minimum time for a play after spiking the ball

- ARTICLE 5. a. If the game clock is stopped and will start on the referee's signal with three or more seconds remaining in the quarter, the offense may reasonably expect to throw the ball directly to the ground (Rule 7-3-2-f) and have enough time for another play.
- b. With two seconds or one second on the game clock there is enough time for only one play. (**A.R. 3-2-5:I**)

Approved Ruling 3-2-5

- I. Late in a quarter Team A, out of timeouts, makes a first down, stopping the clock which reads 0:03. Team A intends to spike the ball and run an additional play. The referee appropriately blows their whistle and signals, which starts the game clock. The quarterback takes the snap and raises the ball high over their head before throwing it directly to the ground. The game clock shows 0:00. **RULING:** Time in the quarter has expired. Although there were 3 seconds on the game clock when the referee signalled it to start, there is no guarantee of enough time to run an additional play other than spiking the ball. The offense must execute the spike in a timely manner. [Cited by 3-2-5-b]

SECTION 3. Timeouts: Starting and Stopping the Clock**Timeout**

- ARTICLE 1. a. An official shall signal timeout when the rules provide for stopping the clock or when a timeout is charged to a team or to the referee. Other officials should repeat timeout signals. The referee may declare and charge themselves with a discretionary timeout for any contingency not elsewhere covered by the rules (**A.R. 3-3-1:I, II and IV**).
- b. When a team's charged timeouts are exhausted or are not available and it requests a timeout, the officials shall not acknowledge the request (Rule 3-3-4) (**A.R. 3-3-1:V, VI**).
- c. Once the game begins, players shall not practice with a ball on the field of play or the end zones except during the half-time intermission.

Approved Ruling 3-3-1

- I. 3/2 @ B-15. After the two-minute warning in the second quarter, A45 fumbles a live ball after gaining three yards. The officials cannot determine who has recovered the fumble, so the line judge signals the clock to stop while the ball is being located. A45 is found to be in possession of the ball and (a) has not made the line to gain or (b) has made the line to gain. **RULING:** The 40-second clock starts when the ball is declared dead. (a) The referee immediately will signal the game clock to start. (b) The game clock will start on the referee's signal when the ball is ready for play. Note: If the play clock is less than 20 seconds when the ball is ready for play, the referee will reset the play clock to 25 seconds. [Cited by 3-3-1-a, 3-3-2-e-1]
- II. On second and 14, A45 gains six yards and is downed with the ball in their possession. The linesman, mistaking the back stake of the line-to-gain chain for the front stake, erroneously signals the clock to stop. **RULING:** As soon as the error is detected by any official, the signal to start the clock shall be given by the game official detecting the error. [Cited by 3-3-1-a]
- III. Team A fumbles or the ball is loose after a backward pass. Several players dive on the ball, creating a "pile". **RULING:** The covering official(s) shall stop the clock and the 40-second clock shall start. Upon positive knowledge of who recovered, the referee will point in the direction governed by possession and start the game clock (a) immediately if Team A has recovered short of the line to gain (no first down), or (b) on the snap if Team B has recovered. [Cited by 3-3-2-e-8]
- IV. A shoelace, padlace, jersey, number or equipment breaks or tears. **RULING:** No referee's discretionary timeout permitted for repair or replacement. [Cited by 3-3-1-a]
- V. 3/5 @ B-30. It is late in the half and both teams have all their timeouts remaining. With Team A at the line and ready to snap the ball, the Team B head coach requests a timeout, and the timeout is granted. After the timeout, both teams are in formation and the ball is ready for play. (a) Team B head coach requests a timeout, or (b) Team A head coach requests a timeout. **RULING:** (a) The officials shall not acknowledge the timeout request. Team B still has 2 timeouts remaining, but since they have already called a timeout in the dead-ball period, a timeout is not available for Team B, (b) Team A timeout is granted. Since they have timeouts remaining and have not called a timeout in this dead-ball period, Team A has a timeout available. [Cited by 3-3-1-b, 3-3-4-a]
- VI. 3/5 @ B-30. It is late in the half and both teams have all their timeouts remaining. With Team A at the line and ready to snap the ball, the Team B head coach requests a timeout, and the timeout is granted. After the timeout, both teams are in formation and the ball is ready for play. Just before the snap, A77 commits a false start. Team A is penalised 5 yards creating a 3/10 situation. Both teams are back in formation with the ball ready for play, and Team B head coach requests a timeout. **RULING:** The officials shall not acknowledge the Team B head coach's timeout request. Team B still has 2 timeouts remaining, but since they have already called a timeout in the dead-ball period, a timeout is not available for Team B. Because the false start is a dead-ball foul, we are still in the same dead-ball period from when Team B called a timeout, so a timeout is not available to Team B. [Cited by 3-3-1-b, 3-3-4-a]

Starting and Stopping the Clock

ARTICLE 2. ▽ If the margin in the score becomes more than 34 points, a *running clock session* will start. During a running clock session, the game clock will stop only for reasons marked * below. For other events listed here, the clock will keep running. (**Exceptions:** Competitions may adopt regulations to:

1. forgo the running clock rule completely;
 2. forgo the rule only in the first half of a game; (**A.R. 3-3-2:XIII**)
 3. limit the running clock rule to use after an elapsed time no later than 2 hours 15 minutes after kickoff, but only in games that are broadcast live;
 4. reduce the score margin below 34 points.)
- a. *Free Kick*. After the ball is free-kicked, the game clock shall be started on an official's signal when the ball is legally touched in the field of play, or when it crosses the goal line after being touched legally by Team B in its end zone. It is subsequently stopped on an official's signal when the ball is dead by rule. (**A.R. 3-3-2:VII**)
 - b. *Scrimmage Down*. When a period begins with a scrimmage down, the game clock shall be started when the ball is legally snapped. On all other scrimmage downs, the game clock shall be started when the ball is legally snapped (Rule 3-3-2-d) or on a prior signal by the referee (Rule 3-3-2-e). The game clock shall not run during a try, during an extension of a period or during an extra period. (**A.R. 3-3-2:I-IV**)
 - c. *After a Score*. The game clock shall stop on an official's signal after a touchdown, field goal or safety. It shall be started again as in (a) above unless an accepted penalty erases the score or the down is repeated in which cases it shall be started when the ball is legally snapped.
 - d. *Starts on the Snap*. For each of the following, the game clock is stopped on an official's signal. If the next play begins with a snap, the game clock will start on the snap:
 1. Touchback (provided Team B will next snap the ball).
 2. A Team A ball carrier, fumble or backward pass is ruled out of bounds anytime after the two-minute warning in the 2nd or 4th quarters. (**Exception:** After a Team A forward fumble goes out of bounds, the clock starts on the referee's signal.)
 3. Team B is awarded a first down and will next snap the ball. (**A.R. 3-3-2:V**)
 4. A forward pass is ruled incomplete.
 5. A team is granted a charged timeout. *
 6. The ball becomes illegal. *
 7. A period ends. *
 8. A legal kick down ends. (**A.R. 3-3-2:VI**)
 9. A return kick is made.
 10. A scrimmage kick is made beyond the neutral zone.
 11. Team A commits a delay-of-game foul while in a scrimmage kick formation.
 12. Two-minute warning. *
 - e. *Starts on the Referee's Signal*. For each of the following reasons, the game clock is stopped on an official's signal. If the next play begins with a snap, the game clock will start on the referee's signal:
 1. Team A is awarded a first down, either through play or by penalty (**A.R. 3-3-1:I**).
 2. A Team A forward fumble goes out of bounds.
 3. A Team A ball carrier, fumble or backward pass is ruled out of bounds before the two-minute warning in the 2nd or 4th quarters.
 4. To complete a penalty (**Exception:** Rule 3-4-6-b). *

5. An injury timeout is allowed for one or more players or an official (**A.R. 3-3-6:I-V**). *
 6. An inadvertent whistle is sounded.
 7. A possible first-down measurement. *
 8. Both teams cause a delay in making the ball ready for play (**A.R. 3-3-1:III**).
 9. A live ball comes into possession of an official.
 10. A head coach requests a conference or video review. *
 11. The referee grants a media timeout. *
 12. The referee declares a discretionary timeout. *
 13. The referee declares a timeout for unfair noise (Rule 9-2-1-b-5).
 14. An illegal pass is thrown to conserve time (**A.R. 7-3-2:II-VII**) (*Exception:* Rule 3-4-6-b).
 15. The referee interrupts the 40/25-second count.
 16. A player's helmet comes completely off through play.
 17. When either team commits a dead-ball foul. *
- f. *Snap Supersedes Referee's Signal.* Whenever one or more incidents that cause the game clock to be started on the referee's signal (Rule 3-3-2-e) occur in conjunction with any that cause it to be started on the snap (Rules 3-3-2-c and 3-3-2-d), it shall be started on the snap. (*Exception:* Rule 3-4-6 (10-second runoff) supersedes this rule, other than when a team is granted a charged timeout. (**A.R. 3-3-2:VIII-IX**))
- g. *Running clock.*
1. During a running clock session, the clock will always be started on the ready for play rather than the snap. (**A.R. 3-3-2:XI-XII**)
 2. If, during a running clock session, the margin in the score continues to be more than 24 points, the running clock session will continue. If the margin drops to 24 or fewer points, the running clock session will end immediately on the relevant score and normal clock rules will apply unless and until the margin becomes more than 34 points again. (*Exception:* If a competition reduces the score margin to start a running clock session below 34 points, the margin to end it will be 10 points lower.) (**A.R. 3-3-2:IX-X**)

Approved Ruling 3-3-2

- I. Fourth and six. Team A's running play, which ends inbounds, gains (a) eight yards or (b) five yards. B1 is offside during the play. **RULING:** (a) Team A's ball. First and 10. The clock starts on the referee's signal. (b) Team A's ball. Fourth and one. The clock starts on the referee's signal. (Rules 3-3-2-e-1 and 3-3-2-e-4) [Cited by 3-3-2-b]
- II. Fourth and four. Team A's running play, which ends inbounds, gains (a) six yards or (b) three yards. B1 is offside during the play. **RULING:** (a) Team A's ball. First and 10. The clock starts on the referee's signal. (b) Team A's ball. First and 10 after accepting the penalty. The clock starts on the referee's signal. [Cited by 3-3-2-b]
- III. Third and four. Team A's pass is intercepted by B1, who is downed inbounds. B2 was offside during the play. **RULING:** Team A's ball. First and 10. The clock starts on the referee's signal. Although the clock was stopped to award Team B a first down, Team B will not next snap the ball. [Cited by 3-3-2-b]
- IV. Late in the second or fourth quarter, ball carrier A37 goes out of bounds. When the game clock is stopped it reads (a) 2:00 or (b) 1:59. **RULING:** In both (a) and (b), the game clock starts on the snap because of the two-minute warning. [Cited by 3-3-2-b]
- V. Late in the second or fourth quarter, Team A has second and eight. B44 intercepts a legal forward pass and carries the ball out of bounds. B79 is in the neutral zone at the snap. When the game clock is stopped it reads (a) 2:00, or (b) 1:59. **RULING:** Team A accepts the penalty and retains possession of the ball. In both (a) and (b), the game clock will start on the snap because of the two-minute warning. [Cited by 3-3-2-d-3]
- VI. Fourth and eight at the A-12, late in the fourth quarter. The punt is blocked and the ball does not cross the neutral zone. At the A-10, back A22 recovers the ball and throws a forward pass to eligible A88 who is tackled at the B-3. The game clock reads 0:03. **RULING:** Team A's ball at the B-3, first and goal. The

game clock starts on the snap because of the legal kick play. (Rules 3-3-2-d-8, 3-3-2-e-1, 3-3-2-f) [Cited by 3-3-2-d-8]

- VII. Free Kick @ A-35. Team A executes an onside kick. After the ball has travelled 10 yards, (a) B21 gives a valid fair catch signal and makes a clean catch; (b) A80 is first to touch the ball and makes a clean legal catch or recovery; (c) B21 catches or recovers the ball and immediately goes to the ground; (d) B21 makes a clean recovery with their knees on the ground. **RULING:** The ball is declared dead and (a) No time will run off the clock; (b) No time will run off the clock; (c) the clock operator shall start the clock when the ball is legally touched and will stop the clock when the ball is declared dead (Rule 3-3-2-a); (d) No time will run off the clock. [Cited by 3-3-2-a]
- VIII. Third and five at the B-15 late in the fourth quarter, with Team A trailing 10-7. Quarterback A11 rolls out and is at the B-12 when they throw a forward pass that is incomplete. When the ball is dead the game clock shows 0:13. Team B accepts the penalty for the illegal forward pass. **RULING:** Fourth and seven at the B-17. Team B has the option for a 10-second runoff. Assuming that Team B accepts the runoff, the game clock is set at 0:03 and starts on the referee's signal. [Cited by 3-3-2-f, 3-4-6-b-Note]
- IX. The score is 35-0 and a running clock session has started. It then becomes 35-6. The trailing team scores a touchdown to make the score 35-12. **RULING:** The clock stops when the touchdown is scored – the margin is no longer more than 24 points. Normal clock rules then apply unless/until the leading team increases the lead to more than 34 points again. [Cited by 3-3-2-f, 3-3-2-g-2]
- X. The score is 41-10 during a running clock session. The trailing team scores a touchdown to make the score 41-16. Then they kick the extra point to make the score 41-17. **RULING:** The clock stops when the try is scored – it is only then that the margin drops to 24 points. [Cited by 3-3-2-g-2]
- XI. The score is 30-0. The leading team scores a touchdown to make the score 36-0. **RULING:** The clock is stopped for the touchdown and will restart when the ball is declared ready for play on the ensuing try, but will not stop again until one of the events marked * occurs. (Rule 3-3-2-g) [Cited by 3-3-2-g-1]
- XII. The score is 28-0. The leading team scores a touchdown to make the score 34-0. Then they score a try touchdown to make the score 36-0. **RULING:** The clock was stopped for the original touchdown and will restart when the ball is declared ready for play on the ensuing free kick, and will not stop again until one of the events marked * occurs. [Cited by 3-3-2-g-1]
- XIII. In a competition that forgoes the running clock rule in the first half, one team takes a 35 point lead in the second quarter. Before half time, the trailing team reduces the margin to 35-6. **RULING:** A running clock session does not start. No session could begin in the first half, and the conditions for one do not exist at the start of the second half. [Cited by 3-3-2 Exception 2]

Suspending the game

ARTICLE 3. a. The referee may suspend the game temporarily when conditions warrant such action.

- b. When the game is stopped by actions of a person(s) not subject to the rules, or for any other reasons not specified in the rules, and cannot continue, the referee shall:
1. Suspend play and direct the players to their team areas.
 2. Refer the problem to those responsible for the game's management.
 3. Resume the game when conditions are satisfactory.
- c. ∇ If a game is suspended under Rules 3-3-3-a and b before the end of the fourth period and cannot be resumed, there are four possible options:
1. Resume the game at a later date;
 2. Terminate the game with a determined final score;
 3. Forfeit of the game; or
 4. Declare a no contest.

The option that takes effect shall be determined by competition regulations.

- d. ∇ If a game is suspended under Rules 3-3-3-a and b after four periods of play and cannot be resumed, the game shall be ruled a tie. The final score shall be the score at the end of the last completed period. (Note: If a winner must be determined in a competition playoff game, competition regulations shall determine when and where the game will be resumed.)

- e. A suspended game, if resumed, will begin with the same time remaining and under the identical conditions of down, distance, field position and player eligibility.

Charged Team Timeouts

ARTICLE 4. When timeouts are not exhausted and are available, an official shall allow a charged team timeout when requested by any player or head coach when the ball is dead. Consecutive charged team timeouts are not allowed by the same team in any specific dead-ball period.

- a. Each team is entitled to three charged team timeouts during each half, with no more than one charged team timeout available per team, per specific dead-ball period. A successful replay challenge does not count as a timeout. (A.R. 3-3-4:II) (A.R. 3-3-1:V, VI).
- b. After the ball is declared dead and before the snap, a legal substitute may request a timeout if they are between the nine-yard marks. (A.R. 3-3-4:I)
- c. A player who participated during the previous down may request a timeout between the time the ball is declared dead and the snap without being between the nine-yard marks. (A.R. 3-3-4:I)
- d. A head coach who is in, or in the vicinity of, their team area or coaching box may request a timeout between the time the ball is declared dead and the next snap.
- e. A player, incoming substitute or head coach may request a head coach's conference with the referee if the coach believes a rule has been enforced improperly. If the rule enforcement is not changed, the coach's team will be charged a timeout, or a delay penalty if all timeouts have been used.
 1. Only the referee may stop the clock for a head coach's conference.
 2. A request for a head coach's conference or video review must be made before the ball is snapped or free-kicked for the next play and before the end of the second or fourth period (Rule 5-2-9).
 3. After a head coach's conference or video review, the team timeout is granted if charged by the referee.

Approved Ruling 3-3-4

- I. Before the snap, a legal substitute of either team running from the bench requests a timeout before being within the nine-yard marks. They then request a timeout again after being within the nine-yard marks. **RULING:** Initial timeout request not granted. Second request granted (Rule 7-1-3-b). [Cited by 3-3-4-b, 3-3-4-c, 7-1-3-b-1]
- II. 3/10 @ B-40. Early in the 2nd quarter, Team A has all 3 timeouts remaining. A12 throws to A88 but the pass is ruled incomplete. The Team A head coach calls timeout to challenge the ruling on the field of an incomplete pass. Replay overturns the ruling on the field to a catch at the B-31. After the ball is ready at the B-31, Team A breaks the huddle late in the play clock, and the Team A head coach attempts to call a timeout just before the play clock displays zero. **RULING:** The timeout is granted. Since replay upheld the challenge and Team A was not charged with a timeout, it is legal to request a timeout. [Cited by 3-3-4-a]
- III. 3/10 @ B-40. Late in the 2nd quarter following the two-minute warning, Team A is trailing by five points and has all 3 timeouts remaining. A12 throws to a diving A88 but the pass is ruled incomplete, and the game clock is stopped at 0:15. The Team A head coach calls timeout to challenge the ruling on the field of an incomplete pass. Replay overturns the ruling on the field to a catch at the B-31. **RULING:** With the overturn, Team A will have 4/1 @ B-31. Since the overturn was after the two-minute warning and the replay review resulted in the on-field ruling being overturned, and the correct ruling would not have stopped the game clock, the play is subject to a 10-second runoff. After a successful coach's challenge, either team may use a timeout to avoid the 10-second runoff. If Team A uses their timeout here to avoid the runoff, they will have 2 timeouts remaining.
- IV. 3/10 @ B-40. Early in the 2nd quarter, team A has all 3 timeouts remaining. A12 throws to A88 but the pass is ruled incomplete. The Team A head coach calls timeout to challenge the ruling on the field of an incomplete pass. Replay overturns the ruling on the field to a catch at the B-31. After the ball is ready at the B-31, Team A breaks the huddle late in the play clock, and the Team A head coach attempts to call a timeout just before the play clock displays zero. **RULING:** The timeout is granted. Since replay upheld the challenge and Team A was not charged with a timeout, it is legal to request a timeout.

Two-minute Warning

- ARTICLE 5. a. When the game clock is running and the ball is not live, the referee shall stop the clock with exactly two minutes remaining in the second and fourth quarters for a two-minute warning. If the ball is live when the game clock reaches two minutes in the second and fourth quarters, play will continue, and the referee or covering official shall stop the clock when the ball is declared dead for a two-minute warning.
- b. If relevant, the media broadcast partner will hold back at least one media timeout to coincide with the two-minute warning.

Injury Timeout

ARTICLE 6. a. In the event of an injured player(s):

1. An official will declare a timeout and the player(s) must leave the game. They must remain out of the game for at least one down, even if their team is granted a team timeout. When in question, officials will take a timeout for an injured player. **If a player presents as injured after the ball is spotted by officials, that team will be charged a team timeout or a delay penalty if all timeouts have been used (A.R. 3-3-6:X-XII).**
 2. The player(s) may not return to the game until they receive approval of medical personnel designated by their team.
 3. Officials, coaches and trainers shall give special attention to players who exhibit signs of a concussion. (See Appendix C.)
 4. Whenever a participant (player or game official) is bleeding, has blood saturated on the uniform, or has blood on exposed skin, the player or game official shall go to the team area and be given appropriate medical treatment. They may not return to the game without approval of medical personnel. **(A.R. 3-3-6:I-VII)**
- b. Feigning an injury for any reason is unethical. An injured player must be given full protection under the rules, but feigning an injury is dishonest, unsportsmanlike and contrary to the spirit of the rules. For questionable game action, **a participating team or official** has the option to report the matter to the relevant disciplinary authority, who may choose to take action against the player(s) and coach(es) involved. Attention is directed to the statement in "The Football Code" (Coaching Ethics, section g).
- c. An injury timeout may follow a charged team timeout.
- d. The referee will declare a timeout for an injured official.
- e. Following a timeout for an injured player of the defensive team (potentially combined with a timeout for a defensive helmet off), the play clock shall be set at 40 seconds except after a charged team timeout or when the game is stopped for the two-minute warning. This rule only applies if the injury and/or helmet off was the only reason for stopping the clock. **If the game clock was also stopped for any other reason listed in Rule 3-2-4-c, the play clock shall be set to 25 seconds.**
- f. *Ten-Second Runoff*. If the player injury is the only reason for stopping the clock (other than their or a teammate's helmet coming off, Rule 3-3-10) any time after the two-minute warning in the 2nd or 4th quarters, the opponent has the option of a 10-second runoff. **Exception: If a player injury occurs on a play where there is a temporary stoppage of the clock for a first down, and the clock is stopped with 10 seconds or less remaining in the 2nd or 4th quarters, the opponent has the option of a 10-second runoff. The 10-second runoff may be avoided by the use of a charged team timeout if available) (A.R. 3-3-6:XIII-XVI).**
1. The play clock will be set at 40 seconds for an injury to a player of the defensive team and at 25 seconds for an injury to a player of the offensive team (Rule 3-2-4-c-5).
 2. Rule 3-4-6 applies. **(A.R. 3-3-6:VIII-XX)**

Approved Ruling 3-3-6

- I. At the end of a play, with the game clock running, the referee notices that A22 is bleeding. **RULING:** The referee stops the clock and declares an injury timeout. A22 leaves the field of play (or the end zone) for treatment by appropriate medical personnel. Unless there is also an injury to a Team B player the play clock is set to 25 seconds and starts on the ready-for-play signal (Rule 3-2-4-c-5). [Cited by 3-3-2-e-5] [Cited by 3-3-6-a-4]
- II. After being treated for a bleeding or oozing wound, A22 attempts to enter the game before the next snap. **RULING:** A22 must remain out of the game for at least one play. In any event, they may return only on the approval of their team's medical personnel. [Cited by 3-3-2-e-5, 3-3-6-a-4]
- III. B52's jersey has blood spots on it. **RULING:** Unless the official determines that the jersey is saturated with blood, B52 may remain in the game. (Note: Saturated is defined as soaked with moisture or drenched. If blood has penetrated through a garment to the skin or can be transferred to another player or game official, the garment is saturated.) [Cited by 3-3-2-e-5, 3-3-6-a-4]
- IV. An official notices that blood has soaked through B10's jersey. **RULING:** B10 must leave the game until medical personnel have determined if the jersey must be replaced. [Cited by 3-3-2-e-5, 3-3-6-a-4]
- V. B10 tackles A12. An official determines that B10's jersey is saturated with blood from a cut on A12's arm. **RULING:** Both players must leave the game – A12 for treatment of their open wound, B10 for a determination by medical personnel as to whether they have to replace their jersey. [Cited by 3-3-2-e-5, 3-3-6-a-4]
- VI. During a dead-ball interval, A85 notices a bleeding cut on their arm. They voluntarily go to the team area and are replaced by A88. **RULING:** This is a legal substitution and there is no variation in game timing. A85 may return to the game after the injury has been treated, but they must adhere to substitution rules. [Cited by 3-3-6-a-4]
- VII. On second down the Team A ball carrier is tackled inbounds. The clock is then stopped for an injury to a player of Team B. (a) No other players are injured on the play. (b) There is also an injury to a player of Team A. (c) The referee grants a media timeout. **RULING:** In (a), (b) and (c) upon preparing to resume play the referee will indicate that the play clock be set to 40 seconds. Both the play clock and the game clock will start on the ready-for-play signal. [Cited by 3-3-6-a-4]
- VIII. Late in the half, ball carrier A35 is tackled. B79 goes to the ground with an injury, and the officials stop the game clock, which shows (a) 12 seconds; (b) eight seconds. **RULING:** Team A has the option of a 10-second runoff. If there is no 10-second runoff the game clock starts on the snap. If Team A accepts the option, (a) there will be two seconds on the game clock which will start on the referee's signal; (b) time in the half has expired. [Cited by 3-3-6-f-2]
- IX. Late in the half, ball carrier A35 is tackled beyond the line to gain. B79 goes to the ground with an injury. **RULING:** There is no option for a 10-second runoff because the game clock stops on the first down as well as the injury. The game clock starts on the referee's signal. [Cited by 3-3-6-f-2]
- X. 3/10 @ B-45. QB A12 runs for a 1st down at the B-15. After the ball is declared dead and is spotted by the back judge, B75 is moving to get to his side of the ball and then drops to the ground and presents as injured. The officiating crew (a) is clear that B75 went down after the ball was spotted or (b) is unsure of the timing of when B75 went down. **RULING:** (a) The clock is stopped for an injury timeout for B75 and Team B is charged with a team timeout. (b) During the injury timeout, if available, replay can assist the crew on the field in determining the timing of the injury in relation to the ball being spotted. Without Instant Replay, when in question, Team B will not be charged a team timeout. [Cited by 3-3-6-a-1, 3-3-6-f-2]
- XI. 3/10 @ B-45. QB A12 runs for a 1st down at the B-15. After the ball is declared dead and is spotted by the back judge, the Umpire notices that B55 is experiencing the signs and symptoms of a concussion (see Appendix C). **RULING:** The officials will stop the game immediately for an injury timeout to ensure B55 is evaluated immediately by the appropriate health care professional. Team B will not be charged with a timeout. [Cited by 3-3-6-a-1, 3-3-6-f-2]
- XII. 3/10 @ B-30. Team A lines up for a potential game winning field goal with 0:04 remaining on the stopped game clock. Team B has 3 timeouts remaining and calls a timeout just before the snap to ice the kicker. Both teams return and are in position and the Referee signals the ball back in play. Before the snap, B75 who is in position, falls down injured. **RULING:** B75 presents as injured after the ball was spotted, but consecutive charged team timeouts are not allowed in any individual dead ball period. Team B will be charged with a 5-yard delay of game penalty, and it will be 3/5 @ B-25. [Cited by 3-3-6-a-1, 3-3-6-f-2]

- XIII. 3/10 @ B-30. Late in the 4th quarter, Team A completes a pass over the middle and A88 is tackled inbounds at the B-15 for a first down. A88 remains on the ground and the Referee declares an official's timeout for injury. There is (a) 0:05 on the game clock; (b) 0:15 on the game clock. **RULING:** In (a), Team B has the option of a 10-second runoff. Team A can avoid the runoff if it has a charged timeout remaining. The game is over if the 10-second runoff option is exercised. In (b), there is no option for a 10-second runoff. The clock will start on the Referee's signal following the injury timeout. [Cited by 3-3-6-f-2, 3-3-6-f]
- XIV. 3/10 @ B-30. Late in the 4th quarter, Team A completes a pass over the middle and A88 is tackled inbounds at the B-15 for a first down. At the snap, (a) Team B had 12 players on the field; (b) Team A's formation was not legal; (c) A77's helmet came off during the play (not a direct result of a foul by an opponent). A88 remains on the ground and the Referee declares an official's timeout for injury. There is 0:05 remaining on the game clock. **RULING:** In (a) there is no option for a 10-second runoff since the official's timeout includes addressing the Illegal Substitution by Team B; (b) there is no option for a 10-second runoff since the official's timeout includes addressing the Illegal Formation by Team A; (c) Team B has the option of a 10-second runoff. Team A can avoid the runoff if it has a charged timeout remaining. The game is over if the 10-second runoff option is exercised. [Cited by 3-3-6-f-2, 3-3-6-f]
- XV. 3/10 @ B-30. Late in the 4th quarter, Team A's pass is (a) complete and A88 runs out of bounds at the B-15 for a first down; (b) is incomplete. A88 remains on the ground and the Referee declares an official's timeout for injury. There is 0:05 remaining on the game clock. **RULING:** There is no option for a 10-second runoff since (a) the runner is out of bounds stopping the game clock; (b) the pass is incomplete stopping the game clock. [Cited by 3-3-6-f-2, 3-3-6-f]
- XVI. 3/10 @ B-30. Late in the 4th quarter, Team A completes a pass over the middle and A88 is tackled inbounds at the B-15 for a first down. B27 remains on the ground and the Referee declares an official's timeout for injury. There is (a) 0:05 on the game clock; (b) 0:15 on the game clock. **RULING:** In (a), Team A has the option of a 10-second runoff, which they may decline and the clock will start on the snap. In (b), there is no option for a 10-second runoff. The clock will start on the Referee's signal following the injury timeout. [Cited by 3-3-6-f-2, 3-3-6-f]
- XVII. A play ends inbounds with 1:03 left in the 4th quarter and the game clock continues to run. Five seconds later, an official sees an injured player and stops the clock. **RULING:** A 10-second runoff option applies because the clock was stopped for the injury and less than **two minutes** in the half remained when that happened. The time the play ended is not relevant unless the game clock should have stopped then. [Cited by 3-3-6-f-2]
- XVIII. 1st and 10 at midfield with 0:59 remaining in the game. A34 gains 5 yards on the play and is tackled inbounds. During the play, A78 is flagged for holding and B99 is injured on the play. **RULING:** The play clock is set to 25 seconds as the game clock was stopped both to administer the penalty and for the injury to B99. There is no option for a 10-second runoff. [Cited by 3-3-6-f-2, 3-4-6-a]
- XIX. 1st and 10 at midfield with 0:59 remaining in the game. A34 gains 5 yards on the play and is tackled inbounds. During the play, A78's helmet comes off and B99 is injured on the play. **RULING:** The play clock is set to 40 seconds as the game clock was stopped for an injury or helmet off on players of both teams. There is no option for a 10-second runoff. [Cited by 3-3-6-f-2, 3-4-6-d]
- XX. 1st and 10 at midfield with 0:59 remaining in the game. A34 gains 5 yards on the play and is tackled inbounds by B56 grabbing, twisting and pulling A34's face mask, which causes A34's helmet to come off. B99 is injured on the play. **RULING:** The play clock is set to 25 seconds because the game clock was stopped to administer the penalty, in addition to A34's helmet coming off and for the injury to B99. There is no option for a 10-second runoff. Due to the helmet foul, A34 may remain in the game. [Cited by 3-3-10-a, 3-3-6-f-2, 3-4-6-a]

Violation Timeouts

ARTICLE 7. For noncompliance with Rule 1-4-5-c-2, the team will be charged a timeout (Rule 3-4-2-b-2).

Length of Timeouts

ARTICLE 8. a. A charged team timeout requested by any player or head coach shall be one minute plus the five-second referee notification and the 25-second play clock interval. (**Exception:** Rule 3-3-4-e-3).

- b. Other timeouts shall be not longer than the referee deems necessary to fulfill the purpose for which they are declared, including a radio or TV timeout, but any timeout may be extended by the referee for the benefit of an injured player (Refer to Appendix A for the guidelines for game officials to use during a serious on-field player injury).
- c. If the team charged with a team timeout wishes to resume play before the expiration of one minute and its opponent indicates readiness, the referee will declare the ball ready for play.
- d. The length of a referee's timeout depends on the circumstances of each timeout.
- e. Penalty options must be exercised before a team timeout.
- f. The intermission after a safety, try or successful field goal shall be not more than one minute. It may be extended for radio or television.

Referee's Notification

ARTICLE 9. During a team timeout (Rule 3-3-8-a) the referee shall notify both teams after one minute. Five seconds later the referee shall declare the ball ready for play.

- a. When a third timeout is charged to a team in either half, the referee shall notify the field captain and head coach of that team.
- b. If a visual game clock is not the official timing device anytime after the two-minute warning in the 2nd or 4th quarters, the referee or their representative shall notify each captain and head coach of the time remaining each time the clock is stopped by rule. Also, a team representative may leave the team area along the limit line to relay timing information under these conditions.

Helmet Comes Off – Timeout

ARTICLE 10. a. If a player's helmet comes completely off through play, other than as the direct result of a foul by an opponent, the player must leave the game for the next down. The game clock will stop at the end of the down. The player may remain in the game if their team is granted a charged timeout (**A.R. 3-3-6:XX**).

- b. When the helmet coming off is the only reason for stopping the clock, other than due to an injury to the player or their teammate (Rule 3-3-6), the following conditions apply (**A.R. 3-3-10:I-III**):
 1. The play clock will be set at 25 seconds if the player is on offense and at 40 seconds if the player is on defense or for players on both teams except after a charged team timeout or when the game is stopped for the two-minute warning. **If the game clock was also stopped for any other reason listed in Rule 3-2-4-c, the play clock shall be set to 25 seconds.** Before the two-minute warning in the 2nd or 4th quarters, the game clock will start on the referee's signal.
 2. *Ten-Second Runoff*. Anytime after the two-minute warning in the 2nd or 4th quarters, **if** the clock was stopped for player(s) on one team only, the opponent has the option of a 10-second runoff, unless the helmet comes off as the direct result of a foul by the opponent. Rule 3-4-6 applies (**A.R. 3-3-10:IV, V**) (**A.R. 3-4-4:VI**).
- c. If the ball carrier's helmet comes off as in paragraph a (above), the ball is dead (Rule 4-1-3-q). If the player is not the ball carrier, the ball remains alive, but they must not continue to participate in the play beyond the immediate action in which they are engaged. Prolonged participation is a personal foul (Rule 9-1-17). By definition such a player is obviously out of the play (Rule 9-1-12-b).
- d. A player who intentionally removes their helmet during the down commits a foul for unsportsmanlike conduct (Rule 9-2-1-a-1-i).

Approved Ruling 3-3-10

- i. After the ball is dead, A55 blocks B33 at their waist, knocking them to the ground. As B33 hits the ground their helmet comes off. **RULING:** Dead-ball foul by A55, 15-yard penalty from the succeeding spot. B33 must leave the game for the next down as their helmet came off through play and not due to a helmet foul. B33 may remain in the game if Team B takes a timeout. [Cited by 3-3-10-b]

- II. Late in the first quarter ball carrier A22 is legally tackled, and their helmet comes off just after their back hits the ground. The game clock reads 0:00. **RULING:** A22 must leave the game for the next down, which will be the initial down of the second quarter. A22's helmet came off through play and there was no helmet foul by Team B. However, A22 may remain in the game if Team A takes a timeout. [Cited by 3-3-10-b]
- III. During the down A22's helmet comes off (no helmet foul by the defense) and B77 goes down with an injury. The ball carrier is tackled inbounds. When the clock is stopped it reads 0:58 in the fourth quarter. **RULING:** Unless Team A takes a charged timeout, A22 must leave the game for one play. The play clock is set at 40 seconds, due to the defensive injury, rather than 25 seconds due to the helmet coming off the offensive player. There is no option for a 10-second runoff because the clock stops for both the helmet off and the injury, and these occur for opposing players. [Cited by 3-3-10-b]
- IV. During the down A22's helmet comes off (no helmet foul by the defense) and A45 goes down with an injury. The ball carrier is tackled inbounds. When the clock is stopped it reads 0:58 in the fourth quarter. **RULING:** Because the injury and the helmet off occur to players on the same team, there is an option for a 10-second runoff. Team A may keep A22 in the game and also avoid the 10-second runoff by taking one charged timeout. [Cited by 3-3-10-b-2]
- V. During a running play that ends in bounds, a linebacker's helmet comes off. When the ball becomes dead the game clock is stopped and reads 0:45 in the second quarter. **RULING:** The play clock is set at 40 seconds. Team A has the option for a 10-second runoff. If Team A exercises this option, unless Team B is charged with a timeout, the game clock is set to 0:35 and starts on the referee's signal. If Team B uses a timeout to avoid the 10-second runoff, the game clock remains at 0:45, the play clock is set at 25 and starts on the referee's signal, and the game clock starts on the snap. [Cited by 3-3-10-b-2]

SECTION 4. Delays/Clock Tactics

Delaying the Start of a Half

ARTICLE 1. a. Each team shall have its players on the field for the opening play at the scheduled time for the beginning of each half. When both teams refuse to enter the field first for the start of either half, the home team must be the first to enter.

PENALTY – 15 yards from the succeeding spot [S21: DSH].

b. Game management is responsible for clearing the field of play and end zones at the beginning of each half so the periods may start at the scheduled time. Bands, speeches, presentations, homecoming and similar activities are under the jurisdiction of game management and a prompt start of each half is mandatory.

PENALTY – 10 yards from the succeeding spot [S21: DSH].

(Exception: The referee may waive the penalty for circumstances beyond the control of game management.)

Illegal Delay of the Game

ARTICLE 2. a. The officials shall make the ball ready for play consistently throughout the game. The play clock will start its count-down from either 40 seconds or 25 seconds, by rule depending on circumstances. A foul for illegal delay occurs if the play clock is at :00 before the ball is put in play (Rule 3-2-4).

b. Illegal delay also includes:

1. Deliberately advancing the ball after it is dead.
2. When a team has expended its three timeouts and commits a Rule 1-4-5-c-2 or 3-3-4-e infraction.
3. When a team is not ready to play after an intermission between periods, after a score, after a radio/television/team timeout, or any time the referee orders the ball put in play. **(A.R. 3-4-2:I)**
4. Defensive verbal tactics that disconcert offensive signals (Rule 7-1-5-a-5).
5. Defensive actions designed to cause a false start (Rule 7-1-5-a-4).

6. Putting the ball in play before it is ready for play (Rule 4-1-4).
7. Sideline interference (Rule 9-2-5).
8. Action clearly designed to delay the officials from making the ball ready for play. (**A.R. 3-4-2:II**)

PENALTY – Dead-ball foul. Five yards from the succeeding spot [S7 and S21: DOG/DOD].

Approved Ruling 3-4-2

- I. After any timeout, one of the teams is not ready to play. **RULING:** Illegal delay. Penalty — Five yards from the succeeding spot. [Cited by 3-4-2-b-3]
- II. On a running play late in the half the Team A ball carrier is tackled inbounds. Team B players are deliberately slow to "unpile" in an obvious attempt to consume time and prevent the officials from making the ball ready for play. **RULING:** Team B foul for delay of game. Penalty — five yards at the succeeding spot. The game clock will start on the snap (Rule 3-4-3). [Cited by 3-4-2-b-8]

Unfair Clock Tactics

ARTICLE 3. The referee has broad authority in the timing of the game.

- a. The referee shall order the game clock or play clock started or stopped whenever either team conserves or consumes playing time by tactics obviously unfair. This includes starting the game clock on the snap if the foul is by the team ahead in the score. As a guideline, referees should consider invoking this rule when the game clock is under five minutes of each half.
- b. If the game clock is stopped to complete a penalty for a foul by the team ahead in the score (or either team if the score is tied) anytime after the two-minute warning in the 2nd or 4th quarters and the clock would start by rule on the referee's signal, it will start on the snap, at the option of the offended team. The game clock will start on the ready-for-play signal after Team A throws an illegal forward or backward pass to conserve time (Rule 3-3-2-e-14) (**A.R. 3-4-3:I-VII**).
- c. If a player injury occurs or a player's helmet comes completely off through play on a play where there is a temporary stoppage of the clock for a first down, and the clock is stopped with 10 seconds or less remaining in the 2nd or 4th quarters, the opponent has the option of a 10-second runoff. The 10-second runoff may be avoided by the use of a charged team timeout if available.

Approved Ruling 3-4-3

- I. In an attempt to consume time in the fourth period, Team A stalls and the play clock expires. **RULING:** Foul for delay of game. Penalty — Five yards from the succeeding spot. The clock starts on the snap. [Cited by 3-4-3-b]
- II. After the two-minute warning in the fourth quarter and the clock running, Team B has no timeouts remaining. In an effort to conserve time, B77 crosses the neutral zone and touches a Team A player. **RULING:** Dead-ball foul. Penalty — Five yards from the succeeding spot. Because this play occurred after the two-minute warning, this foul comes under the 10-second runoff rule (Rule 3-4-4). [Cited by 3-4-3-b]
- III. After the two-minute warning in the second quarter and the clock running, Team B has no timeouts remaining. Ball carrier A12 throws a backward pass out of bounds from behind or beyond the neutral zone to conserve time. **RULING:** Penalty — Five yards from the spot of the foul and loss of down. Because this play occurred after the two-minute warning, this foul comes under the 10-second runoff rule (Rule 3-4-4). [Cited by 3-4-3-b, 7-2-1 Penalty]
- IV. A ball carrier throws an incomplete forward pass while beyond the neutral zone to conserve time. **RULING:** Penalty — Five yards from the spot of the foul and loss of down. The clock starts on the ready-for-play signal (Rule 7-3-2 Penalty). Note: If the play occurs anytime after the two-minute warning, this foul comes under the 10-second runoff rule (Rule 3-4-4). [Cited by 3-4-3-b, 7-3-2 Penalty]
- V. Late in the fourth quarter Team A trails by four points and is driving for a potential score. After a running play on which the ball carrier is tackled inbounds, Team B players are obviously and deliberately slow in letting them get to their feet or otherwise are employing tactics to delay the officials in making the ball ready for play. **RULING:** Dead-ball foul against Team B, delay of game. When the ball is ready for play, the referee will signal the 25-second clock to start, and the game clock will start on the snap. [Cited by 3-4-3-b]

- VI. Second and seven at the A-25. Team A is ahead in the score late in the second quarter. When ball carrier A22 is tackled in the field of play, the game clock reads 1:47. The umpire reports to the referee that they have a flag for holding by snapper A55. On the play, A22 gained (a) three yards; (b) nine yards. **RULING:** In both (a) and (b), after enforcement of the penalty, the game clock starts on the snap or on the referee's signal, at the option of Team B. [Cited by 3-4-3-b]
- VII. Team B is leading, and the clock is running with less than two minutes left in a half. Ball carrier A21 is tackled in bounds short of the line to gain. After the ball is dead, A65 and B50 are both flagged for unsportsmanlike acts. **RULING:** The clock starts on the ready for play. Because both teams fouled, Team A does not have the option to start the clock on the snap (Rule 3-4-3-b). [Cited by 3-4-3-b, 3-4-6-d]

10-second Runoff from Game Clock – Foul

ARTICLE 4. a. With the game clock running and anytime after the two-minute warning in the 2nd or 4th quarters, before a change of team possession if either team commits a foul that causes the clock to stop immediately and the penalty for the foul is accepted, the referee will subtract 10 seconds from the game clock at the option of the offended team. The fouls that fall into this category include but are not limited to:

1. Any foul that prevents the snap (e.g. false start, encroachment, defensive offside by contact in the neutral zone, etc.); (**A.R. 3-4-4:I-III, V**)
2. Intentional grounding to stop the clock; (**A.R. 3-4-4:VII**)
3. Incomplete illegal forward pass;
4. Backward pass thrown out of bounds to stop the clock;
5. Any other foul committed with the intent of stopping the clock.

The offended team may accept the yardage penalty and decline the 10-second runoff. If the yardage penalty is declined, the 10-second runoff is declined by rule.

- b. 10-second runoff procedures are specified in Rule 3-4-6.

Approved Ruling 3-4-4

- I. Second and 10 at the B-30. The game clock is running in the second half. Team A trails by two points and is out of timeouts. After the ball is ready for play lineman A66 commits a false start, and when the officials stop the game clock it reads (a) 13 seconds; (b) 8 seconds. Team B accepts the yardage penalty and the clock runoff. **RULING:** (a) Five-yard penalty with 10 seconds subtracted from the game clock, which is set at 3 seconds. Second and 15 at the B-35. The clock starts on the referee's signal. (b) The game is over. Team B wins. [Cited by 3-4-4-a-1]
- II. Second and 10 at the B-30. The game clock is running in the second half. Team A trails by two points and is out of timeouts. At the snap Team A has five players in the backfield. A22 carries for a three-yard gain to the B-27. When the ball is declared dead the game clock reads (a) 13 seconds; (b) 8 seconds. **RULING:** (a) and (b) Five-yard penalty, illegal formation. Second and 15 at the B-35. Because the illegal formation is not a foul that causes the clock to stop immediately, the 10-second runoff does not apply. After the penalty is administered the game clock starts on the referee's signal. [Cited by 3-4-4-a-1]
- III. Team A is leading 24-21 with less than one minute in the game and the game clock running. With the ball ready for play on third and seven at the B-35, tackle B55 jumps across the neutral zone and contacts A77. The officials shut the play down with the game clock showing 0:38. Team B is out of timeouts. **RULING:** Offside against Team B. Five-yard penalty and a 10-second runoff from the game clock. The game clock is set at 0:28. Third and two at the B-30. The clock starts on the referee's signal. [Cited by 3-4-4-a-1]
- IV. Fourth quarter with the game clock running. Second and five at the B-20. Tackle B77 is in the neutral zone at the snap, but does not make contact. QB A12 rolls out to pass, runs to the B-17 and throws a forward pass, which falls incomplete. The game clock reads 0:15. **RULING:** Team A illegal forward pass and Team B offside. Offsetting fouls. No 10-second runoff. Second and five at the B-20. The game clock remains at 15 seconds and starts on the snap. [Cited by 3-4-6-d]
- V. Second and 10 at the B-30 with the game clock running. Team A trails in the score. Guard A66 in a three-point stance misses the snap count and lurches forward, committing a false start. B77 then commits a dead-ball personal foul or a dead-ball foul for unsportsmanlike conduct. The game clock is stopped with 8 seconds remaining in the game. This occurs (a) in the fourth quarter; (b) in the second quarter. **RULING:** (a) The game is over because Team B will accept the 10-second runoff associated with the false start. Thus the penalty for B77's dead-ball foul is not enforced. (b) The half is over because Team B will

accept the 10-second runoff associated with the false start. The penalty for the Team B dead-ball foul carries over to the second half. Due to the 10-second runoff, by interpretation the Team B dead-ball foul effectively occurs after the half has ended and the penalty is thus carried over. In either (a) or (b) Team A may avoid the 10-second runoff by using an available charged timeout. In that case the penalty for the foul by B77 would be enforced, giving Team A first and 10 at the B-20 after enforcement of both penalties. If this is B77's second unsportsmanlike conduct foul, they are disqualified. [Cited by 3-4-4-a-1]

- VI. In the second quarter with the score tied, the game clock reads 0:45 at the snap. During the play, A55 loses their helmet. Right tackle A77 is flagged for holding. The ball carrier is tackled inbounds short of the line to gain. **RULING:** A55 must leave the game for one play. There is no option for a 10-second runoff, because at the end of the play the clock is stopped both for the helmet off and to administer the holding penalty. The play clock is set to 25 seconds and the game clock starts on the referee's signal or snap at the option of the offended team. (Rule 3-3-10) [Cited by 3-3-10-b-2]
- VII. Second and seven at the A-5 late in the second quarter. Quarterback A11 drops back to pass and is scrambling in their end zone as they try to find an open receiver. About to be tackled in the end zone, A11 throws the ball forward to the ground in an area where there are no eligible receivers. The referee throws a flag for intentional grounding. When the ball is dead the game clock shows 0:18. Team B accepts the penalty. **RULING:** The penalty results in a safety, and Team A will free kick at the A-20. Team B has the option for a 10-second runoff. If Team B accepts the runoff, the game clock is set at 0:08 and starts on the referee's signal. If Team B declines the runoff, the game clock remains at 0:18 and starts when the kicked ball is legally touched in the field of play. [Cited by 3-4-4-a-2]

10-second Runoff Summary

ARTICLE 5. The following is a summary of when the 10-second runoff process is in effect:

- a. Injury timeout (Rule 3-3-6-f).
- b. Helmet comes off timeout (Rule 3-3-10-b-2).
- c. Foul (Rule 3-4-4).
- d. Video review (Rule 12-2-4-c-3).

10-second Runoff from Game Clock — Common Procedures

ARTICLE 6. a. The 10-second rule only applies if the game clock is running when the event occurs and the event causes the game clock to stop (**A.R. 3-3-6:XVIII, XX**).

- b. If there is a 10-second runoff, the game clock will start on the referee's signal. If there is no 10-second runoff, the game clock will start on the snap.

NOTE: This rule supersedes Rule 3-3-2-f (snap supersedes referee's signal) but does not supersede Rule 3-3-2-g (running clock). (**A.R. 3-3-2:VIII**)

- c. If the team that caused the event has a team timeout remaining they may avoid the 10-second runoff by using a team timeout. In this case the game clock will start on the snap after the timeout.
- d. The 10-second runoff does not apply when both teams are equally responsible for stopping the clock (e.g. offsetting fouls, or injured or helmet-off players from both teams) (**A.R. 3-4-4:IV**) (**A.R. 3-3-6:XIX**) (**A.R. 3-4-3:VII**).

SECTION 5. Substitutions

Substitution Procedures

ARTICLE 1. Any number of legal substitutes for either team may enter the game between periods, after a score or try, or during the interval between downs only for the purpose of replacing a player(s) or filling a player vacancy(ies).

Legal Substitutions

ARTICLE 2. A legal substitute may replace a player or fill a player vacancy provided none of the following restrictions are violated:

- a. No incoming substitute shall enter the field of play or an end zone while the ball is in play.

- b. No player, in excess of 11, shall leave the field of play or an end zone while the ball is in play.
(A.R. 3-5-2:I)

PENALTY – [a-b] Live-ball foul. Five yards from the previous spot [S22: SUB].

- c. 1. An incoming legal substitute must enter the field of play directly from their team area, and a substitute, player or departing player must depart at the sideline nearest their team area and proceed to their team area.
2. A departing player must immediately leave the field of play, including the end zones. A departing player who leaves the huddle or their position within three seconds, after a substitute becomes a player, is considered to have left immediately.
- d. Substitutes who become players (Rule 2-27-9) must remain in the game for at least one play and replaced players must remain out of the game for at least one play, except during the interval between periods, after a score, or when a timeout is charged to a team or to the referee with the exception of a live ball out of bounds or an incomplete forward pass (A.R. 3-5-2:III, IV and VI).

PENALTY – [c-d] Dead-ball foul. Five yards from the succeeding spot [S22: SUB].

- e. When Team A sends in its substitutes, the officials will not allow the ball to be snapped until Team B has been given an opportunity to substitute. While in the process of substitution or simulated substitution, Team A is prohibited from rushing quickly to the line of scrimmage with the obvious attempt of creating a defensive disadvantage. If the ball is ready for play, the game officials will not permit the ball to be snapped until Team B has placed substitutes in position and replaced players have left the field of play. Team B must react promptly with its substitutes (A.R. 3-5-2:II, V, VII-IX). Team B's privilege to delay the snap ends if:
1. It does not commence its substitution process within 3 seconds of Team A's latest substitute entering the field of play.
 2. Any replaced player is not leaving the field of play quickly.
 3. Any substitute is not entering the field of play quickly.

PENALTY – [e] (First offence) Dead-ball foul. Delay of game on Team B for not completing its substitutions promptly, or delay of game on Team A for causing the play clock to expire. Five yards from the succeeding spot [S21: DOG]. The referee will then notify the head coach that any further use of this tactic will result in an unsportsmanlike conduct foul.

(Second and subsequent infractions) Dead-ball foul, team unsportsmanlike conduct. An official will sound their whistle immediately. 15 yards from the succeeding spot. [S27: UC-UNS].

Approved Ruling 3-5-2

- I. Any player(s), in excess of 11, obviously is withdrawing but has not reached a boundary line when the ball is put in play and they do not interfere with play or players. **RULING:** Live-ball foul. Penalty — Five yards from the previous spot. [Cited by 3-5-2-b]
- II. After a change of team possession or any timeout, the ball is declared ready for play. When Team A has completed its offensive formation, Team B must promptly position its personnel. Team B will be allowed time to complete substitutions. **RULING:** Either team is subject to a delay-of-game foul – Team B for not completing its substitutions promptly (Rule 3-4-2-b-3) or Team A for causing the 25 second clock to expire. Penalty — Five yards from the succeeding spot. [Cited by 3-5-2-e]
- III. On third down (no change of team possession), ball carrier A27 goes out of bounds or Team A's legal forward pass falls incomplete. During this interval between downs, there is no other referee's timeout. Before the fourth down snap, substitute B75 enters the game and then departs without remaining in the game for one play. **RULING:** Dead-ball foul. Penalty — Five yards from the succeeding spot. [Cited by 3-5-2-d]
- IV. Team A has 11 players in the huddle. A81 mistakenly thinks they have been replaced and runs to their team area. They are immediately sent back onto the field and assumes a position on the line of scrimmage near their sideline. The entire team has been stationary for one second before the snap and there has not been a referee's timeout. **RULING:** Dead-ball foul. The player loses their status as a participant when they enter the team area while the ball is dead, and then must adhere to substitution

- rules. Penalty — Five yards from the succeeding spot, or 15 yards from the succeeding spot if this is judged to be a violation of Rule 9-2-2-b. (Rules 3-5-2-d and 9-2-2-b). [Cited by 3-5-2-d, 9-2-2-b]
- V. After the ball is ready for play and the umpire (or centre judge) is in their regular position, Team A quickly replaces some players with substitutes, gets set for the required one second and snaps the ball. The umpire (or centre judge) is attempting to get to the ball to allow the defense to match up, but they are unable to prevent the snap. **RULING:** The play is shut down, the game clock is stopped and the defense is allowed to substitute in response to Team A's late substitutions. **Team A will be penalised 5 yards for delay of game. The play clock is set to 25 seconds and starts on the ready-for-play signal. The game clock starts on the ready-for-play signal or the snap, depending on its condition when play was stopped. (see also A.R. 9-2-3:I).** [Cited by 3-5-2-e]
- VI. After a down that resulted in first and 10 at the B-40, eleven players of Team A, which runs a no-huddle offense, move to their various positions to set for the next play. The ball is ready for play when A22 runs onto the field from their team area, and after they pause at the top of the numbers, they or the coaching staff apparently realise that they are the 12th player. A22 then turns and runs back to their team area. The ball has not been snapped. **RULING:** Dead-ball foul for a substitution infraction. By interpretation A22 has become a player by entering their team's "effective huddle" and thus must remain in the game for at least one play. Five-yard penalty. Team A will have first and 15 at the B-45. (Rule 2-27-9-b) [Cited by 2-27-9-b, 3-5-2-d]
- VII. Late in the first half Team A is out of timeouts. A pass play on third down ends inbounds at the B-25 short of the line to gain with the game clock showing 0:10. Facing fourth down and three, Team A immediately hurries its field goal team onto the field. **RULING:** Team B should reasonably expect that Team A will attempt a field goal in this situation and should have its field-goal defense unit ready. The umpire (or centre judge) will not stand over the ball, as there should be no issue of the defense being uncertain about the next play. [Cited by 3-5-2-e]
- VIII. Late in the first half Team A is out of timeouts. A pass play on third down ends inbounds at the B-25 short of the line to gain with the game clock showing 0:30. Facing fourth down and three, Team A gives no indication as to its next play until the game clock reads 0:10. They then rush their field goal unit onto the field, and Team B then hurries to respond. **RULING:** The referee starts the substitution mechanics process and the umpire (or centre judge) moves to the ball to prevent the snap. The umpire (or centre judge) will step away when the referee determines that the defense has had adequate time to complete its substitution. If the game clock reads 0:00 before the ball is snapped after the umpire (or centre judge) steps away, the half has ended. [Cited by 3-5-2-e]
- IX. 1/10 @ A-25. Late in the 1st quarter, ball carrier A21 circles right end toward his team area and is hit by B54 at the A-30. A21 continues to drive forward and lands with his body down at the A-34 (a) just inbounds; (b) out of bounds in the white; (c) out of bounds in or near the team area having crossed the sideline at the A-34. There are no other substitutions for Team A. **RULING:** Team A will have 2/1 @ A-34. In (a), the game clock will not stop, and the play clock will be set to 40 and started within 1 second from when the ball is declared dead. Team A may snap the ball when the ball is ready for play. In (b), the game clock will be stopped, and will be restarted on the referee's signal. The play clock will be set to 40 and will start within 1 second from when the ball is declared dead. In (c), if the referee considers that the snapper is at, near or moving towards their position at the line of scrimmage, they will give the matching substitutes signal signifying substitution mechanics are in place and Team B will be given the opportunity to substitute. When Team A players go into or near their team area after the play, the referee will consider the substitution mechanics process. [Cited by 3-5-2-e]

More than eleven players on the field

ARTICLE 3. a. Team A may not break the huddle with more than 11 players nor keep more than 11 players in the huddle or in a formation for more than three seconds. Officials shall stop the action whether or not the ball has been snapped.

PENALTY – Dead-ball foul. Five yards at the succeeding spot. [S22: SUB]

b. Team B is allowed to briefly retain more than 11 players on the field to anticipate the offensive formation, but it may not have more than 11 players on the field when the ball is snapped. The infraction is treated as a live-ball foul. (A.R. 3-5-3:I-VII)

PENALTY – Live-ball foul. Five yards at the previous spot. [S22: SUB]

After the two-minute warning in either half, if Team B commits a substitution foul and 12 or more players are on the field and participate in a down, officials will penalise Team B for the

foul and, at the option of Team A, reset the game clock back to the time displayed at the snap. The game clock will then restart on the next snap. If the 12th defender was attempting to exit but was still on the field at the snap and had no influence on the play, then the normal substitution penalty would be enforced with no clock adjustment (A.R. 3-5-3:VIII-X).

- c. When Team A is in formation, Team B must not have more than 11 players in its formation. If the play clock is at :00 (or at :05 or less and Team A calls a timeout) and Team B has more than 11 players on the field, it is a foul against Team B.

PENALTY – Dead-ball foul. Five yards at the succeeding spot. [S22: SUB]

Approved Ruling 3-5-3

- I. A33, an incoming substitute, enters the huddle or assumes a position in a formation and (a) after approximately two seconds, A34 leaves the huddle and departs the field of play at their sideline, or (b) after approximately four seconds, A34 leaves the huddle and departs the field of play at their sideline. **RULING:** (a) Legal. (b) Foul. (*Note:* A departing player who leaves the huddle or their position within three seconds is considered to have left immediately.) [Cited by 3-5-3-b]
- II. 3/5 @ B-35. Team B has 12 players in the formation, and no Team B player is attempting to leave the field while the ball is ready for play. Team A snaps the ball and the run by A44 gains 3 yards. **RULING:** Live-ball foul, Team A 1/10 @ B-30. [Cited by 3-5-3-b]
- III. Team A has 11 players in its huddle when A27 approaches the huddle (within 10 yards) as it breaks. **RULING:** Dead-ball foul. Penalty — Five yards from the succeeding spot (Rule 2-27-9-a). [Cited by 3-5-3-b]
- IV. 3/5 @ B-35. Team B has 12 players in the formation, and B44 recognises that they are the 12th player and is attempting to leave the field. When the ball is snapped, (a) B44 is on the field but their next stride takes them off the field; or (b) B44 touches out of bounds just before the snap. Team A snaps the ball and the run by A44 gains 3 yards. **RULING:** (a) Live-ball foul by B44. Team A 1/10 @ B-30. (b) No foul by B44, 4/2 @ B-32. To not be counted as the 12th player, B44 must be off the field of play. [Cited by 3-5-3-b]
- V. Team A is in formation to kick a field goal and Team B has 11 players in its formation. Just before the ball is snapped a 12th Team B player runs onto the field. The ball is snapped and the kicker completes their kick. **RULING:** Live-ball foul. Five-yard penalty, previous spot, or Team A may accept the result of the play. [Cited by 3-5-3-b]
- VI. Team A lines up for a two-point try attempt at the B-3. Team B has 11 players in its defensive formation. A 12th Team B player runs onto the field just before or just as the ball is snapped. A22 takes the handoff from the quarterback and (a) is tackled at the one-yard line; or (b) carries the ball into the end zone. **RULING:** Live-ball foul by Team B for illegal substitution. (a) Penalise Team B half the distance to the goal and repeat the try at the B-1½. (b) Team A will decline the penalty on the successful try. [Cited by 3-5-3-b]
- VII. 3/5 @ B-35. Team B has 12 players in the formation, and no Team B player is attempting to leave the field. The ball is ready for play, both teams are in formation and the snap is imminent. Quarterback A12, late in the play clock, is struggling to read the defense and (a) calls timeout; or (b) the play clock expires. **RULING:** When the deep officials count 12 Team B players, both teams are in formation, no Team B player is attempting to leave the field and the snap is imminent, (a) the crew will offer Team A their timeout back and penalise Team B for a substitution foul. Team A 1/10 @ B-30; (b) no foul for delay of game, penalise Team B for a substitution foul. Team A 1/10 @ B-30. [Cited by 3-5-3-b]
- VIII. 1/10 @ B-25. Team A snaps the ball with 12 seconds remaining on the game clock in the 4th quarter. QB A12 can find no receiver open, scrambles outside the tackle box and throws the ball away beyond the neutral zone and the play ends with 6 seconds remaining. The defense participated with 12 players on the field. **RULING:** Foul by Team B for a substitution infraction. The 5-yard penalty will be enforced from the previous spot. At the option of Team A, the game clock will be reset to 0:12 and will start on the snap. [Cited by 3-5-3 Penalty]
- IX. 1/10 @ B-25. Team A snaps the ball with 12 seconds remaining on the game clock in the 4th quarter. QB A12 can find no receiver open, scrambles outside the tackle box and throws the ball away beyond the neutral zone and the play ends with 6 seconds remaining. The defense had 12 players on the field at the snap but B21 was hustling to get off the field and the ball was snapped just before B21 exited the field. **RULING:** Foul by Team B for a substitution infraction. The 5-yard penalty will be enforced from

the previous spot. If B21 had no influence on the play, there would be no clock adjustment. [Cited by 3-5-3 Penalty]

- X. 1/10 @ B-25. Team A snaps the ball with 12 seconds remaining on the game clock in the 4th quarter. QB A12 can find no receiver open, scrambles outside the tackle box and runs for 10 yards and is downed inbounds and the clock is stopped with 6 seconds remaining. The defense participated with 12 players on the field. **RULING:** Foul by Team B for a substitution infraction. There is no requirement to accept the penalty to have the clock reset. The offense may decline the 5-yard penalty and keep the option to reset the game clock to 0:12 and have the game clock start on the next snap. [Cited by 3-5-3 Penalty]

RULE 4

Ball in Play, Dead Ball, Out of Bounds

SECTION 1. Ball in Play – Dead Ball

Dead Ball Becomes Alive

ARTICLE 1. After a dead ball is ready for play, it becomes a live ball when it is legally snapped or legally free-kicked. A ball snapped or free-kicked before it is ready for play remains dead.

(A.R. 2-16-4:I) (A.R. 4-1-4:I and II) (A.R. 7-1-3:IV) (A.R. 7-1-5:I and II)

Live Ball Becomes Dead

ARTICLE 2. a. A live ball becomes a dead ball as provided in the rules, or when an official sounds their whistle (even though inadvertently), or otherwise signals the ball dead. (A.R. 4-2-1:II)

(A.R. 4-2-4:I)

b. If an official sounds their whistle inadvertently or otherwise signals the ball dead during a down (Rules 4-1-3-k, 4-1-3-m and 4-1-3-n) (A.R. 4-1-2:I-VI):

1. When the ball is in player possession, the team in possession may elect to put the ball in play where declared dead or repeat the down.
2. When the ball is loose from a fumble, backward pass or illegal pass, the team in possession may elect to put the ball in play where possession was lost or repeat the down.

Exceptions:

- (1) Rule 12.
- (2) If the ball goes out of bounds in the immediate continuing action after the inadvertent whistle, then the ball belongs to the fumbling/passing team according to Rule 7-2-4.
- (3) If there is a clear catch, recovery or interception of a loose ball in the immediate continuing action after the inadvertent whistle, then the ball belongs to the recovering team at the spot of the recovery and any advance is nullified (*Exception: Rule 7-2-2-a Exceptions*).
3. During a legal forward pass or a free or scrimmage kick, then the ball is returned to the previous spot and the down repeated.

Exceptions:

- (1) Rule 12.
- (2) If, in the immediate continuing action after the inadvertent whistle, a legal forward pass is incomplete (Rule 7-3-7), a free kick goes out of bounds (Rule 6-2) or touches the ground on or behind Team B's goal line (Rule 6-1-7), a scrimmage kick goes out of bounds (Rule 6-3-7 or 6-3-8) or touches the ground on or behind Team B's goal line (Rule 6-3-9), then those rules apply as if the inadvertent whistle had not happened.
- (3) If there is a clear catch, recovery or interception of the pass or kick in the immediate continuing action after the inadvertent whistle, then the ball belongs to the recovering team at the spot of the recovery and any advance is nullified.
- (4) If a scrimmage kick crosses the neutral zone and is untouched by Team B beyond the neutral zone, and if Exceptions 1-3 above do not apply and the spot where the kick ends (Rule 2-25-9) is known, the ball is dead and belongs to Team B at the spot where the kick ends. If this spot is beyond the neutral zone, the kick has crossed the neutral zone,

and therefore postscrimmage kick enforcement will apply if the provisions of Rule 10-2-3 hold. On a field goal attempt, a field goal will be scored if the requirements of Rule 8-4-1 are met.

4. After Team B gains possession on the try or during an extra period, then the try is over or the extra-period possession series is ended.
- c. If a foul or violation occurs during a play that ends with an inadvertent whistle, the penalty or violation privilege shall be administered as in any other play situation if not in conflict with other rules. **Any foul that occurs after the inadvertent whistle but during immediate continuing action is treated as a live ball foul. (A.R. 4-1-2:I and II)**
- d. **Immediate continuing action provisions cease if the ball not in player possession (i) touches anything inbounds other than a player, a player's equipment, an official, an official's equipment or the ground; (ii) becomes illegal during play; or (iii) comes into possession of an official.**

Approved Ruling 4-1-2

- I. Team A punts on fourth and 15 at the A-30. B44 is in position to receive the kick. In attempting to catch the ball, B44 muffs it at the B-35. The back judge blows their whistle when it appears that B44 is catching the ball, but it rolls along the ground after B44 muffs it. A88 chases the ball, and in the immediate continuing football action they recover it while grounded at the B-30. B22 is flagged for holding during the kick. **RULING:** Inadvertent whistle. Rule 4-1-2-b-3 Exception 3 applies. Team A declines the penalty and will have the ball at the B-30, first and 10. [Cited by 4-1-2-b, 4-1-2-c]
- II. Team A punts on fourth and 15 at the A-30. B44 is in position to receive the kick. In attempting to catch the ball, B44 muffs it at the B-35. The back judge blows their whistle when it appears that B44 is catching the ball, but it rolls along the ground after B44 muffs it. The ball disappears into a pile of players. B22 is flagged for holding during the kick. **RULING:** Inadvertent whistle. Since there is no clear recovery of the kick, the ball is returned to the previous spot and the 10-yard holding penalty is enforced. Team A retains possession and will have 1st and 10 at the A-40. [Cited by 4-1-2-b, 4-1-2-c]
- III. First and 10 at the B-45. Ball carrier A22 is tackled and is going to the ground, when they fumble. An official sounds their whistle inadvertently. Players on both teams go after the ball, and (a) B66 clearly recovers it while grounded. (b) it is not clear who recovers it. **RULING:** Inadvertent whistle. Rule 4-1-2-b-2 Exception 3 applies. (a) If it is determined that A22 lost control of the ball before they were down, then the ball belongs to Team B at the spot of the recovery by B66. (b) In the event that it cannot be determined which team recovers the ball, Team A retains possession at the dead-ball spot or may elect to repeat the down. [Cited by 4-1-2-b]
- IV. Team A punts on fourth and 15 at the A-30. B44 is in position to receive the kick. In attempting to catch the ball, B44 muffs it at the B-35. The back judge blows their whistle when it appears that B44 is catching the ball, but it rolls along the ground after B44 muffs it. A88 chases the ball, and in the immediate continuing football action they recover it while grounded at the B-30. **RULING:** Inadvertent whistle. Rule 4-1-2-b-3 Exception 3 applies. Team A will have the ball at the B-30, first and 10. [Cited by 4-1-2-b]
- V. Team A punts on fourth and 15 at the A-30. B44 is in position to receive the kick. In attempting to catch the ball, B44 muffs it at the B-35. The back judge blows their whistle when it appears that B44 is catching the ball, but it rolls along the ground after B44 muffs it. The ball disappears into a pile of players. **RULING:** Inadvertent whistle. Since there is no clear recovery of the kick, the ruling of the dead ball stands. Repeat the down at the previous spot. [Cited by 4-1-2-b]
- VI. What is meant by "otherwise signals the ball dead" in Rule 4-1-2-b? **RULING:** It means an official giving one of the following signals: stop the clock (S3); touchdown/field goal (S5); safety (S6); dead ball (S7); incomplete pass (S10). Such a signal interrupted before the official's arms are held or moved in the correct position is not regarded as a signal. Any verbal statement (e.g. saying "the ball is dead" or similar) is also not regarded as a signal unless preceded by a whistle. [Cited by 4-1-2-b]

Ball Declared Dead

ARTICLE 3. A live ball becomes dead and an official shall sound their whistle or declare it dead:

- a. When it goes out of bounds other than a kick that scores a field goal after touching only the uprights or crossbar; when a ball carrier is out of bounds; or when a ball carrier is so held that their forward progress is stopped. When in question, the ball is dead. **(A.R. 4-2-1:II) (A.R. 4-1-3:IX-XI)**

- b. When any part of the ball carrier's body, except their hand or foot, touches the ground or when the ball carrier is tackled or otherwise falls and loses possession of the ball as they contact the ground with any part of their body, except their hand or foot. (**Exception:** The ball remains alive when an offensive player has simulated a kick or at the snap is in position to kick the ball held for a place kick by a teammate. The ball may be kicked, passed, handed or advanced by rule.) (**A.R. 4-1-3:I-II**)
- c. When a touchdown, touchback, safety, field goal, or successful try occurs; or when a free kick or a scrimmage kick that is untouched by Team B beyond the neutral zone touches the ground in Team B's end zone (Rules 6-1-7-a and 6-3-9). (**A.R. 6-3-9:I**)
- d. When, during a try, a dead-ball rule applies (Rule 8-3-2-d-5).
- e. When a player of the kicking team catches or recovers any free kick or a scrimmage kick that has crossed the neutral zone.
- f. When a free kick, scrimmage kick or any other loose ball comes to rest and no player attempts to secure it (**A.R. 4-1-3:VI-VII**).
- g. When a scrimmage kick or a free kick is caught or recovered by any Team B player after a valid or invalid fair catch signal by a Team B player; or when an invalid fair catch signal is made after a catch or recovery by Team B (Rules 2-8-1, 2-8-2 and 2-8-3).
- h. When there is a return kick or a scrimmage kick is made beyond the neutral zone.
- i. When a forward pass is ruled incomplete.
- j. When, before a change of team possession on fourth down or a try, a Team A fumble is caught or recovered by a Team A player other than the fumbler (Rules 7-2-2-a, 7-2-2-b and 8-3-2-d-5).
- k. When a live ball not in player possession touches anything inbounds other than a player, a player's equipment, an official, an official's equipment or the ground (inadvertent whistle provisions apply).
- l. When there is a simultaneous catch or recovery of a live ball.
- m. When the ball becomes illegal while in play (inadvertent whistle provisions apply).
- n. When a live ball comes into possession of an official (inadvertent whistle provisions apply).
- o. When a ball carrier simulates placing their knee on the ground.
- p. When an airborne pass receiver from either team is held so that they are prevented from immediately returning to the ground. (**A.R. 7-3-6:III**)
- q. When a ball carrier's helmet comes completely off.
- r. When a ball carrier obviously begins, simulates or fakes a feet-first slide. (**A.R. 4-1-3:III-IV**)
- s. When all players in the vicinity of the ball stop playing and/or believe it to be dead (**A.R. 4-1-3:V, VIII-IX**).

Approved Ruling 4-1-3

- I. While A1 is holding the ball for a place kick, Team B plays the ball by (a) recovering a loose ball, (b) snatching it from A1 or (c) batting it from their hands. **RULING:** (a), (b) and (c) The ball remains alive. In (c), the batting by Team B is legal and results in a fumble. [Cited by 2-11-1, 4-1-3-b]
- II. Team A is in formation to attempt a field goal. At the snap A22 is in position to execute a right-footed place kick and A33 is in position as the holder. The snap goes to A33 who has a knee on the ground. Just after the snap A22 breaks to their left and toward the neutral zone, and A33, while still on their knee, flips a forward pass to A22 who carries the ball beyond the line to gain before they are tackled. **RULING:** Legal play, because at the snap A22 was in position to attempt a place kick. First and 10 for Team A. [Cited by 4-1-3-b]
- III. Third and 10 at the A-35. Quarterback A11 sweeps to their right and goes into a feet-first slide to give themselves up. When they start their slide, the forward-most point of the ball is at the A-44, and when they come to a stop the forward-most point of the ball is at the A-46. **RULING:** Fourth and one at the A-44. The ball is dead at its forward-most point when they start their slide. [Cited by 4-1-3-r]

- IV. 3/10 @ B-40. QB A12 takes the snap and rolls out to the right. Finding no receiver open, A12 turns up field and runs. After making the line to gain, A12 breaks stride as if they are going to slide feet first at the B-27, stays upright and runs for a touchdown. **RULING:** The live ball becomes dead at the point where A12 simulates or fakes as if they will begin a feet-first slide. An official shall sound their whistle and declare the ball dead. Team A will have 1/10 @ B-27. A fake slide is not reviewable under Rule 12-1-2. [Cited by 4-1-3-r]
- V. B23 catches a kick but does not advance. No Team A player attempts to tackle B23. (i) B23 places the ball on the ground and walks away from it, (ii) tosses the ball to an official, or (iii) pauses for a few seconds then advances the ball. **RULING:** The ball is dead when it is clear B23 is not going to advance it or it is clear Team A believe them to have given up (Rule 4-1-3-s). In (iii), a foul for delay of game might be warranted (Rule 3-4-2-b-1). [Cited by 4-1-3-s]
- VI. Team A punts the ball downfield and no Team B player attempts to catch or recover it. A40 touches the ball and stops it rolling but does not secure possession of it. A40 walks away from the ball and no Team B player moves to recover the ball. **RULING:** The ball is dead when it is clear that players in the vicinity of the ball show no interest in recovering it (Rule 4-1-3-f). [Cited by 4-1-3-f]
- VII. Team A punts the ball downfield and no Team B player attempts to catch or recover it. A40 touches the ball and stops it rolling but does not secure possession of it. A40 walks away from the ball and no nearby Team B player moves to recover the ball. After 2 seconds, B33 shouts "it's still live" and starts running towards the ball, picks it up and advances with it. **RULING:** The ball is dead when it is clear that players in the vicinity of the ball show no interest in recovering it. B33's action occurred after the ball became dead (Rule 4-1-3-f). [Cited by 4-1-3-f]
- VIII. 4th and 10 on Team B's 15-yard line. Team A attempts a field goal but the kick is partially blocked. The ball rolls to a stop at Team B's 2-yard line where B15 picks it up but does not advance. A24 stops next to B15 but does not tackle them. After a pause, B15 hands the ball to A24 who advances into the end zone. **RULING:** The ball is dead when it is clear that B15 is not going to advance the ball. Handing the ball to an opponent shows that B15 believes the ball to be dead. Not tackling an opponent shows that A24 believes the ball to be dead. Team B's ball 1st and 10 at their 2-yard line (Rules 4-1-3-s and 5-1-1-e-1). [Cited by 4-1-3-s]
- IX. 4th and 10 on Team B's 40-yard line. Team A's punt is blocked and does not cross the neutral zone. A84 recovers the ball behind the neutral zone at Team A's 45-yard line, but does not advance. Team B players start leaving the field. **RULING:** The ball is dead when it is clear that A84 is not going to advance it. Team B's ball 1st and 10 at Team A's 45-yard line (Rules 4-1-3-s and 5-1-1-c). [Cited by 4-1-3-a, 4-1-3-s]
- X. A2's place kick is driven low and strikes the crossbar. The ball bounces off the crossbar directly onto the helmet of B80 who is standing in the end zone. The ball ricochets off B80's helmet over the crossbar and between the posts. **RULING:** No score. The ball is dead when it hits the crossbar. By interpretation, if it continues on through the uprights after striking the crossbar, it is good, but the attempt in this play is no good because it touches something else before going through the goal. [Cited by 4-1-3-a]
- XI. A2's place kick is driven low and strikes the crossbar. The ball bounces off the crossbar, bounces directly up before hitting the crossbar again and then going through the uprights. **RULING:** Field goal. As long as the ball does not touch anything other than the uprights or crossbar before going through, the score is good. [Cited by 4-1-3-a]

Ball Ready for Play

ARTICLE 4. No player shall put the ball in play before it is ready for play. (A.R. 4-1-4:I and II)

PENALTY – Dead-ball foul. Five yards from the succeeding spot [S7 and S19: IPR].

Approved Ruling 4-1-4

- I. Snapper A1 snaps the ball before the ball is made ready for play. A2 muffs the snap and B1 recovers the ball. **RULING:** Dead-ball foul, Team A illegal procedure. Penalty — Five-yards from the succeeding spot, Team A's ball. The ball does not become alive, and all action should be stopped immediately by the game officials. [Cited by 2-2-4-b, 4-1-1, 4-1-4, 7-1-1-b]
- II. Kicker A1 kicks off before the referee has declared the ball ready for play. **RULING:** Dead-ball foul. Penalty — Five yards from the succeeding spot. The ball does not become alive, and all action should be stopped immediately by the game officials. [Cited by 2-2-4-b, 4-1-1, 4-1-4, 7-1-1-b]

Play-Clock Count

ARTICLE 5. The ball shall be put in play within 40 or 25 seconds after it is made ready for play (Rule 3-2-4), unless, during that interval, play is suspended. If play is suspended, the play-clock count will start again.

PENALTY – Dead-ball foul for delay of game. Five yards from the succeeding spot [S21: DOG].

SECTION 2. Out of Bounds

Player Out of Bounds

ARTICLE 1. a. A player is out of bounds when any part of their person touches anything, other than another player or game official, on or outside a boundary line (Rule 2-27-15). (**A.R. 4-2-1:I and II**)

- b. An out-of-bounds player who becomes airborne remains out of bounds until they touch the ground in bounds without simultaneously being out of bounds.
- c. A player who touches a pylon is out of bounds.

Approved Ruling 4-2-1

- I. An inbounds ball carrier bumps into or is touched by a player or game official on the sideline. **RULING:** The ball carrier is not out of bounds. [Cited by 4-2-1-a]
- II. Ball carrier A1 is running inbounds near the sideline when they are contacted by a squad member of Team B, who is on the sideline. **RULING:** Rule 4-2-1 states a player is out of bounds when any part of their person touches anything other than a player or an official. Penalty — 15 yards or other unfair-action game administration-interference penalties (Rules 9-2-3 and 9-2-5). [Cited by 4-1-2-a, 4-1-3-a, 4-2-1-a, 9-2-3-c]
- III. Team A executes an onside kick at the A-35. A33 is running near the sideline and steps out of bounds at the A-45. At the A-47 they leap and bat the ball forward, and it rolls out of bounds at the A-49. **RULING:** Foul against Team A for free kick out of bounds at the A-47. Airborne A33 is out of bounds when they touch the ball because they have not established themselves in bounds after going out of bounds. Not a foul for batting the ball forward because the ball is dead as soon as A33 touches it (Rule 4-2-3-a). [Cited by 6-2-1]

Held Ball Out of Bounds

ARTICLE 2. A ball in player possession is out of bounds when either the ball or any part of the ball carrier touches the ground or anything else that is out of bounds, or that is on or outside a boundary line, except another player or game official.

Loose Ball Out of Bounds

- ARTICLE 3. a. A ball not in player control, other than a kick that scores a field goal, is out of bounds when it touches the ground, a player, a game official or anything else that is out of bounds, or that is on or outside a boundary line (**A.R. 4-2-3:I**).
- b. A ball that touches a pylon is out of bounds behind the goal line.
 - c. If a live ball not in player possession crosses a boundary line and then is declared out of bounds, it is out of bounds at the crossing point.

Approved Ruling 4-2-3

- I. A88 is airborne and secures firm control of A12's forward pass. A88's right foot lands inbounds and they maintain firm control of the ball as they contact the ground. B28, who is standing out of bounds, has their hand touching the ball while A88 is airborne and in firm control of the ball. **RULING:** Completed forward pass. [Cited by 4-2-3-a]

Out of Bounds at Forward Point

ARTICLE 4. a. If a live ball is declared out of bounds and the ball does not cross a boundary line, it is out of bounds at the ball's most forward point when it was declared dead (**A.R. 4-2-4:I**)

(*Exception:* Rule 8-5-1-a, (**A.R. 8-5-1:I**)).

- b. A touchdown is scored if the ball is inbounds and has broken the plane of the goal line (Rule 2-12-2) before or simultaneous with the ball carrier going out of bounds.
- c. A receiver who is in the opponent's end zone and contacting the ground is credited with a completion if they reach over the sideline or end line and catch a legal pass.
- d. The most forward point of the ball when declared out of bounds between the goal lines is the point of forward progress. (**A.R. 8-2-1:I**) (**A.R. 8-5-1:VII**) (*Exception:* When a ball carrier is airborne as they cross the sideline (including a striding runner) forward progress is determined by the position of the ball as it crosses the sideline. (**A.R. 7-2-4:II**) (**A.R. 8-2-1:II-III and V-IX**))

Approved Ruling 4-2-4

- i. A player with one foot out of bounds behind a goal line touches a loose ball in the field of play. **RULING:** Ball is out of bounds and dead at its most forward point in the field of play. If this loose ball was an untouched free kick, it is a free kick out of bounds and a foul. Penalty — Five yards from the previous spot or Team B's ball 30 yards beyond Team A's free kick line. [Cited by 4-1-2-a, 4-2-4-a]

RULE 5

Series of Downs, Line to Gain

SECTION 1. A Series: Started, Broken, Renewed

When to Award Series

- ARTICLE 1. a. A series (Rule 2-24-1) of up to four consecutive scrimmage downs shall be awarded to the team that is next to put the ball in play by a snap after a free kick, touchback, fair catch or change in team possession, or to the offensive team in overtime.
- b. A new series shall be awarded to Team A if it is in legal possession of the ball on or beyond its line to gain when the ball is declared dead.
- c. A new series shall be awarded to Team B if, after fourth down, Team A has failed to earn a first down. **(A.R. 10-1-5:I)**
- d. A new series shall be awarded to Team B if Team A's scrimmage kick goes out of bounds or comes to rest and no player attempts to secure it (**Exception:** Rule 8-5-1-a).
- e. A new series shall be awarded to the team in legal possession when the ball is declared dead:
1. If a change of team possession occurs during the down.
 2. If a scrimmage kick crosses the neutral zone (**Exceptions:** (1) When the down is repeated; (2) Rule 6-3-7).
 3. If an accepted penalty awards the ball to the offended team.
 4. If an accepted penalty mandates a first down.
- f. A new series shall be awarded to Team B whenever Team B, after a scrimmage kick, elects to take the ball at a spot of illegal touching (**Exception:** When the down is repeated) (Rules 6-3-2-a and 6-3-2-b).

Line to Gain

- ARTICLE 2. a. The line to gain for a series shall be established 10 yards in advance of the most forward point of the ball; but if this line is in the opponent's end zone, the goal line becomes the line to gain.
- b. The line to gain is established when the ball is made ready for play before the first down of the new series.

Forward Progress

- ARTICLE 3. a. The most forward point of the ball when declared dead between the end lines shall be the determining point in measuring distance gained or lost by either team during any down (**Exceptions:**
1. Rule 8-5-1. **(A.R. 8-5-1:I)**
 2. When an airborne pass receiver of either team completes a catch inbounds after an opponent has driven the receiver backward and the ball is declared dead at the spot of the catch, the forward progress is where the player gained and maintained firm control of the ball.
- The ball always shall be placed with its length axis parallel to the sideline before measuring (Rule 4-1-3-p) **(A.R. 5-1-3:I, III, IV and VI) (A.R. 7-3-6:V))**.
- b. Questionable distance for a first down should be measured without request. Unnecessary measurements to determine first downs shall not be granted.
- c. No request for a measurement shall be granted after the ball is ready for play.

Approved Ruling 5-1-3

- I. Airborne A88 gains firm control of a legal forward pass one yard within the opponent's end zone. As A88 gains firm control of the ball (a) they are contacted by B21 and A88 first comes to the ground on their knees at the one-yard line and maintains firm control of the ball; (b) A88 is contacted by B21 and A88 first comes to the ground on their feet at the one-yard line and maintains firm control of the ball. **RULING:** Touchdown in both (a) and (b) (Rule 5-1-3-a-2, 8-2-1-b). [Cited by 2-9-2, 5-1-3-a-2, 8-2-1-b]
- II. Receiver A88 runs a route deep into Team B's end zone and circles back toward the QB A12 who throws the ball to A88. As A88 is coming back toward A12, A88 leaps and gains firm control of A12's legal forward pass one yard within Team B's end zone. Airborne A88 is not touched by a Team B player and first comes to the ground maintaining firm control of the ball at the one-yard line landing (a) on their knees; (b) on their feet. After A88 regains their balance, A88 runs and is downed at Team B's five-yard line. **RULING:** Not a touchdown: (a) Team A's ball at the B-1 where the ball is declared dead. (b) Team A's ball at the B-5 where the ball is declared dead. [Cited by 2-9-2, 8-2-1-b]
- III. Airborne A2 receives a legal forward pass at Team A's 35-yard line. As A2 receives the ball, they are contacted by B1 and first come to the ground with the ball at Team A's 33-yard line, where the ball is declared dead. **RULING:** Team A's ball at the 35-yard line. This is the point of forward progress. [Cited by 2-9-2, 5-1-3-a-2]
- IV. A4, with the ball breaking the plane of the 50-yard line while in their possession, dives over the 50-yard line, which is the line to gain for a first down. They are knocked back to Team A's 49-yard line, where any part of their body except their hand or foot touches the ground. **RULING:** First down at forward progress spot (Rule 4-1-3-b). [Cited by 2-9-2, 5-1-3-a-2]
- V. A6 has the ball in their possession and is not controlled by an opponent, as they dive over the 50-yard line, which is the line to gain for a first down, and are forced back across the 50-yard line. A6 continues to run and is tackled at Team A's 49-yard line, where any part of their body, except their hand or foot, strikes the ground. **RULING:** No first down. The point of forward progress is Team A's 49-yard line. [Cited by 2-9-2]
- VI. A5, with the ball breaking the plane of the goal line while in their possession, dives over the goal line and is knocked back to the one-yard line, where any part of A5's body except their hand or foot touches the ground. **RULING:** Touchdown. The ball is dead when it breaks the plane of the goal line in A5's possession. [Cited by 2-9-2, 5-1-3-a-2]

Continuity of Downs Broken

ARTICLE 4. The continuity of a series of scrimmage downs is broken when:

- a. Team possession of the ball changes during a down.
- b. A scrimmage kick crosses the neutral zone.
- c. A kick goes out of bounds.
- d. A kick comes to rest and no player attempts to secure it.
- e. At the end of a down, Team A has earned a first down.
- f. After fourth down, Team A has failed to earn a first down.
- g. An accepted penalty mandates a first down.
- h. There is a score.
- i. A touchback is awarded to either team.
- j. The second period ends.
- k. The fourth period ends.

SECTION 2. Down and Possession After a Penalty**Foul During Free Kick Down**

ARTICLE 1. When a scrimmage down follows the penalty for a foul committed during a free kick down, the down and distance established by that penalty shall be first down with a new line to gain.

Penalty Resulting in New Series

ARTICLE 2. It is a new series with a new line to gain:

- a. After a penalty that leaves the ball in possession of Team A beyond its line to gain.
- b. After a penalty that mandates a first down.

Foul Before Change of Team Possession

ARTICLE 3. a. If a penalty is accepted for a foul that occurs between the goal lines before a change of team possession during a down, the ball belongs to Team A. The down shall be repeated, unless the penalty also involves loss of a down, mandates a first down, or leaves the ball on or beyond the line to gain (**Exceptions:** Rules 8-3-3-b-1, 10-2-3, 10-2-4 and 10-2-5). (**A.R. 10-2-3:I**)

- b. If the penalty involves loss of a down, the down shall count as one of the four in that series.

Approved Ruling 5-2-3

- I. Team A's fourth-down legal forward pass strikes the ground after it touches an originally ineligible receiver who is illegally more than three yards beyond the neutral zone. **RULING:** Foul, ineligible receiver downfield. Penalty — Five yards from the previous spot. Team B's ball, first and 10, if the penalty is declined (Rule 7-3-10). [Cited by 7-3-11]

Foul After Change of Team Possession

ARTICLE 4. If a penalty is accepted for a foul that occurs during a down after a change of team possession, the ball belongs to the team in possession when the foul occurred. The down and distance established by any such penalty shall be first down with a new line to gain (**Exception:** Rule 10-2-5-a).

Penalty Declined

ARTICLE 5. If a penalty is declined, the number of the next down shall be whatever it would have been if the foul had not occurred.

Foul Between Downs

ARTICLE 6. After a distance penalty incurred between downs, the number of the next down shall be the same as that established before the foul occurred, unless enforcement for a foul by Team B leaves the ball on or beyond the line to gain or a penalty mandates a first down (Rule 9-1). (**A.R. 5-2-6:I**) (**A.R. 10-1-5:I-III**)

Approved Ruling 5-2-6

- I. Fourth and two on Team A's 35-yard line. A1 takes the snap and fumbles the ball on Team A's 38-yard line, with the ball going out of bounds on (a) Team A's 40-yard line or (b) Team A's 30-yard line. Immediately after the ball goes out of bounds, Team A commits a personal foul. **RULING:** (a) Team A's ball, first and 10 on Team A's 23-yard line. Start the clock on the ready-for-play signal. (b) Team B's ball, first and 10 on Team A's 15-yard line. Start the clock on the snap. [Cited by 5-2-6]

Foul Between Series

ARTICLE 7. a. The penalty for any dead-ball foul (including live-ball fouls treated as dead-ball fouls) that occurs after a series ends and before the ball is ready for play shall be completed before the line to gain is established.

- b. The penalty for any dead-ball foul that occurs after the ball is ready for play shall be completed after the line to gain is established. (**A.R. 5-2-7:I-V**)

Approved Ruling 5-2-7

- I. Third and four on Team B's 30-yard line. Ball carrier A22 goes out of bounds on the 18-yard line. B88 commits a foul immediately after the ball is out of bounds. **RULING:** First and goal for Team A at the nine-yard line. Clock starts on the ready-for-play signal except in the last two minutes of a half. [Cited by 5-2-7-b]
- II. Fourth and four at the A-16. Ball carrier A22 goes out of bounds at the A-18. A77 commits a foul immediately after the ball is out of bounds. **RULING:** Team B's ball on the nine-yard line. First and goal. Start the clock on the snap. [Cited by 5-2-7-b]

- III. On fourth and five, Team A gains six yards and is awarded a new series. After the ball is made ready for play and before the snap, A55 commits (a) a personal foul, or (b) a false start. **RULING:** (a) First and 25. (b) First and 15. [Cited by 5-2-7-b]
- IV. Team A's ball, third and four from the 50-yard line. After the ball is made ready for play and before the snap, B60 charges across the neutral zone and contacts snapper A50. A61 then fouls B60. A61's foul is a personal foul. **RULING:** Penalise Team B five yards for B60's offside, then penalise Team A 15 yards and reset the line-to-gain indicator to indicate first and 10 from Team A's 40-yard line. [Cited by 5-2-7-b]
- V. After Team A has made a first down, the umpire has placed the ball on the ground at the B-30. The referee waves the umpire away from the ball but before they signal the ball ready for play, snapper A55 snaps the ball. **RULING:** Team A dead-ball foul for delay of game. Five-yard penalty, first and 10 at the B-35. NOTE: This is a foul between series in that it takes place before the ball is declared ready for the next series. Hence it is first and 10, not first and 15 (Rules 4-1-1, 4-1-4). [Cited by 5-2-7-b]
- VI. Ball carrier A22 is tackled hard by B44 at the B-5, resulting in first and goal. After the ball is dead, A22 gets up and punches B44. **RULING:** 15-yard penalty against Team A; A22 is disqualified. After enforcement of the penalty, Team A will have first and 10 at the B-20.

Fouls by Both Teams

ARTICLE 8. If offsetting fouls occur during a down, that down shall be repeated (Rule 10-1-4 Exceptions). (**A.R. 10-1-4:III-VI and VII**)

Rules Decisions Final

ARTICLE 9. No rule decision may be changed after the ball is next legally snapped, legally free kicked or the second or fourth periods have ended (Rules 3-2-1-a, 3-3-4-e-2 and 11-1-1). (**Exception:** The number of a down may be corrected any time within that series of downs or before the ball is legally next put in play after that series.)

RULE 6

Kicks

SECTION 1. Free Kicks

Restraining Lines

ARTICLE 1. For any free kick formation, the kicking team's restraining line shall be the yard line through the most forward point from which the ball shall be kicked, and the receiving team's restraining line shall be the yard line 10 yards beyond that point. Unless relocated by a penalty, the kicking team's restraining line on a kickoff shall be its line 15 yards from the midfield line, and for a free kick after a safety, its 20-yard line.

Free Kick Formation

ARTICLE 2. a. A ball from a free kick formation must be kicked legally and from some point on Team A's restraining line (**Exception:** Rule 6-1-2-c-4) and on or between the hash marks. The referee will declare the ball ready for play when the officials are in position after the kicker has received the ball. (A.R. 2-16-6:I)

After the ready-for-play signal:

1. The ball may only be relocated after a charged team timeout and before a subsequent kick [S19: IFK]. (A.R. 6-1-2:VIII)
2. All players on the kicking team, except the kicker in their kicking motion and the holder for the purposes of holding the ball, must remain behind their restraining line [S18: OFK]. (A.R. 6-1-2:IX)
3. If a Team A player attempts to kick the ball but misses it (intentionally or accidentally), it is a dead-ball foul for illegal procedure [S19: IFK].

PENALTY – Dead-ball foul. Illegal kick. Five yards from the succeeding spot. [S7 and S18 or S19: IFK/OFK]. (A.R. 6-1-2:I)

- b. After the ball has been made ready for play, all players on the kicking team, except the kicker, must be no more than five yards behind their restraining line. A player satisfies this rule when one foot is on or beyond the line five yards behind the restraining line. If one player is more than five yards behind the restraining line and any other player kicks the ball, it is a foul for an illegal formation [S19: IFK]. (A.R. 6-1-2:VII)
- c. When the ball is kicked (A.R. 6-1-2:I-IV):
 1. Each Team A player, except the holder and kicker of a place kick, must be behind the ball [S18: OFK]. (A.R. 6-1-2:V)
 2. All Team A players must be inbounds [S19: IFK].
 3. At least four Team A players must be on each side of the kicker [S19: IFK]. (A.R. 6-1-2:II-IV)
 4. After a safety, when a punt or drop kick is used, the ball may be kicked from behind the kicking team's restraining line. If a yardage penalty for a live-ball foul is enforced from the previous spot, administration is from the 20-yard line, unless the kicking team's restraining line has been relocated by a previous penalty [S18 or appropriate signal: OFK].
 5. All players of Team A must have been between the nine-yard marks after the ready-for-play signal [S19: IFK].

PENALTY – [b-c5] Live-ball foul. Five yards from the previous spot, or five yards from the spot where the subsequent dead ball belongs to Team B, or from the spot where the ball is placed after a touchback [S18 or S19: IFK/OFK] (A.R. 6-1-2:VI).

6. All Team B players must be inbounds [S19: IFK].

7. All Team B players must be behind their restraining line [S18: OFK].

PENALTY – [c6-c7] Live-ball foul. Five yards from the previous spot [S18 or S19: IFK/OFK].

d. After the ball is ready for play and for any reason falls from the tee, Team A shall not kick the ball and an official shall sound their whistle immediately.

Approved Ruling 6-1-2

- I. The ball is kicked while teed illegally, punted on a kickoff or kicked from a spot between the hash mark and the nearer sideline. **RULING:** Illegal kick. Dead-ball foul. Penalty — Five yards from the succeeding spot (2-16-1-b). [Cited by 2-16-1-b, 6-1-2-c, 6-1-2 Penalty]
- II. Kicker A11 places the ball on the tee in the centre of the field for a free kick with four teammates to the left side of the ball and six teammates to the right side of the ball. The ball blows off the tee, and A55 — who was lined up to the left of the ball — holds the ball on the tee for right-footed kicker A11. No other Team A players move. When the ball is kicked by A11, A55 is to the kicker's right. **RULING:** Foul by Team A for illegal formation at the kick. Penalty — Five yards from the previous spot or five yards from the spot where the subsequent dead ball belongs to Team B. [Cited by 6-1-2-c-3, 6-1-2-c]
- III. Free-kicker A11 places the ball on the tee just inside the hash mark line on their right. All of their teammates line up to their left. At the ready for play, four Team A players who were on A11's left run to their right and are in the area to A11's right when A11 kicks the ball. **RULING:** Legal formation. [Cited by 6-1-2-c-3, 6-1-2-c]
- IV. A11 places the ball on the tee for a free kick on the 35-yard line in the centre of the field. A12 lines up near the ball. After the ready for play, A11 starts forward as if to kick the ball, and A12 suddenly crosses in front of them and kicks the ball. When the ball is kicked, A11 is directly behind the ball with three teammates on one side of the ball. A12 plants their non-kicking foot on the same side of the ball as their three teammates. **RULING:** Foul by Team A for illegal formation. Penalty — five yards from the previous spot and re-kick if Team B chooses; or five yards from the spot where the subsequent dead ball belongs to Team B. [Cited by 6-1-2-c-3, 6-1-2-c]
- V. Team A is offside during its free kick. B27 has their knee on the ground when they recover the kick. **RULING:** Foul by Team A for offside. The ball is dead at the spot of the recovery. Penalty — Team B may choose five yards from the previous spot and another free kick, or five yards from the dead-ball spot with a first and 10. B27's recovery started a running play that ended immediately. This scenario also would have been valid if B27 had completed a fair catch. [Cited by 6-1-2-c-1]
- VI. Team A is offside on its free kick and B17 catches the ball at their 15-yard line. B17 returns the ball to their 45-yard line where they fumble. A67 recovers at the B-47 and runs to the B-35 where they fumble, with B20 recovering while downed at their 33-yard line. **RULING:** Foul by Team A for offside. Team B may choose to have Team A kick again after a five-yard penalty from the previous spot, or Team B may have a first and 10 at its 38-yard line. [Cited by 6-1-2 Penalty]
- VII. Team A is in its formation to kick off at the A-35. Two players, A33 and A66, are positioned in a four-point stance with their feet on the A-29 and their hands on the A-31. The untouched kick hits the ground in Team B's end zone and is declared dead. **RULING:** Touchback. Team A foul, illegal formation. Team B has two options for accepting the penalty: Put the ball in play at the B-30, after a five-yard penalty at the spot (the B-25) where the dead ball belongs to them; or have Team A re-kick at the A-30 (Rule 6-1-8). [Cited by 6-1-2-b]
- VIII. Late in the game with the score tied, Team A lines up to free kick from the A-35. Kicker A10 places the ball down at the right hash for an apparent onside kick. After the referee's ready-for-play signal, A10 approaches the ball and then picks up the ball, runs to the left hash at the A-35, places the ball down and quickly kicks the ball. **RULING:** By interpretation, once the ball's position between the hash marks has been selected by Team A and after the ready-for-play, the ball may be relocated only after a charged team timeout and before any re-kick. Dead-ball foul. **Illegal formation.** Five-yard penalty from the succeeding spot. [Cited by 6-1-2-a-1]
- IX. Free kick @ A-35. Late in the game with the kicking team trailing by 2 points, they set up for an on-side kick. The kicking team has 6 players to the left of the kicker and 4 to the right of the kicker. Kicker A90 is lined up to kick the ball to the left side of the formation and as A90 approaches the ball they abruptly stop

but the kicking team players to the left of the kicker continue and cross their restraining line. These players stop and then retreat back across their restraining line and A90 quickly turns and kicks the ball back to the right side of the formation with all players for Team A now back behind their restraining line.

RULING: Dead-ball foul, five-yard penalty from the succeeding spot. By Rule 6-1-2-a-2, each Team A player, except the kicker and potential holder, must be behind the ball when the ball is kicked. If they are beyond the ball and the ball is kicked - this is a live ball foul for offside on a kickoff. If a Team A player goes beyond their restraining line after the ball is ready for play and then returns back across their restraining line before the ball is kicked - this is a dead-ball foul for offside by the kicking team. This interpretation does not impact situations when the ball falls from the tee (Rule 6-1-2-d). When the ball falls from the tee, the official shall sound their whistle immediately and reset both teams. [Cited by 6-1-2-a-2]

x

Touching and Recovery of a Free Kick; Illegal Touching

ARTICLE 3. a. No Team A player may touch a free-kicked ball until after:

1. It touches a Team B player (**Exception:** Rules 6-1-4 and 6-5-1-b);
 2. It breaks the plane of and remains beyond Team B's restraining line (**Exception:** Rule 6-4-1) (**A.R. 2-12-5:I**); or
 3. It touches any player, the ground, an official or anything else beyond Team B's restraining line. Thereafter, all players of Team A become eligible to touch, recover or catch the kick.
- b. Any other touching by Team A is *illegal touching*, a violation that, when the ball becomes dead, gives the receiving team the privilege of taking the ball at the spot of the violation.
- c. If there is an accepted penalty for a live-ball foul by either team, or if there are offsetting fouls, the illegal touching privilege is cancelled. (**A.R. 6-1-3:I**)
- d. Illegal touching in Team A's end zone is ignored.

Approved Ruling 6-1-3

- I. A33 illegally touches a free kick; then they or A44 illegally recover the kick. **RULING:** Illegal touching by both A33 and A44. Unless there is an accepted penalty or offsetting fouls, Team B may elect to take the ball at any spot of the illegal touching. [Cited by 6-1-3-c]
- II. Team A executes an onside free kick at the A-35. The untouched kick is at the A-43 when A55 blocks B44 above the waist in the front at the A-46. A28 muffs the ball at the A-44, and after it rolls to the A-46, A88 blocks B22 at the A-42. A20 then recovers the ball at the A-44. **RULING:** The block by A55 is a foul and the touching by A28 is illegal, because Team A is not eligible to touch the ball since it has not gone 10 yards nor has it been touched by Team B. The block by A88 is legal because it occurs after the ball has gone 10 yards. Team A is in legal possession of the ball when A20 recovers it at the A-44. Team B has two options: Decline the penalty for the illegal block and have the ball at the A-44 via the illegal-touching privilege, or cancel the illegal-touching privilege by having Team A re-kick from the A-30 after the five-yard penalty for the block by A55. Note that the dead-ball spot, the A-44, is not an enforcement spot because the ball does not belong to Team B when the down ends (Rule 6-1-12). [Cited by 6-1-12]

Forced Touching Disregarded

ARTICLE 4. a. A player blocked by an opponent into a free kick is not, while inbounds, deemed to have touched the kick. (**A.R. 2-11-4:I**)

- b. An inbounds player touched by a ball either batted or illegally kicked by an opponent is not deemed to have touched the ball (Rule 2-11-4-c).

Free Kick at Rest

ARTICLE 5. If a free kick comes to rest inbounds and no player attempts to secure it, the ball becomes dead and belongs to the receiving team at the dead-ball spot.

Free Kick Caught or Recovered

- ARTICLE 6. a. If a free kick is caught or recovered by a player of the receiving team, the ball continues in play (*Exceptions:* Rules 4-1-3-g, 6-1-7, 6-5-1 and 6-5-2). If caught or recovered by a player of the kicking team, the ball becomes dead. The ball belongs to the receiving team at the dead-ball spot, unless the kicking team is in legal possession when the ball is declared dead. In the latter case, the ball belongs to the kicking team.
- b. When opposing players, each eligible to touch the ball, simultaneously recover a rolling kick or catch a free kick, the simultaneous possession makes the ball dead.
- c. A kick declared dead in joint possession is awarded to the receiving team.

Ball Dead in End Zone

- ARTICLE 7. a. When a free kick untouched by Team B touches the ground on or behind Team B's goal line, the ball becomes dead and belongs to Team B.
- b. If the result of the free kick is a touchback (Rule 8-6-1) for Team B, they will put the ball in play at their 25-yard line.

Fouls By Kicking Team

ARTICLE 8. Penalties for all fouls by the kicking team during a free kick play other than kick-catch interference (Rule 6-4) may be enforced at the previous spot with the down repeated or at the spot where the subsequent dead ball belongs to Team B, at the option of Team B.

Foul Against Kicker

ARTICLE 9. The kicker of a free kick may not be blocked until they have advanced five yards beyond their restraining line or the kick has touched a player, an official or the ground (Rule 9-1-16-c).
PENALTY – 15 yards from the previous spot [S40: PF-RFK].

Illegal Wedge Formation

- ARTICLE 10. a. A wedge is defined as two or more players aligned shoulder to shoulder within two yards of each other.
- b. Free-kick down only: After the ball has been kicked, it is illegal for two or more members of the receiving team intentionally to form a wedge for the purpose of blocking for the ball carrier. This is a live-ball foul, whether or not there is contact between opponents.

PENALTY – Noncontact foul. 15 yards from the spot of the foul, or 15 yards from the spot where the subsequent dead ball belongs to Team B if this is behind the spot of the foul. 15 yards from the previous spot with the down repeated if the subsequent dead ball belongs to Team A [S27: IWK].

- c. Formation of the wedge is not illegal when the kick is from an obvious outside kick formation.
- d. There is no foul if the play results in a touchback, a foul for free kick out of bounds or a fair catch.

Player Out of Bounds

ARTICLE 11. A Team A player who goes out of bounds during a free kick play may not return inbounds during the down (*Exception:* This does not apply to a Team A player who is blocked out of bounds and attempts to return inbounds immediately).

PENALTY – Live-ball foul. Five yards from the previous spot, or five yards from the spot where the subsequent dead ball belongs to Team B, or from the spot where the ball is placed after a touchback [S19: OBK].

Eligibility to Block

ARTICLE 12. No Team A player may block an opponent until Team A is eligible to touch a free-kicked ball (A.R. 6-1-3:II).

PENALTY – Live-ball foul. Five yards from the previous spot, or five yards from the spot where the subsequent dead ball belongs to Team B, or from the spot where the ball is placed after a touchback [S19: IBK].

SECTION 2. Free Kick Out of Bounds

Kicking Team

ARTICLE 1. If a free kick goes out of bounds between the goal lines untouched by an inbounds player of Team B, it is a foul. (A.R. 6-2-1:I-II) (A.R. 4-2-1:III)

PENALTY – Live-ball foul. Five yards from the previous spot; or five yards from the spot where the subsequent dead ball belongs to Team B; or the receiving team may put the ball in play 30 yards beyond Team A's restraining line at the hash mark [S19: KOB].

Approved Ruling 6-2-1

- I. A kickoff from Team A's 35-yard line goes out of bounds untouched by Team B, and Team A has illegally touched the kick. **RULING:** Team B has four options: it may snap the ball at the spot of the illegal-touching violation; accept a five-yard penalty from the previous spot with Team A kicking from the 30-yard line; put the ball in play at the inbounds spot on its 35-yard line; or put the ball in play at the inbounds spot five yards from where the ball went out of bounds (Rule 6-1-8). [Cited by 6-2-1]
- II. Team A is offside or commits a substitution infraction, and the kickoff from the 35-yard line goes out of bounds after it has been touched by Team B. **RULING:** For either the offside foul or the substitution foul, Team B may elect to have the kick repeated at Team A's 30-yard line, or snap the ball at the inbounds spot five yards from where the ball went out of bounds (Rule 6-1-8). [Cited by 6-2-1]

Receiving Team

ARTICLE 2. If a free kick goes out of bounds between the goal lines, the ball belongs to the receiving team at the hash mark. If a free kick goes out of bounds behind the goal line, the ball belongs to the team defending that goal line. (A.R. 6-2-2:I-IV) (A.R. 6-5-3:II)

Approved Ruling 6-2-2

- I. A free kick from Team A's 35-yard line, untouched by Team B, goes out of bounds between the goal lines, and Team A was offside. **RULING:** Team B has these options: it may accept a five-yard penalty at the previous spot with Team A re-kicking from the 30-yard line; snap the ball at its 35-yard line at the inbounds spot; or snap the ball at the inbounds spot five yards from where the ball went out of bounds. [Cited by 6-2-2]
- II. A free kick from Team A's 35-yard line, untouched by Team B, goes out of bounds between the goal lines, and Team A commits a late hit after the ball went out of bounds. **RULING:** Team B has the choice of Team A kicking again after a five-yard penalty followed by a 15-yard penalty, or putting the ball in play at the inbounds spot either on the 50-yard line or at the inbounds spot 20 yards beyond the spot where the ball went out of bounds. [Cited by 6-2-2]
- III. A free kick in flight strikes a Team B player who is in their end zone and the ball then goes out of bounds at the three-yard line. **RULING:** Team B's ball, first and 10, on the three-yard line at the inbounds spot. [Cited by 6-2-2]
- IV. Free kick at the A-35. B17 leaps from inbounds and is the first player to touch Team A's free kick when they grasp the ball while airborne. They then land out of bounds with the ball in their control. **RULING:** Not a foul for free kick out of bounds. B17 is inbounds when they touch the kick. Team B will have the ball at the yard line where B17 crossed the sideline (Rule 2-27-15). [Cited by 6-2-2]

SECTION 3. Scrimmage Kicks

Behind the Neutral Zone

- ARTICLE 1. a. A scrimmage kick that fails to cross the neutral zone continues in play. All players may catch or recover the ball behind the neutral zone and advance it. **(A.R. 6-3-1:I-III)**
- b. The blocking of a scrimmage kick by an opponent of the kicking team who is not more than three yards beyond the neutral zone is considered to have occurred within or behind that zone (Rule 2-11-5).

Approved Ruling 6-3-1

- I. After a punt travels five yards beyond the neutral zone, B33 touches the ball. It then rebounds behind the zone, where A33 recovers it in the field of play. **RULING:** The ball is dead when recovered and may not be advanced. First down for Team A (Rules 6-3-3 and 6-3-6-a). The game clock starts on the snap following a legal kick down. [Cited by 2-16-7-b] [Cited by 6-3-1-a]
- II. Team A's untouched punt or field goal attempt goes beyond the neutral zone in flight, is blown back by the wind and first touches the ground, a player or an official behind the neutral zone. **RULING:** By rule, the kick is not considered to have crossed the neutral zone until it has touched the ground, a player, an official or anything beyond that zone. Any scrimmage kick may be advanced after catch or recovery by Team B, or after catch or recovery by Team A in or behind the neutral zone if the kick had not crossed the neutral zone (Rule 2-16-7). [Cited by 2-16-7-b, 6-3-1-a]
- III. A1 interferes with B1's opportunity to catch a kick when a scrimmage kick fails to cross the neutral zone. **RULING:** Interference with the opportunity to catch a kick does not apply (Rule 6-4-1), and all players are eligible to touch, recover and advance the ball. Therefore, any player legally may push an opponent in an actual attempt to get at the ball (Rule 9-3-3-c-3); but no player may hold an opponent to prevent their reaching the ball, or in an attempt to permit a teammate to reach it (Rules 9-1-5 Exception 3 and 9-3-5 Exception 3). [Cited by 2-16-7-b] [Cited by 6-3-1-a, 6-4-1-a]
- IV. Team A's punt from behind its own goal line crosses the neutral zone into the field of play, strikes a Team B player and rebounds back across Team A's goal line where A32 recovers. **RULING:** Safety (Rules 6-3-3, 6-3-6-a and 8-5-1-a). [Cited by 2-16-7-b] [Cited by 6-3-6-a, 8-5-1-a]

Beyond the Neutral Zone

- ARTICLE 2. a. No inbounds player of the kicking team shall touch a scrimmage kick that has crossed the neutral zone before it touches an opponent. This is *illegal touching*, a violation that, when the ball becomes dead, gives the receiving team the privilege of taking the ball at the spot of the violation (**Exception:** Rule 6-3-4) **(A.R. 2-12-2:I) (A.R. 6-3-2:I)**.
- b. This privilege is cancelled if there is an accepted penalty for a live-ball foul by either team **(A.R. 6-3-2:I-IV) (A.R. 6-3-11:I-III)**.
- c. The privilege is cancelled if there are offsetting fouls.
- d. Illegal touching in Team A's end zone is ignored. Illegal touching on a try, if accepted, results in no Team A score. Illegal touching in an extra period, if accepted, results in team possession ending.

Approved Ruling 6-3-2

- I. Team A illegally touches its kick; then after Team B has touched it, Team A recovers. **RULING:** Touching by Team A after Team B has touched the kick is legal; and, in order to get the ball, Team B must take it where Team A illegally touched it. Unless illegal touching is also illegal recovery by the kicking team and no fouls are involved, the receiving team may play the ball with the assurance that it may later elect the ball at any spot of illegal touching. [Cited by 6-3-2-a, 6-3-2-b]
- II. During a scrimmage kick, A1 commits a touching violation, after which B1 recovers, advances and fumbles. A2 recovers the fumble and, during the advance, B2 holds, trips or punches. **RULING:** Team A may have the ball where left by the penalty for Team B's foul; but if Team A declines the penalty, Team B will have the ball by electing the touching violation. B2 is disqualified if flagged for fighting. [Cited by 6-3-2-b]
- III. Team A's punt goes beyond the neutral zone and is first touched by A80, then picked up by B40, who runs five yards and fumbles. A20 picks up the fumble and scores. During A20's run, B70 holds. **RULING:** The

score does not count. Five- and 10-yard penalties are not administered on the try or the succeeding kickoff. The penalty for Team B's foul is declined by rule because there is no enforcement spot. The ball belongs to Team B at the spot of illegal touching (Rule 10-2-5-a-2). [Cited by 10-2-5-a-2, 6-3-2-b]

- IV. Team A's punt goes beyond the neutral zone and is first touched by A80, then picked up by B40, who runs five yards and fumbles. B70 holds during B40's run. A20 picks up the fumble and scores. **RULING:** The score does not count. Five- and 10-yard penalties are not administered on the try or the succeeding kickoff. Because the illegal touching provides an enforcement spot, the penalty for Team B's foul may be enforced, per Rule 5-2-4. The ball belongs to Team B, either at the spot of illegal touching if Team A declines the penalty, or at the spot after the enforcement if Team A accepts the penalty (Rules 10-2-2 and 10-2-5-a-2). [Cited by 10-2-5-a-2, 6-3-2-b]

All Become Eligible

ARTICLE 3. When a scrimmage kick that has crossed the neutral zone touches a player of the receiving team who is inbounds, any player may catch or recover the ball (Rule 6-3-1-b) (*Exceptions:* Rules 6-3-4 and 6-5-1-b). (**A.R. 8-4-2:VIII**)

Forced Touching Disregarded

- ARTICLE 4. a. A player blocked by an opponent into a scrimmage kick that has crossed the neutral zone shall not, while inbounds, be deemed to have touched the kick. (**A.R. 6-3-4:I-V**) (**A.R. 2-11-4:I**)
- b. An inbounds player touched by a ball either batted or illegally kicked by an opponent is not deemed to have touched the ball. (Rule 2-11-4-c) (**A.R. 6-3-4:II**).

Approved Ruling 6-3-4

- I. Team A punts from its own 30-yard line. The untouched kick is bouncing at Team B's three-yard line when A3 blocks B1 into the ball, forcing it through the end zone and over the end line. **RULING:** Touchback. Since A3 blocked B1 into the ball, B1 is deemed not to have touched it (Rule 2-11-4). Impetus is from the kick, not from B1's touching (Rule 8-7-1). [Cited by 6-3-4-a]
- II. Team A's long field goal attempt is first touched when A1 bats the rolling ball backward into nearby B1. **RULING:** Illegal touching by A1. Team B is not deemed to have touched the ball (Rules 2-11-4 and 8-4-2-b). [Cited by 6-3-4-a, 6-3-4-b, 8-4-2-b-2]
- III. During a scrimmage kick, the untouched ball is at rest on the Team B three-yard line when B22 blocks A80 into the ball, forcing it into the end zone where it touches the ground. **RULING:** The ball is dead when it touches the ground in the end zone. Touchback — Ignore touching by A80 (Rule 2-11-4). By rule, neither team has touched the kicked ball (Rule 8-6-1-b). [Cited by 6-3-4-a, 8-6-1-b, 8-7-2-a]
- IV. As the punted ball rolls along the ground, punt receiver B22 is blocking A88 to prevent them from downing the ball. The two players are still engaged when the ball bounces into B22's leg. A44 recovers at the B-30. **RULING:** Team A's ball, first and 10 at the B-30. This is not forced touching. Although B22 was in contact with A88 when they touched the ball, this touching was not caused by the contact (Rule 2-11-4). The game clock starts on the snap. [Cited by 6-3-4-a]
- V. As a punt rolls along the ground, A44 blocks B33 into the ball, which bounces away and strikes B48 in the leg. Team A recovers. **RULING:** Team A's ball, first and 10 at the spot of recovery. Although the touching by B33 is forced, that by B48 is not (Rule 2-11-4). B48's touching of the ball allows Team A to recover legally (Rule 6-3-4-a). [Cited by 6-3-4-a]

Catch or Recovery by Receiving Team

ARTICLE 5. If a player of the receiving team catches or recovers a scrimmage kick, the ball continues in play (*Exceptions:* Rules 4-1-3-g, 6-3-9, 6-5-1 and 6-5-2). (**A.R. 8-4-2:V**)

Catch or Recovery by Kicking Team

ARTICLE 6. a. If a player of the kicking team catches or recovers a scrimmage kick that has crossed the neutral zone, the ball becomes dead. (**A.R. 6-3-1:IV**) The ball belongs to the receiving team at the dead-ball spot, unless the kicking team is in legal possession when the ball is declared dead. In the latter case, the ball belongs to the kicking team (*Exception:* Rule 8-4-2-b).

- b. If opposing players who are each eligible to touch the ball simultaneously catch or recover a scrimmage kick, the simultaneous possession makes the ball dead. A kick declared dead in joint possession of opposing players is awarded to the receiving team (Rules 2-4-4 and 4-1-3-1).

Out of Bounds Between Goal Lines or at Rest Inbounds

ARTICLE 7. If a scrimmage kick goes out of bounds between the goal lines, or if it comes to rest inbounds and no player attempts to secure it, the ball becomes dead and belongs to the receiving team at the dead-ball spot (*Exception:* Rule 8-4-2-b). (**A.R. 8-4-2:VII**)

Out of Bounds Behind Goal Line

ARTICLE 8. If a scrimmage kick (other than one that scores a field goal) goes out of bounds behind a goal line, the ball becomes dead and belongs to the team defending that goal line (Rule 8-4-2-b).

Touching Ground On or Behind Goal Line

ARTICLE 9. If a scrimmage kick untouched by Team B beyond the neutral zone touches the ground on or behind Team B's goal line, the ball becomes dead and belongs to Team B (Rule 8-4-2-b). (**A.R. 6-3-9:I-II**)

Approved Ruling 6-3-9

- I. A33 illegally touches a punt and the ball then rolls into Team B's end zone, where Team B recovers and advances the ball into the field of play. **RULING:** The ball is dead when it strikes the ground in the end zone. Team B may choose a touchback or take the ball at the spot of Team A's illegal touching (Rule 4-1-3-c). [Cited by 4-1-3-c, 6-3-9]
- II. A punt goes into Team B's end zone untouched by Team B beyond the neutral zone. Either (a) Team A or (b) Team B commits a personal foul after the ball touches the ground in the end zone. **RULING:** Touchback. Dead-ball foul after the touchback. Team B's ball, first and 10 on the (a) 35-yard line or (b) 10-yard line after enforcement of the penalty at Team B's 20. [Cited by 6-3-9]
- III. A Team B player touches a scrimmage kick in flight in Team B's end zone and Team A downs the ball in the end zone. **RULING:** Team A touchdown (Rules 6-3-3 and 8-2-1-d). [Cited by 8-2-1-d]

Legal and Illegal Kicks

ARTICLE 10. a. A legal scrimmage kick is a punt, drop kick or place kick made according to rule.

b. A return kick is an illegal kick, a live-ball foul that causes the ball to become dead (Rule 2-16-8).

PENALTY – For a return kick (live-ball foul): Five yards from the spot of the foul [S31: KIK].

c. A scrimmage kick made after a ball carrier's entire body and the ball have been beyond the neutral zone is an illegal kick, a live-ball foul that causes the ball to become dead.

PENALTY – For an illegal kick beyond the neutral zone (or when a ball carrier and ball have been beyond the neutral zone) (live-ball foul): Five yards from the previous spot and loss of down [S31 and S9: KIK].

d. No device or material may be used to mark the spot of a scrimmage place kick or elevate the ball. This is a live-ball foul at the snap.

PENALTY – Five yards from the previous spot [S19: KIK].

Loose Behind the Goal Line

ARTICLE 11. If a scrimmage kick untouched by Team B after crossing the neutral zone is batted in Team B's end zone by a player of Team A, it is a violation for illegal touching (Rule 6-3-2). The spot of the violation is Team B's 20-yard line. This is a special case of batting in the end zone and is not a foul. (**A.R. 6-3-11:I-V**) (**A.R. 2-12-2:I**)

Approved Ruling 6-3-11

- I. Team A snaps at the 50-yard line and punts. The kick is untouched beyond the neutral zone when A88 reaches across Team B's goal line and bats the ball back into the field of play, and it rolls out of bounds at the B-4. **RULING:** No foul for batting the ball in the end zone. Illegal touching. The spot of the violation is the B-20. Team B's ball, first and 10 at the B-20. [Cited by 6-3-11, 6-3-2-b, 9-4-1-c]
- II. Team A snaps at the 50-yard line and punts. The kick is untouched beyond the neutral zone when A88 reaches across Team B's goal line and bats the ball back into the field of play. B22 recovers at the B-2 and advances to the B-12 where A66 tackles them by pulling their face mask. **RULING:** No foul for batting in the end zone. Illegal touching. Team B may accept the penalty for the face mask foul, which cancels the illegal touching privilege, and have first and 10 at the B-27. [Cited by 6-3-11, 6-3-2-b]
- III. Team A snaps at the 50-yard line and punts. The kick is untouched beyond the neutral zone when A88 reaches across Team B's goal line and bats the ball back into the field of play. B22 muffs the ball at the B-2 and A43 recovers it at the B-6. While the ball is loose B77 holds A21 at the B-10. **RULING:** Team A may cancel the illegal touching privilege by accepting the holding penalty, which is enforced at the previous spot with an automatic first down. Postscrimmage kick rules do not apply to B77's foul since Team B will not next put the ball in play (Rule 10-2-3). [Cited by 6-3-11, 6-3-2-b]
- IV. Team A snaps at the 50-yard line and punts. During the kick, B77 clips at Team B's 25-yard line. The untouched kick is batted backward by Team A out of bounds from the end zone and goes out of bounds on the two-yard line. **RULING:** No foul for batting the ball in the end zone. Illegal touching. B77's clipping foul is governed by postscrimmage kick rules (Rule 10-2-3). Team A will accept the penalty, which cancels the illegal touching privilege. The penalty is enforced at the postscrimmage kick spot, the B-20, half the distance to the goal line. Team B's ball at the B-10. [Cited by 6-3-11]
- V. Team A snaps at the 50-yard line and punts. The kick is untouched beyond the neutral zone when A88 reaches across Team B's goal line and bats the ball back into the field of play, and it rolls out of bounds at the B-4. During the kick, A55 blocks below the waist. **RULING:** No foul for batting the ball in the end zone. Illegal touching. The spot of the violation is the B-20. Team B may accept the penalty for blocking below the waist, which is enforced either at the previous spot with the down repeated or at the B-4. If Team B declines the penalty, the illegal touching gives the ball to Team B, first and 10 at the B-20. [Cited by 6-3-11]

Out of Bounds Player

ARTICLE 12. No Team A player who goes out of bounds during a scrimmage kick play may return inbounds during the down (**Exception:** This does not apply to a Team A player who is blocked out of bounds and attempts to return inbounds immediately).

PENALTY – Live-ball foul. Five yards from the previous spot or if the scrimmage kick crosses the neutral zone, five yards from the spot where the subsequent dead ball belongs to Team B. [S19: OBK].

Approved Ruling 6-3-12

- I. A88 is running near the sideline to cover a punt when they step on the sideline and then return inbounds to continue down the field. They tackle the kick returner at the B-30. **RULING:** Foul by A88 for returning inbounds during the scrimmage kick down. Five-yard penalty. Team B may have the down repeated after the penalty or put the ball in play at the B-35.

Fouls By Kicking Team

ARTICLE 13. Penalties for all fouls by the kicking team other than kick-catch interference (Rule 6-4) during a scrimmage kick play (except field goal attempts) in which the ball crosses the neutral zone may be enforced by rule either at the previous spot as the basic spot with the down repeated (**Exception:** Penalty option is a safety for fouls in Team A's end zone) or at the spot where the subsequent dead ball belongs to Team B, at the option of Team B. (**A.R. 6-3-13:I-III**)

Approved Ruling 6-3-13

- I. Team A punts on fourth and seven at the A-35. At the snap Team A has five players in the backfield. The kick is partially blocked and goes out of bounds at the A-45. **RULING:** Foul for illegal formation. Team B may have the ball, first and 10 at the A-40 after the five-yard penalty is enforced at the A-45 (the dead-ball spot) or have the penalty enforced at the previous spot with fourth down repeated at the A-30. [Cited by 6-3-13]

- II. Team A punts on fourth and seven at the A-35. At the snap Team A has five players in the backfield. The kick is partially blocked, does not cross the neutral zone and is returned by B88 to the A-28 where they are tackled. **RULING:** Team B may decline the penalty and have the ball at the A-28 or have the penalty enforced at the previous spot with fourth down repeated at the A-30. [Cited by 6-3-13]
- III. Team A punts on fourth and seven at the A-35. At the snap Team A has five players in the backfield. The kick is partially blocked, crosses the neutral zone, goes back behind the neutral zone and rolls out of bounds at the A-32. **RULING:** Team B may have the ball, first and 10 at the A-27 after the five-yard penalty is enforced at the A-32 (the dead-ball spot) or have the penalty enforced at the previous spot with fourth down repeated at the A-30. [Cited by 6-3-13]
- IV. Fourth and 15 at the A-5. Punter A88, from Team A's end zone, kicks the ball. Tackle A77 is flagged for holding in the end zone. Team B returns the ball to the B-45. **RULING:** Team B has the option of having possession after the penalty is enforced from the B-45 to the A-45 or accepting the penalty for a safety. (Rule 10-2-4)

Defensive Linemen on Scrimmage Kick Plays

ARTICLE 14.

- a. If Team A is in a scrimmage kick formation at the snap **and the snapper is not on the end of the line of scrimmage**, any Team B player within one yard of the line of scrimmage must be aligned completely outside the frame of the body of the snapper at the snap (**A.R. 6-3-14:I-II**).
- b. If Team A is in a formation to attempt a place kick (field goal or try), it is illegal for three Team B players on their line of scrimmage inside the free-blocking zone to align shoulder-to-shoulder and move forward together after the snap with primary contact against a single Team A player (**A.R. 6-3-14:III-IV**).

PENALTY – Live-ball foul. Five yards from the previous spot [S19: IFD].

Approved Ruling 6-3-14

- I. 4/3 @ B-25. Team A is in a formation to attempt a field goal. B50 lines up within one yard of the line of scrimmage and in the gap between the snapper and the guard. B50's shoulder overlaps with the snapper's shoulder. The field goal attempt is good. **RULING:** Live-ball foul by B50. Team A may keep the 3 points and decline the penalty or accept the penalty, no score and have 1/10 @ B-20. [Cited by 6-3-14-a]
- II. 4/6 @ A-24. Team A is in scrimmage kick formation and punts. B50 is lined up inside the frame of the snapper and is within one yard of the line of scrimmage. The punt rolls out of bounds at the B-40. **RULING:** Live-ball foul by B50. Team A may accept the penalty and have 4/1 @ A-29 or decline the penalty and it will be Team B's ball, 1/10 @ B-40. [Cited by 6-3-14-a]
- III. Fourth and seven at the B-20. Team A is in a formation to attempt a field goal. Defensive linemen B55, B57, and B78 are shoulder to shoulder. B57 is head up on right guard A66 while B55 and B78 are in the gaps on A66's left and right shoulders, respectively. After the ball is snapped all three move forward together. (a) The three make their primary contact against A66; (b) B55 and B57 contact A66, and B78 drives at the right offensive tackle; (c) B57 and B78 make their blocks against A66 but B55 leaps to try to block the kick. **RULING:** (a) Foul. Five-yard penalty. If Team A accepts the penalty they will have fourth and two at the B-15. (b) and (c) No foul. The action by the Team B players does not involve primary contact against a single player, and hence the play is legal. [Cited by 6-3-14-b]
- IV. Fourth and four at the B-20. Team A is in a formation to attempt a field goal. Team A has five players in the backfield. Defensive linemen B55, B57, and B78 are shoulder to shoulder. B57 is head up on right guard A66 while B55 and B78 are in the gaps on A66's left and right shoulders, respectively. After the ball is snapped all three move forward together. The three make their primary contact against A66. The holder takes the snap, gets to their feet, and completes a pass to eligible A88 who is tackled at the B-10. **RULING:** Foul by Team A, illegal formation. Foul by Team B, triple team against an offensive lineman. The fouls offset and the down is repeated. [Cited by 6-3-14-b]

SECTION 4. Opportunity to Catch a Kick

Interference with Opportunity

- ARTICLE 1. a. If an inbounds player of the receiving team is located where they could catch a free kick or a scrimmage kick that is beyond the neutral zone, and if they are attempting to do so, they must be given an unimpeded opportunity to catch the kick (A.R. 6-3-1:III) (A.R. 6-4-1:V, VI and IX).
- b. It is an interference foul if, before the receiver touches the ball, a Team A player enters the area defined by the width of the receiver's shoulders and extending one yard in front of them. When in question it is a foul. (A.R. 6-4-1:X-XIII)
- c. This protection ends when the kick touches the ground (*Exception:* Free kick, Rule 6-4-1-f below), when any player of Team B muffs or touches a scrimmage kick beyond the neutral zone, or when any player of Team B muffs or touches a free kick in the field of play or in the end zone (*Exception:* Rule 6-5-1-b). (A.R. 6-4-1:IV)
- d. If interference with a potential receiver is the result of a player being blocked by an opponent, it is not a foul.
- e. It is an interference foul if the kicking team contacts the potential receiver before, or simultaneous to, their first touching the ball (A.R. 6-4-1:II, III and VIII). When in question, it is an interference foul.
- f. During a free kick, a player of the receiving team in position to receive the ball has the same kick-catch and fair-catch protection whether the ball is kicked directly off the tee or is immediately driven to the ground, strikes the ground once and goes into the air in the manner of the ball kicked directly off the tee.
- g. If contact by Team A is deemed to be a targeting foul (Rules 9-1-3 and 9-1-4) or any other personal foul that interferes with the receiver's opportunity to catch a kick, it may be ruled either as interference or as a targeting or personal foul. The 15-yard penalty is enforced at the spot where the dead ball belongs to Team B or at the spot of the foul, at the option of Team B.

PENALTY – For foul between the goal lines: Receiving team's ball, first down, 15 yards beyond the spot of the foul for an interference foul [S33: KCI]. For a foul on a free kick play behind the B-25-yard line against a player who has given a valid fair catch signal: Penalise from the B-25 [S33: KCI]. For foul behind the goal line: Award a touchback and penalise from the succeeding spot. Flagrant offenders shall be disqualified [S47: DSQ].

Approved Ruling 6-4-1

- I. A Team A player catches a free kick very near receiver B25, thus preventing them from making the catch. **RULING:** Kick-catch interference. Penalty — 15 yards from the spot of the foul.
- II. A Team B player, about to catch a scrimmage kick, is tackled before the ball arrives, but catches the kick while they are falling. **RULING:** Kick-catch interference. Penalty — 15 yards from the spot of the foul. Disqualification of the Team A player if the contact is flagrant. If the foul is between the goal lines, enforcement is from the spot of the foul and Team B puts the ball in play by a snap; if behind Team B's goal line, award a touchback and penalise from the succeeding spot. The ruling would be the same had the kick been muffed or fumbled. The ruling also applies on an unsuccessful field goal attempt since Team B touched the ball beyond the neutral zone. [Cited by 6-4-1-e]
- III. While a kick is in flight beyond the neutral zone, A1 is standing or running between the ball and B1. (a) The ball strikes A1 while B1 is in a position to catch the ball. (b) B1, in attempting to catch the ball, bumps into A1. **RULING:** (a) and (b) Kick-catch interference. Penalty — 15 yards at the spot of the foul. [Cited by 6-4-1-e]
- IV. A player of Team B, attempting to catch a kick (no fair catch signal), muffs the ball that is then touched by an opponent who was not interfering with the opportunity of the receiver when they were in position to make the catch. **RULING:** Not interference. In the absence of a fair catch signal, protection against interference with the opportunity to catch a kick ends when any player of Team B muffs the ball. [Cited by 6-4-1-c]

- V. A Team A player beyond the neutral zone first touches or catches a scrimmage kick that no receiver could have caught while it was in flight. **RULING:** Illegal touching but not interference. [Cited by 6-4-1-a]
- VI. B25 is standing at the B-35 in position to catch a punt. As the ball is on its downward flight, A88 runs by B25 very close to their side, causing B25 to adjust their position before catching the ball. A88 does not make contact and does not penetrate the one-yard area directly in front of B25. **RULING:** Foul by A88, interference with the opportunity to catch the kick. 15 yards, spot of the foul. Even though B25 catches the ball, A88's action causes them to move away from their original location and thus interferes with their opportunity to make the catch. [Cited by 6-4-1-a]
- VII. B10 signals for a fair catch, muffs the ball and then catches it. **RULING:** If B10 has an opportunity to catch the kick after the muff, they must be given an unimpeded opportunity to complete the catch. If B10 catches the muffed kick, the ball is dead where they first touched it. [Cited by 6-5-1-b]
- VIII. Fourth and 10 at the 50-yard line. B17 is at Team B's 20-yard line and in position to catch Team A's high scrimmage kick. During the downward flight of the ball, A37 contacts B17 viciously and flagrantly before they touch the ball. A37 did not alter their speed or make any attempt to elude B17. **RULING:** Team A flagrant personal foul, interference with the opportunity to catch a kick. Penalty — 15 yards from the spot of the foul. A37 is disqualified. [Cited by 6-4-1-e]
- IX. Team A's ball, fourth and 10 at the 50-yard line. Team A's windblown scrimmage kick is on its downward flight at Team B's 30-yard line. B18, starting at the 20-yard line, must detour around A92 at the 25-yard line to make the catch at the 30-yard line. **RULING:** Foul by A92 for interference with the opportunity to catch a kick. Penalty — 15 yards from the spot of the foul, which is the 25-yard line. [Cited by 6-4-1-a]
- X. Punt receiver B44 is standing at their 30-yard line in position to catch the kick. Defender A11 races down the field to cover the punt and reaches a point about a foot directly in front of B44 as the ball descends. B44 makes the catch without having to adjust their position or manner of catching the ball because of the presence of A11, who does not pull back to give B44 more room. **RULING:** Foul for kick-catch interference. A11 entered the one-yard area directly in front of receiver B44. 15-yard penalty. [Cited by 6-4-1-b]
- XI. Punt receiver B22 is at the B-30 awaiting the punt as it makes its downward flight and their teammate B88 is three yards in front of them at the B-33. Down field to cover the kick, A44 legally blocks B88 into B22 just as the ball reaches them. The ball hits B22 in the shoulder and bounces away. Team A recovers at the B-25. **RULING:** Team A's ball, first and 10 at the B-25. This is not kick-catch interference. The action by A44 is against B88 who is not in position to catch the kick, and not against B22. Thus A44 is not deemed to have interfered with B22's opportunity to catch the ball. B22's touching of the ball allows Team A to recover legally. [Cited by 6-4-1-b]
- XII. Fourth and five at the A-30. Punt receiver B22 is in position to catch the kick at the B-30. They do not signal. A88 is within a yard of B22, at their side, but does not make contact with B22 when they catch the kick at the B-30. B22 is tackled at the B-32. A88's presence does not cause B22 to make any adjustment to their position or their manner of catching the ball. **RULING:** Legal play; no kick-catch interference. A88 is closer than one yard to B22 but is not directly in front of them. They do not affect B22's opportunity to catch the ball. First and 10 for Team B at the B-32. [Cited by 6-4-1-b]
- XIII. B44 is in position to catch a punt at the B-25. While the ball is still very high in the air and well before it comes close to B44, A88 runs directly in front of B44 within a yard but is not near them when the ball arrives. B44 catches the punt and is tackled. **RULING:** No foul. Although A88 penetrates the one-yard region directly in front of the receiver, this is so early in the action that there is no interference with B44's opportunity to catch the kick. [Cited by 6-4-1-b]

SECTION 5. Fair Catch

Dead Where Caught

ARTICLE 1. a. If a Team B player makes a fair catch, the ball becomes dead where caught and belongs to Team B at that spot. [**Exception:** If a Team B player makes a fair catch of a free kick behind Team B's 25-yard line, the ball belongs to Team B at its own 25-yard line. The next snap shall be from midway between the hashmarks, unless a different position on or between the hashmarks is selected by the team designated to put the ball in play before the play clock is at 25 seconds or before any subsequent ready-for-play signal. After the play clock is at 25 seconds or any subsequent ready-for-play signal, the ball may be relocated only after a charged team timeout unless preceded by a Team A foul or offsetting fouls.]

- b. If a Team B player makes a valid fair catch signal, the unimpeded opportunity to catch a free or scrimmage kick continues if this player muffs the kick and still has an opportunity to complete the catch. If they (or another Team B player) subsequently catch the kick, the ball belongs to Team B where the player making the signal first touched it. This protection terminates when the kick touches the ground. **(A.R. 6-5-1:I-III) (A.R. 6-4-1:VII)**
- c. Rules pertaining to a fair catch apply only when a scrimmage kick crosses the neutral zone or during free kicks.
- d. The purpose of the fair catch provision is to protect the receiver who, by using the fair catch signal, agrees they or a teammate will not advance after the catch. **(A.R. 6-5-5:III)**
- e. The ball shall be put in play by a snap by the receiving team at the spot of the catch if the ball is caught (*Exception:* Rules 6-5-1-a, 6-5-1-b, 7-1-1-c and 8-6-1-b).

Approved Ruling 6-5-1

- I. After a valid or invalid signal, B1 muffs the punt and B2, who did not signal, catches the kick. **RULING:** The ball is dead when B2 catches it and the ball is placed where B1 first touched it. [Cited by 6-5-1-b, 6-5-3-b]
- II. B1 has a foot out of bounds when they give a valid or invalid signal. They then catch the kick inbounds. **RULING:** There is no rule against a receiver going out of bounds during a kick. The inbounds catch is legal, and the ball is dead. [Cited by 6-5-1-b]
- III. During a free kick, B21 signals for a fair catch at the B-5. B21 muffs the kick but immediately recovers the ball at the B-5. **RULING:** Not a completed Fair Catch. Team B ball, first and 10 at the B-5. [Cited by 6-5-1-b]

No Advance

ARTICLE 2. No Team B player shall carry a caught or recovered ball more than two steps in any direction after any Team B player gives a valid or invalid fair catch signal. **(A.R. 6-5-2:I-III)**

PENALTY – Dead-ball foul, delay of game. Five yards from the succeeding spot [S7 and S21: DOG].

Approved Ruling 6-5-2

- I. B1 gives a fair catch signal before a muff by B2, and then B1 catches or recovers the kick and advances. **RULING:** Because of B1's signal, the ball is dead where caught or recovered. Two steps are permitted to enable B1 to come to a stop or to regain balance. A third or subsequent step inbounds is subject to penalty from where the ball is caught or recovered. If B1 is tackled, the tackle is disregarded unless deemed unnecessarily rough or is so late that the tackler should know that there was no intention to advance. If the kick is caught or recovered by Team B in the end zone, it is a touchback. If B1 is tackled before completion of a third step, only the tackler has fouled. [Cited by 6-5-2]
- II. Team A punts. After signalling for a fair catch on their 20-yard line, B1 deliberately lets the ball strike the ground where B2 recovers the bouncing ball and advances to Team B's 35-yard line. **RULING:** The ball is dead at the spot of recovery. Advance is illegal. Penalty — Five yards from the succeeding spot, the spot of recovery. Team B's ball, first and 10 (Rule 5-2-7). [Cited by 6-5-2]
- III. Punt receiver B22 gives an invalid fair catch signal by a brief flick of their upraised hand. They catch the ball at the B-35 and sprint to the B-40 where they are tackled. **RULING:** The ball is dead where caught. Foul for delay of game by B22; five-yard penalty from the dead-ball spot. No foul by the tackler, as clearly B22 gave the appearance of being a ball carrier. First and 10 for Team B at the B-30. [Cited by 6-5-2]

Invalid Signals: Catch or Recovery

- ARTICLE 3. a. A catch after an invalid signal is not a fair catch, and the ball is dead where caught or recovered. (*Exception:* During a free kick, if a Team B receiver gives any waving signal that does not meet all of the requirements of a valid fair catch signal, and subsequently catches the ball behind the B-25 yard line, the ball belongs to Team B at its own 25-yard line) **(A.R. 6-5-3:VI)**
- b. If the signal follows a catch or recovery, the ball is dead when the signal is first given. **(A.R. 6-5-1:I)**
- c. Invalid signals beyond the neutral zone apply only to Team B.
- d. An invalid signal beyond the neutral zone is possible only when the ball has crossed the neutral zone (Rule 2-16-7). **(A.R. 6-5-3:I)**

Approved Ruling 6-5-3

- I. A1 or B1 signals for a fair catch beyond the neutral zone during a kick that does not cross the neutral zone. **RULING:** Any signal by Team A is ignored. Team B may not make a fair catch signal because the ball did not cross the neutral zone. However, the ball is dead when caught or recovered (Rules 2-8-1-a and 4-1-3-g). [Cited by 6-5-3-d]
- II. On a free kick, B17 makes an invalid signal for a fair catch near the sideline, muffs the ball, and it goes out of bounds. **RULING:** Team B's ball, first and 10 at the hash mark. [Cited by 6-2-2]
- III. A scrimmage kick strikes the ground beyond the neutral zone and bounces high into the air and B1 signals for a fair catch. **RULING:** Invalid signal. The ball is dead when recovered. [Cited by 2-8-3-c]
- IV. B1 catches a scrimmage kick beyond the neutral zone and then signals for a fair catch. **RULING:** Invalid signal. The ball is dead where the signal first was given. [Cited by 2-8-3-c]
- V. Team A's scrimmage kick is rolling beyond the neutral zone when B17 alerts their teammates to stay away from the ball by a "get away" signal. **RULING:** Invalid signal. The ball is dead by rule when either team recovers. [Cited by 2-8-3-c]
- VI. While a free kick is in the air, B21 gives a waving signal that does not meet all the requirements of a valid fair catch signal. The ball is caught by: (a) B21 at the B-5; or (b) B44 at the B-5. **RULING:** The ball is dead when caught. (a) Team B ball, first and 10 at the 25-yard line; (b) Team B ball, first and 10 at the 5-yard line. [Cited by 6-5-3-a]

VII. While a free kick is in the air, B21 gives a "T signal" thinking he will not return the kick. The ball is caught by: (a) B21 at the B-5; or (b) B44 at the B-5. **RULING:** The ball is dead when caught. (a) Team B ball, first and 10 at the 25-yard line; (b) Team B ball, first and 10 at the 5-yard line. [Cited by 2-8-3-b]

Illegal Block or Contact

ARTICLE 4. A player of Team B who has made a valid or invalid signal for a fair catch and does not touch the ball shall not block or foul an opponent during that down. (**A.R. 6-5-4:I and II**)

PENALTY – Free kick: Receiving team's ball 10 yards from the spot of the foul [S40: IBK].

Scrimmage kick: 10 yards, postscrimmage kick enforcement [S40: IBK]. If a personal foul is committed in conjunction with this action, the penalty is 15 yards and flagrant offenders shall be disqualified [S47: DSQ].

Approved Ruling 6-5-4

- I. B1 gives either a valid or invalid fair catch signal and does not touch a punt. While the untouched ball is loose in the field of play, they block an opponent (a) in the field of play beyond the neutral zone or (b) in Team B's end zone. **RULING:** (a) If the ball crosses the neutral zone and Team B has possession when the down ends, Team B is penalised 10 yards from the postscrimmage kick enforcement spot. (b) Safety. The ruling is the same on an unsuccessful field goal attempt. [Cited by 6-5-4]
- II. B1 signals at the 50-yard line and does not touch a punt. While the ball is rolling on the ground at Team B's 45-yard line, B1 uses their hands to shove an opponent to get to the ball and the ball is declared dead in Team B's possession. **RULING:** Penalty — 10 yards, postscrimmage kick enforcement. The ball belongs to Team B (Rule 10-2-3). [Cited by 6-5-4]

No Tackling

ARTICLE 5. No player of the kicking team shall tackle or block an opponent who has completed a fair catch. Only the player making a fair catch signal has this protection (**A.R. 6-5-5:I-III**).

PENALTY – Dead-ball foul. Receiving team's ball 15 yards from the succeeding spot [S7 and S38: PF-UNR].

Approved Ruling 6-5-5

- I. B1 and B2 each signal. B1 muffs, and B2 is about to catch the muffed ball when A1 grabs and pulls them to the ground. **RULING:** Not interference, but holding. Penalty — 10 yards from the previous spot or from the spot where the subsequent dead ball belongs to Team B. [Cited by 6-5-5]
- II. B22 makes a fair catch and is tackled before they have carried the ball more than two steps. **RULING:** Foul by the tackler. Penalty — 15 yards from the succeeding spot. [Cited by 6-5-5]
- III. B1 catches the punt after B3 signals for a fair catch. **RULING:** The ball is dead when and where caught. B1 is not entitled to catch protection but is entitled to the same protection they have after any other dead ball (Rule 6-5-1-d). [Cited by 6-5-1-d, 6-5-5]

RULE 7

Snapping and Passing the Ball

SECTION 1. The Scrimmage

Starting with a Snap

- ARTICLE 1. a. The ball shall be put in play by a legal snap unless the rules provide for a legal free kick.
- b. No player shall put the ball in play before it is ready for play (Rule 4-1-4). **(A.R. 4-1-4:I and II)**
- PENALTY – [a-b] Dead-ball foul. Five yards from the succeeding spot [S7 and S19: ISP/IPR].**
- c. The ball may not be snapped in a side zone (Rule 2-31-6). If the starting point for any scrimmage down is in a side zone, the ball shall be transferred to the nearest hash mark.

Shift and False Start

- ARTICLE 2. a. *Shift*. After a huddle (Rule 2-14) or shift (Rule 2-22-1) and before the snap, all Team A players must come to an absolute stop and remain stationary in their positions without movement of the feet, body, head or arms for at least one full second before the ball is snapped. **(A.R. 7-1-2:I)**
- b. *False Start*. Each of the following is a false start by Team A if it occurs prior to the snap after the ball is ready for play and all players are in scrimmage formation:
1. Any movement by one or more players that simulates action at the snap. This includes abruptly shifting a player or players that simulates the start of a play.
 2. The snapper moving to another position.
 3. A restricted lineman (Rule 2-27-4) moving their hand(s) or making any quick movement.
- Exceptions:**
- (a) It is not a false start if a Team A lineman immediately reacts when threatened by a Team B player in the neutral zone (Rule 7-1-5-a-2) **(A.R. 7-1-3:V)**.
 - (b) It is not a false start if the snapper takes their hand(s) off the ball, provided this does not simulate the start of a play (Rule 7-1-3-a-3).
4. An offensive player making any quick, jerky movement before the snap, including but not limited to:
 - (a) A lineman moving their foot, shoulder, arm, body or head in a quick, jerky motion in any direction.
 - (b) The snapper shifting or moving the ball, moving their thumb or fingers, flexing their elbows, jerking their head, or dipping their shoulders or buttocks.
 - (c) The quarterback making any quick, jerky movement that simulates the beginning of a play.
 - (d) A back simulating receiving the ball by making any quick, jerky movement that simulates the beginning of a play **(A.R. 7-1-3:VI)**.
 5. The offensive team never coming to a one-second stop prior to the snap after the ball is ready for play. **(A.R. 7-1-2:IV)** This is an illegal shift that converts to a false start.

Approved Ruling 7-1-2

- I. After a huddle or shift, all Team A players come to a stop and remain stationary for one second. Then, before the snap, two or more simultaneously change their positions. **RULING:** All 11 Team A players must again stop for one second before the snap, otherwise it is a live-ball foul at the snap for an illegal shift. Penalty — Five yards from previous spot (Rule 2-22-1). [Cited by 2-22-1-a, 7-1-2-a]
- II. Ten Team A players shift while A1 remains stationary. A1 then starts moving backward before one second elapses and the ball is snapped. **RULING:** If A1, who moved, did not halt with the other Team A players for one second before the snap, it is a dead-ball foul at the snap for a false start. Penalty — Five yards from the succeeding spot. [Cited by 2-22-1-a]
- III. After the Team A players have stopped for one second, end A88 runs wide and stops, and before one second elapses, back A36 starts moving backward. **RULING:** Legal. But if back A36 starts before end A88 stops, the simultaneous movement of two players constitutes a shift, and all Team A players must be stationary for one second before the snap (Rule 2-22-1). [Cited by 2-22-1-a]
- IV. Team A is in a no-huddle offense and is moving to the line when the ball is made ready for play. Although some players settle into their positions and stop, at least one player never stops and is still moving when the ball is snapped. **RULING:** Dead-ball foul — Illegal shift that converts to a false start. Team A never satisfied the one-second rule before the snap. Officials should shut the play down and penalise Team A five yards. [Cited by 2-22-1-a, 7-1-2-b-5]
- V. Team A has 3rd and 3 at the B-40. QB A12 is in shotgun formation, (a) makes a fake clap standing in position; (b) makes a fake clap while chucking their shoulders and hands forward in an exaggerated motion simulating the start of the play. **RULING:** Rule 7-1-2-b-4-c states that it is a false start if the quarterback makes any quick, jerky movement that simulates the start of the play. In (a) no foul; (b) false start on A12.

Offensive Team Requirements — Prior to the Snap

ARTICLE 3. Each of the following (a-d) is a dead-ball foul. Officials should blow the whistle and not allow the play to continue. After the ball is ready for play and before it is snapped:

- a. *Snapper.* The snapper (Rule 2-27-8):
 1. May not move to a different position nor have any part of their body beyond the neutral zone.
 2. May not lift the ball, move it beyond the neutral zone or simulate the start of a play.
 3. May take their hand(s) off the ball, but only if this does not simulate the start of a play.
- b. *Nine-Yard Marks.*
 1. Each Team A substitute must have been between the nine-yard marks. Team A players who participated in the previous down must have been between the nine-yard marks after the previous down and before the next snap. **(A.R. 3-3-4:I)**
 2. All Team A players must have been between the nine-yard marks after a charged team timeout, an injury timeout, a media timeout or the end of a period.
- c. *Encroachment.* Once the snapper is established, no other Team A player may be in or beyond the neutral zone [**Exceptions:** (1) Substitutes and departing players; and (2) offensive players in a scrimmage kick formation who break the neutral zone with their hand(s) to point at opponents].
- d. *False Start.* No Team A player may commit a false start (Rule 7-1-2-b) or contact an opponent. **(A.R. 7-1-3:III)**

PENALTY – [a-d] Dead-ball foul: Five yards from the succeeding spot. [S7 and S19: FST/ENC].

Approved Ruling 7-1-3

- I. A21 is legally on the end of the line of scrimmage next to A88, who is in a three-point stance. Team A stops for one second while A21 and A88 are in the above positions, and then A21 moves to a legal backfield position and stops. Then A88 shifts to a wider position on the line. **RULING:** Legal if both A21 and A88 are stationary at the snap (Rules 2-22-1 and 7-1-4). [Cited by 2-22-1-a, 7-1-4-c]
- II. A21 is legally on the end of the line of scrimmage next to A88, who is in the stance of a restricted lineman. Team A has stopped for one second when A21 leaves the line of scrimmage and goes in motion into the backfield. A88 shifts to a wider position on the line. **RULING:** A88 may break their three-point stance

since they are now on the end of the line of scrimmage, but Team A must stop again for one second before the snap to make the play legal (Rule 7-1-4). [Cited by 2-22-1-a, 7-1-4-c]

- III. B71 crosses the neutral zone into the Team A backfield and does not threaten any Team A player. A23, legally in the backfield, intentionally reaches to contact B71. **RULING:** Team A foul, false start. Penalty — Five yards from the succeeding spot. [Cited by 7-1-3-d]
- IV. Snapper A1 lifts or moves the ball forward before moving it backward to start the snap. B2 bats the ball, causing it to roll loose with B3 recovering. **RULING:** Team A foul, illegal snap, ball remains dead. Penalty — five yards from succeeding spot (Rule 4-1-1). [Cited by 4-1-1]
- V. A66, a restricted lineman between the snapper and the player on the end of the line, or A72, a restricted player on the end of the line of scrimmage:
 1. Lifts a hand or hands from the ground immediately when threatened by B1, who is in the neutral zone. **RULING:** Blow the whistle immediately. Team B dead-ball foul, offside. Penalty — Five yards from the succeeding spot.
 2. Lifts a hand or hands from the ground upon initial charge by B1, who (a) does not enter the neutral zone or (b) enters the neutral zone but does not threaten the position of A66 or A72. **RULING:** In both (a) and (b), blow the whistle immediately. Team A dead-ball foul, false start. Penalty — Five yards from the succeeding spot. [Cited by 2-18-2-d, 7-1-2-b-3-a, 7-1-5-a-2]

NOTE: Before the snap, a Team B player who enters the neutral zone may threaten a maximum of three Team A linemen. If the Team B player enters the neutral zone directly toward a Team A lineman, then that Team A player and the two adjacent linemen are considered to be threatened. If the Team B player enters the neutral zone directly toward a gap between two Team A linemen, then only those two Team A players are considered to be threatened. Adjacent linemen are those who are within 2 yards of each other.
- VI. A80 on the end of the line, a non-restricted interior lineman or a back, misses the snap count and makes a casual movement that is not abrupt, quick or jerky and does not simulate the start of a play. **RULING:** No foul by Team A. [Cited by 7-1-2-b-4-d]

Offensive Team Requirements — At the Snap

ARTICLE 4. Violation of each of the following (a-c) is a live-ball foul; the play is allowed to continue.

- a. *Formation.* At the snap, Team A must be in a formation that meets these requirements:
 1. All players must be inbounds.
 2. All players must be either linemen or backs (Rule 2-27-4). (**A.R. 7-1-4:IX**)
 3. At least five linemen must wear jerseys numbered 50 through 79 (**Exception:** When the snap is from a scrimmage kick formation, paragraph 5 below.)
 4. No more than four players may be backs (**A.R. 7-1-4:III**).
 5. In a scrimmage kick formation at the snap (Rule 2-16-10) Team A may have fewer than five linemen numbered 50-79, subject to the following conditions: (**A.R. 7-1-4:VII**).
 - (a) Any and all linemen not numbered 50-79 who are ineligible receiver(s) by position become exceptions to the numbering rule when the snapper is established.
 - (b) Any and all such numbering-exception players must be on the line and may not be on the end of the line. Otherwise, Team A commits a foul for an illegal formation.
 - (c) Any and all such players are exceptions to the numbering rule throughout the down and remain ineligible receivers unless they become eligible under Rule 7-3-5 (forward pass touched by an official or a Team B player).

The conditions in 5(a)-5(c) are no longer in effect if prior to the snap a period ends or there is a timeout charged to the referee or one of the teams.
- b. *Player in motion.*
 1. One back may be in motion, but they may not be moving toward their opponent's goal line (**A.R. 7-1-4:I-II, X**).
 2. The player who goes in motion may not start from the line of scrimmage unless they first become a back and come to a complete stop.

3. A player in motion at the snap must have satisfied the one-second rule — i.e., they may not start their motion before any shift has ended (Rule 2-22-1-c).

c. *Illegal shift.* At the snap, Team A may not execute an illegal shift (Rule 7-1-2-a). (**A.R. 7-1-3:I-II**)

PENALTY – [a-c] Live-ball foul: Five yards from the previous spot [S19 or S20: ILF/ILM/ISH]. For live-ball fouls occurring when or after the snap starts during scrimmage kick plays other than field goal plays: Five yards from the previous spot or if the kick crosses the neutral zone, five yards from the spot where the subsequent dead ball belongs to Team B.

Approved Ruling 7-1-4

- I. A30, lined up legally as a back, starts in motion legally. They then turn so that they still are legally in motion but are facing their line of scrimmage using a "side-step" motion. At the snap, A30 is bent slightly forward at the waist and is either continuing their "side-step" motion or is "marking time" in place. **RULING:** Legal. [Cited by 7-1-4-b-1]
- II. A30, lined up legally as a back, starts in motion legally. They then turn so that they still are legally in motion but are facing their line of scrimmage using a "side-step" motion. At the snap, A30, still behind the neutral zone, is moving slightly forward from the waist up or their "side-step" motion has veered slightly toward the line of scrimmage. **RULING:** Live-ball foul at the snap for illegal motion. Penalty — Five yards from the previous spot. [Cited by 7-1-4-b-1]
- III. Team A's formation at the snap includes only 10 players: five players on the line of scrimmage numbered 50-79, one player on the line wearing number 82, and four players in the backfield. **RULING:** The formation is legal because Team A has no more than four players in the backfield and the required number of players (five) on the line wearing 50-79. [Cited by 7-1-4-a-4]
- IV. Team A, with fourth and eight, sends two substitutes numbered 21 and 33 into the game as exceptions to the mandatory numbering, and they are positioned legally on their line of scrimmage between the end players on the line of scrimmage. After the ball is snapped, a Team A player, 15 yards deep in a scrimmage kick formation, throws a legal forward pass to an eligible receiver for a 10-yard gain. **RULING:** Legal play (Note: The same play from a field goal formation is legal). [Cited by 1-1-1-b-2]
- V. A33, an exception to the mandatory numbering rule, assumes a position on the line of scrimmage next to end A88. Before the snap, A88 moves to a backfield position and the flanker on the opposite side of the line moves to an end position on the line. **RULING:** Illegal formation. Since A33 is now an end, they are thus in an illegal position at the snap (live-ball foul). Penalty — five yards from the previous spot. [Cited by 1-1-1-b-2]
- VI. A33, an exception to the mandatory numbering rule, assumes a position on the line of scrimmage to the left of snapper A85, who is on the end of the line. All other Team A players on the line are to A33's left. After a one-second stop, all players on the line except A85 legally shift to the other side of the ball, with A33 now positioned as an end. **RULING:** If the ball is snapped with A33 in this position, it is a foul for an illegal formation. A33 may not legally be on the end of the line at the snap. Penalty — five yards from the previous spot. [Cited by 1-1-1-b-2]
- VII. At the B-45, Team A is in a formation in which the snapper A88 is on the right end of the line. The linemen on their left are numbered 56, 63, 72, 22, 79, and 25. There are four players in the backfield. A44 is ten yards directly behind the snapper, and the other backs are to their left a few yards behind the line of scrimmage. No player is in position to hold for a place kick. After the snap, A44 completes a pass to snapper A88 for a touchdown. This happens on (a) first or second down; (b) third or fourth down. **RULING:** Because there are only four offensive linemen numbered in the 50-79 range, the legality of the play depends on whether Team A is in a scrimmage kick formation. One of the requirements for such a formation is that "it is obvious that a kick will be attempted." (a) Illegal formation: on first or second down, a team is very unlikely to punt, so it is not obvious that a kick will be attempted. (b) Legal play: touchdown. On third or fourth down a team may be likely to kick (Rule 2-16-10). [Cited by 7-1-4-a-5]
- VIII. On fourth down, Team A lines up with A11 ten yards directly behind the snapper. The other three backs are split wide, all outside the tackle box. Only four Team A linemen have uniform numbers between 50 and 79. A11 receives the backward pass from the snapper with Team A in this formation. **RULING:** Legal formation and a scrimmage kick formation. Team A can put all its backs to the side of the field where the kicker intends to kick the ball, if it wishes (Rule 2-16-10). [Cited by 2-16-10-a]
- IX. Team A lines up with six players on the line of scrimmage, five of whom are numbered in the range 50-79. A seventh player, A88, is in the normal location of an end, but they are positioned so that their feet and shoulders are clearly at a 45-degree angle with the line of scrimmage. The other four players are clearly

- in the backfield. The ball is snapped with Team A in this alignment. **RULING:** Live-ball foul, illegal formation. Every Team A player must be either a lineman or a back; A88 is neither. [Cited by 7-1-4-a-2]
- X. A30, lined up legally as a back, starts in motion toward their opponent's goal line. One yard behind the line of scrimmage, they turn so that they are still in motion but facing the sideline and moving parallel to the line of scrimmage. At the snap, A30 is in motion one yard behind the line of scrimmage. **RULING:** Legal play. [Cited by 7-1-4-b-1]

Defensive Team Requirements

ARTICLE 5. The defensive team requirements are as follows:

- a. Each of the following (1-5) is a dead-ball foul. Officials should blow the whistle and not allow the play to continue. After the ball is ready for play and before the ball is snapped:
1. No player may touch the ball except when moved illegally as in Rule 7-1-3-a-1, nor may any player contact an opponent or in any other way interfere with them. (A.R. 7-1-5:I-II)
 2. No player may enter the neutral zone threatening an offensive lineman and causing them to react immediately, or commit any other dead-ball offside foul (Rules 2-18-2 and 7-1-2-b-3 Exceptions). (A.R. 7-1-3:V) (A.R. 7-1-5:III)
 3. No player may cross the neutral zone and without making contact continue their charge toward any back.

PENALTY – [1-3] Dead-ball foul, offside. Five yards from the succeeding spot [S18: DOF].

4. No player within one yard of the line of scrimmage (stationary or not) may make **quick and abrupt or exaggerated actions that simulate action at the snap, and** are not part of normal defensive player movement **in an obvious attempt to make the offense foul (false start).** (A.R. 7-1-5:IV)
5. No person subject to the rules shall use words or signals that disconcert opponents when they are preparing to put the ball in play. No person subject to the rules may call defensive signals that simulate the sound or cadence of, or otherwise interfere with, offensive starting signals. **The terms "move" and "stem" are reserved for defensive cadence and may not be used by the offense. The offense may use a "clap" as a starting signal and this signal may not be used by the defense** (A.R. 7-1-5:V).

PENALTY – [4-5] Dead-ball foul, delay of game. Five yards from the succeeding spot [S21: DOD].

- b. When the snap starts:
1. No player may be in or beyond the neutral zone at the snap.
 2. All players must be inbounds.

PENALTY – Live-ball foul. Five yards from the previous spot [S18: DOF].

Approved Ruling 7-1-5

- I. Snapper A1 lifts the ball before passing it backward, B2 bats the ball away and B3 recovers the ball. **RULING:** Team A dead-ball foul, illegal snap. The ball remains dead because it was not put in play by a legal snap. Penalty — Five yards from the succeeding spot. Team A retains possession. [Cited by 2-23-1-b, 2-23-1-f, 4-1-1, 7-1-5-a-1]
- II. Snapper A1 legally begins the snap, but B2 bats the ball before A1 completes the snap, and B3 recovers the ball. **RULING:** Team B foul and the ball remains dead. Penalty — Five yards from the succeeding spot. Team B may not touch the ball until it has been snapped. Team A retains possession. [Cited by 2-23-1-b, 2-23-1-f, 4-1-1, 7-1-5-a-1]
- III. Before the snap, a Team B player crosses the neutral zone and, without making contact, continues their charge behind a Team A lineman and directly toward the quarterback or kicker. **RULING:** A Team B player who is on Team A's side of the neutral zone and is moving in a direct path toward the quarterback or kicker while they are behind an offensive lineman is considered to be interfering with Team A's formation. Penalty — Team B dead-ball foul, offside. Five yards from the succeeding spot. [Cited by 2-18-2-e, 7-1-5-a-2]

- IV. Linebacker B56 is stationary within one yard beyond the neutral zone. As the offense is calling its snap signals, B56 feints toward the line in an obvious attempt to induce a false start by the offense. **RULING:** Dead-ball foul, delay of game. Five-yard penalty at the succeeding spot. [Cited by 7-1-5-a-4]
- V. 3/2 @ B-45. Team A is in formation and the snap is imminent. The QB is in shotgun formation and is using a clap as a starting signal. A Team B (a) squad member; (b) assistant coach claps causing the Team A wideout to false start or the snapper to snap the ball. **RULING:** Dead-ball foul, delay of game for disconcerting signals [S21] for both (a) and (b). Team A will have 1/10 @ B-40. The rule states that no person subject to the rules may call defensive signals that simulate the sound or cadence of, or otherwise interfere with, offensive starting signals. The rule covers squad members or coaches that clap when the snap is imminent and could cause the offense to false start. [Cited by 7-1-5-a-5]

Handing the Ball Forward

ARTICLE 6. No player may hand the ball forward except during a scrimmage down [prior to a change in team possession](#) as follows:

- a. A Team A back may hand the ball forward to another back only if both are behind their scrimmage line and the player handing the ball forward has not had their entire body beyond the neutral zone while in possession of the ball.
- b. A Team A back behind their scrimmage line may hand the ball forward to a teammate who is on their scrimmage line at the snap, provided that teammate leaves their line position by a movement of both feet that faces them toward their own end line and is at least two yards behind their scrimmage line when they receive the ball. (A.R. 7-1-6:I)

PENALTY – Five yards from the spot of the foul; also loss of a down if by Team A before team possession changes during a scrimmage down [S35 and S9: IFH].

Approved Ruling 7-1-6

- i. Eligible receiver A83 is on the end of their scrimmage line and adjacent to the snapper in an unbalanced "T" formation. Quarterback A10 receives a handed snap and immediately conveys the ball to A83. **RULING:** If the movement of the ball is forward and it left A10's hand before having been touched by A83, it is a legal forward pass. A83 may have turned sufficiently to receive a backward pass or handoff (legal); but if the action immediately followed the snap, it is not likely that a handoff would have had time to comply with the "turn" and "two yards behind the line" requirement. [Cited by 7-1-6-b]

Planned Loose Ball

ARTICLE 7. A Team A player may not advance a planned loose ball in the vicinity of the snapper.

PENALTY – Five yards from the previous spot and loss of down [S19 and S9: IPR].

SECTION 2. Backward Pass and Fumble

During Live Ball

ARTICLE 1. A ball carrier may hand or pass the ball backward at any time, except to throw the ball intentionally out of bounds to conserve time.

PENALTY – Five yards from the spot of the foul; also loss of down if by Team A before team possession changes during a scrimmage down (A.R. 3-4-3:III) [S35 and S9: IBP].

Caught or Recovered

ARTICLE 2. a. When a backward pass or fumble is caught or recovered by any inbounds player, the ball continues in play. (A.R. 2-23-1:I)

Exceptions:

1. Rule 8-3-2-d-5 (Team A fumble on the try).
2. On fourth down, before a change of team possession, when a Team A fumble is caught or recovered by a Team A player other than the fumbler, the ball is dead. If the catch or recovery is beyond the spot of the fumble, the ball is returned to the spot of the fumble. If the catch or recovery is behind the spot of the fumble, the ball remains at the spot of the catch or recovery.

- b. When a backward pass or fumble is caught or recovered simultaneously by opposing players, the ball becomes dead and belongs to the team last in possession (**Exception:** Rule 7-2-2-a Exceptions).

After the Ball is Snapped

ARTICLE 3. No offensive lineman may receive a hand-to-hand snap.

PENALTY – Live-ball foul. Five yards from the previous spot [S19: IPR].

Out of Bounds

ARTICLE 4. a. When a backward pass or fumble goes out of bounds between the goal lines: (**A.R. 7-2-4:II**)

1. In advance of the spot of the backward pass or fumble, the ball belongs to the passing or fumbling team at the spot of the backward pass or fumble.
 2. Behind the spot of the backward pass or fumble, the ball belongs to the passing or fumbling team at the out-of-bounds spot.
- b. *Behind or Beyond Goal Line.* When a fumble or backward pass goes out of bounds behind or beyond a goal line, it is a safety or touchback depending on impetus and responsibility (Rules 8-5-1, 8-6-1 and 8-7). (**A.R. 7-2-4:I**) (**A.R. 8-6-1:I**) (**A.R. 8-7-2:I**)

Approved Ruling 7-2-4

- I. B20 intercepts a legal forward pass (a) in their end zone, (b) on their three-yard line, and their momentum carries them into their end zone, or (c) in the field of play and retreats into their end zone (no momentum). In each instance, B20 fumbles in the end zone and the ball rolls forward and out of bounds on Team B's two-yard line. **RULING:** The ball belongs to Team B at the spot of the fumble (Team B's end zone); (a) touchback, (b) Team B's ball at the three-yard line, and (c) safety (Rules 8-5-1 and 8-6-1). [Cited by 7-2-4-b, 8-5-1-a, 8-6-1-a]
- II. On second down, A1 fumbles the ball, which strikes the ground and bounces high in the air. B2 receives the ball while off the ground and returns to the ground out of bounds (a) in advance of the spot of the fumble or (b) behind the spot of the fumble. **RULING:** (a) Team A's ball at the spot of the fumble. (b) Team A's ball at the spot where the ball crossed the sideline (Rules 4-2-4-d and 7-2-4). [Cited by 4-2-4-d, 7-2-4-a]

At Rest

ARTICLE 5. When a backward pass or fumble comes to rest inbounds and no player attempts to secure it, the ball becomes dead and:

- a. If in advance of the spot of the pass/fumble, the ball belongs to the passing/fumbling team at the spot of the pass/fumble.
- b. If behind the spot of the pass/fumble, the ball belongs to the passing/fumbling team at the dead-ball spot.

SECTION 3. Forward Pass

Legal Forward Pass

ARTICLE 1. Team A may make one forward pass during each scrimmage down before team possession changes, provided the pass is thrown from a point in or behind the neutral zone (**A.R. 7-3-1:I-II**).

Approved Ruling 7-3-1

- I. 1/10 @ A-25. QB A12 is in shotgun formation and slot receiver A80, who is lined up to the wide side of the field, goes in motion toward A12 before the snap. At the snap A80 heads toward A12 to run the jet sweep. A12 flips the ball up into the air and A80 (a) catches the ball as they cross in front of A12 and A80 turns upfield and is out of bounds at the A-40, or (b) muffs the ball and the ball drops to the ground. **RULING:** The short flip of the ball by A12 is considered a legal forward pass unless it is clearly and

obviously thrown backward: (a) Completed forward pass to A80 and the run upfield results in a first down for the offense. (b) When the ball strikes the ground, it is ruled an incomplete forward pass and the play is dead. [Cited by 7-3-1]

- II. 1/10 @ A-25. QB A12 is in shotgun formation and slot receiver A80, who is lined up to the wide side of the field, goes in motion toward A12 before the snap. At the snap A80 heads toward A12 to run the jet sweep. A12 flips the ball up into the air but it is a fake jet sweep and A80 passes by and does not touch the ball. A12 catches the ball and: (a) runs upfield and is out of bounds at the A-40, or (b) then throws a forward pass to A88 who makes the catch at the A-40 and is downed at that spot. **RULING:** The short flip of the ball by A12 is considered a legal forward pass unless it is clearly and obviously thrown backward: (a) The catch of the forward pass by A12 is legal and the advance results in a first down for the offense. (b) The catch of the forward pass by A12 is legal, but A12's pass to A88 is the second forward pass during the same down and is an Illegal Forward Pass as per Rule 7-3-2-d. [Cited by 7-3-1, 7-3-2-d]

Illegal Forward Pass

ARTICLE 2. A forward pass is illegal if:

- a. It is thrown by a Team A player whose entire body is beyond the neutral zone when the ball is released.
- b. It is thrown by a Team B player.
- c. It is thrown after team possession has changed during the down.
- d. It is the second forward pass during the same down. (**A.R. 7-3-1:II**)
- e. It is thrown from in or behind the neutral zone after a ball carrier's entire body and the ball have been beyond the neutral zone.

PENALTY – [a-e] Five yards from the spot of the foul; also loss of down if by Team A before team possession changes during a scrimmage down (A.R. 3-4-3:IV) [S35 and S9: IFP].

- f. The forward passer, to conserve time, throws the ball directly to the ground (1) after the ball has already touched the ground; or (2) not immediately after controlling the ball.
- g. The forward passer, to conserve time, throws the ball forward into an area where there is no eligible Team A receiver other than themselves (**A.R. 7-3-2:II-VII**).
- h. The forward passer, to conserve yardage, throws the ball forward into an area where there is no eligible Team A receiver other than themselves (**A.R. 7-3-2:I**).

[Exception: It is not a foul if the forward passer is or has been outside the tackle box and throws the ball so that it crosses or lands beyond the neutral zone or neutral zone extended (Rule 2-19-3) or would have crossed the neutral zone if not touched by Team B (**A.R. 7-3-2:VIII-XI, XIII**).

This applies only to the player who controls the snap or the resulting backward pass and does not relinquish possession to another player before throwing the forward pass.]

PENALTY – [f-h] Loss of down at the spot of the foul [S36 and S9: ING]

Approved Ruling 7-3-2

- I. Quarterback A10, who is not outside the tackle box and is attempting to save yardage, intentionally throws a desperation forward pass that falls incomplete where there is no eligible Team A receiver. **RULING:** Intentional grounding. Penalty — Loss of down at the spot of the foul. The clock starts on the snap (Rule 3-3-2-d-4) unless Rule 3-4-4 applies. [Cited by 7-3-2-h]
- II. Late in either half with more than one minute remaining, A10 is unable to locate an open receiver. To conserve time, they throw a forward pass that is incomplete where there is no eligible Team A player. **RULING:** Illegal forward pass, intentional grounding. Penalty — Loss of down at the spot of the foul. The clock will start on the ready-for-play signal (Rule 3-3-2-e-14 and 3-4-3). [Cited by 3-3-2-e-14, 7-3-2-g]
- III. On third down near the end of either half, potential field goal holder A4 muffs the snap and A4 or potential kicker A3 recovers the ball and immediately throws it forward to the ground. **RULING:** Illegal forward pass for intentional grounding; not a valid attempt to conserve time. Penalty — Loss of down at the spot of the foul. 10-second runoff option for Team B (Rule 3-4-4). Clock starts on the ready-for-play signal (Rules 3-3-2-e-14 and 3-4-3) if the 10-second runoff is accepted. [Cited by 3-3-2-e-14, 7-3-2-g]
- IV. The ball is snapped over the head of quarterback A12, who is in the "shotgun" formation. A12 recovers the ball and immediately throws it forward to the ground. **RULING:** Illegal forward pass for intentional

- grounding; not a valid attempt to conserve time. Penalty — Loss of down at the spot of the foul. Clock starts on the ready-for-play signal (Rules 3-3-2-e-14 and 3-4-3). [Cited by 3-3-2-e-14, 7-3-2-g]
- V. On third down near the end of the half, A1 muffs the snap. A1 or A4 catches the muffed ball and immediately throws it forward into the ground. **RULING:** Legal play. [Cited by 3-3-2-e-14, 7-3-2-g]
- VI. On third down near the end of the half, A1 – positioned seven yards behind the snapper – catches the snap and immediately throws the ball forward to the ground. **RULING:** Legal play. [Cited by 3-3-2-e-14, 7-3-2-g]
- VII. With seconds remaining in a half and the ball ready for play, Team A quickly lines up and the ball is legally snapped to quarterback A12, who throws the ball forward directly to the ground. Team A's formation was not legal at the snap. When the ball becomes dead, two seconds show on the game clock. **RULING:** Illegal formation. Penalty — Five yards from the previous spot. The clock starts on the snap. [Cited by 3-3-2-e-14, 7-3-2-g]
- VIII. Quarterback A10 sprints toward a sideline and is outside the tackle box when they throw a legal forward pass that is batted down by a defensive lineman and lands behind the neutral zone. **RULING:** Legal play. Without the batting the ball would have landed beyond the neutral zone, so A10 has satisfied the spirit of the rule. [Cited by 7-3-2-h]
- IX. Third and five at the A-40. QB A12 drops back in the pocket to pass. Under a heavy rush they throw a backward pass to back A22 who carries the ball outside the tackle box. About to be tackled, A22 at the A-35 throws a forward pass that crosses the neutral zone and lands in an area 20 yards away from the nearest Team A eligible receiver. **RULING:** Foul, intentional grounding. The tackle-box rule exception applies only to the player who controls the snap or the resulting backward pass. Loss of down at the spot of the foul. Fourth and 10 at the A-35 (Rule 7-3-2-h Exception). [Cited by 7-3-2-h]
- X. Quarterback A12 is in a shotgun formation. They muff the backward pass from the snapper and the ball is picked up by A63 inside the tackle box. Under a heavy rush, A63 gets outside the tackle box and throws the ball incomplete beyond the line of scrimmage. **RULING:** Legal play. A63 controlled the backward pass that resulted from the snap (Rule 7-3-2-h Exception). [Cited by 7-3-2-h]
- XI. Second and 10 at the A-40. In a shotgun formation A11 takes the backward pass from the snapper and hands the ball off to back A44. A44 takes a few steps toward the line of scrimmage and then throws a backward pass to A11, who is still inside the tackle box. Avoiding tacklers, A11 scrambles outside the tackle box, and unable to find an open receiver, at the A-35 they throw the ball toward an area where there are no eligible receivers, and it lands out of bounds beyond the neutral zone. **RULING:** Illegal forward pass. Loss of down at the A-35; third and 15. A11 loses the right to throw the ball away legally because they relinquish possession before passing it. [Cited by 7-3-2-h]
- XII. Third and 10 at the A-30. Quarterback A11 drops back to pass. About to be tackled at the A-20, they throw the ball forward to an area where there are no eligible receivers. Tackle A77 catches the pass at the A-28 and is tackled at the A-32. **RULING:** Illegal forward pass; loss of down at the spot of the pass. Fourth and 20 at the A-20. This is "intentional grounding" since A11 throws the ball into an area where there are no eligible Team A receivers. Note that this is not illegal touching by A77, because the rule for illegal touching applies only to a legal forward pass (Rule 7-3-11). [Cited by 7-3-11]
- XIII. Quarterback A11 drops back to pass and scrambles outside the tackle box. They fumble the ball, which bounces back up into their hands. They then pass the ball forward, and it lands beyond the neutral zone in an open area where there is no eligible receiver with an opportunity to make a catch. **RULING:** Legal play, since A11 did not relinquish possession to another player. [Cited by 7-3-2-h]

Eligibility to Touch Legal Forward Pass

ARTICLE 3. a. Eligibility rules apply during a down when a legal forward pass is thrown.

b. All Team B players are eligible to touch or catch a pass.

c. When the ball is snapped, the following Team A players are eligible:

1. Each lineman who is on the end of their scrimmage line and who is wearing a number other than 50 through 79.
2. Each back wearing a number other than 50 through 79.

d. An eligible Team A player loses their eligibility when they go out of bounds (Rule 7-3-4) (**A.R. 7-3-9:III**).

Eligibility Lost by Going Out of Bounds

ARTICLE 4. No eligible Team A receiver who goes out of bounds and returns in bounds during a down shall touch a legal forward pass while in the field of play or end zones or while airborne until it has been touched by an opponent or official. (**A.R. 7-3-4:I-II and IV**)

[Exception: This does not apply to an originally eligible Team A player who immediately returns inbounds after going out of bounds due to contact by an opponent (**A.R. 7-3-4:III**)]. If they touch the pass before returning in bounds, it is an incomplete pass (Rule 7-3-7) and not a foul for illegal touching.

PENALTY – Loss of down at the previous spot [S16 and S9: ITP].

Approved Ruling 7-3-4

- I. Eligible A88 voluntarily goes out of bounds, returns inbounds, and is the first player to touch the legal forward pass. This touching by A88 occurs in Team B's end zone. **RULING:** Illegal touching. Penalty — Loss of down at the previous spot. [Cited by 7-3-4]
- II. Eligible A88 voluntarily goes out of bounds during a down in which a legal forward pass is thrown. They return to the field of play inbounds but do not touch the ball and are held by an opponent before the ball is touched by any player. **RULING:** Not pass interference – A88 is not eligible to catch a legal forward pass. Penalty — 10 yards from the previous spot and automatic first down. [Cited by 7-3-4]
- III. Wide receiver A88 is blocked out of bounds by B1 and then runs 20 yards before returning to the field of play. A88 catches a legal pass in Team B's end zone. **RULING:** Foul for illegal touching due to A88's failure to return inbounds immediately. Penalty — Loss of down at the previous spot. [Cited by 7-3-4]
- IV. Eligible receiver A44 is running a pass pattern near the sideline. As a legal forward pass comes toward them, they accidentally step on the sideline, leap, muff the pass into the air while airborne, return to the ground inbounds, grab the ball and land on their knees inbounds with the ball firmly in their possession. **RULING:** Incomplete pass. A44 first touched the ball while airborne and thus out of bounds since they had not established in bounds (Rule 2-27-15). [Cited by 7-3-4]

Eligibility Gained or Regained

ARTICLE 5. When a Team B player or an official touches a legal forward pass, all players become eligible. (**A.R. 7-3-5:I**)

Approved Ruling 7-3-5

- I. Team B touches the legal forward pass near a sideline while originally eligible A1 is out of bounds. A1 comes inbounds and touches the pass. **RULING:** Legal play. Touching by Team B made all players eligible during the remainder of the down. [Cited by 7-3-5]

Complete Pass

ARTICLE 6. Any forward pass is complete when caught by a player of the passing team who is inbounds, and the ball continues in play unless completed in the opponent's end zone or the pass has been caught simultaneously by opposing players. If a forward pass is caught simultaneously by opposing players inbounds, the ball becomes dead and belongs to the passing team (Rules 2-4-3 and 2-4-4). (**A.R. 2-4-3:III**) (**A.R. 7-3-6:I-VIII**)

Approved Ruling 7-3-6

- I. Two opposing players receive a legal forward pass while both are off the ground, and both players return to the ground inbounds at the same time. **RULING:** Simultaneous catch; the ball is awarded to the passing team (Rule 2-4-4). [Cited by 2-4-4] [Cited by 7-3-6]
- II. Two opposing players receive a ball while both are off the ground, and one player returns to the ground inbounds before the other. **RULING:** No simultaneous catch. The legal forward pass is completed or intercepted by the player who first returned to the ground (Rule 2-4-4). [Cited by 2-4-4, 7-3-6]
- III. An inbounds airborne player receives a legal forward pass. While still in the air, they are tackled by an opponent and obviously held for a moment before being carried in any direction. They then land inbounds or out of bounds with the ball. **RULING:** Completed pass. The ball is dead at the yard line where the receiver/interceptor was held in a manner that prevented them from immediately returning to the ground (Rule 4-1-3-p). [Cited by 4-1-3-p, 7-3-6]

- IV. Airborne A80 receives a legal forward pass at their 30-yard line. While still in the air, they are tackled by B40 and driven forward to Team A's 34-yard line, where they are downed. **RULING:** Team A's ball at its 34-yard line (Rule 5-1-3-a). [Cited by 7-3-6]
- V. Airborne A80 receives a legal forward pass at their 30-yard line. While still in the air, they are tackled by B40 and driven backward to Team A's 26-yard line, where the ball becomes dead. **RULING:** Team A's ball at the 30-yard line (Rule 5-1-3-a Exception). [Cited by 5-1-3-a-2, 7-3-6]
- VI. A86 is legally blocked out of bounds by B18 at Team B's two-yard line. A86, while attempting an immediate return to the field of play, leaps from out of bounds and is airborne as they receive A16's legal forward pass. They land in Team B's end zone with the ball in their grasp. **RULING:** Incomplete pass. A86 did not establish in bounds before touching the pass, and hence they were still out of bounds (Rule 2-27-15). [Cited by 7-3-6]
- VII. B33 leaps from in bounds and is airborne as they receive Team A's legal forward pass. They complete the interception by landing (a) in the field of play or (b) in Team B's end zone, and are then tackled. **RULING:** B33 is a ball carrier until they lose player possession or the ball becomes dead by rule. (a) First and 10 for Team B. (b) Touchback. (Rules 4-1-3-c, 4-2-3-a, 5-1-1-e and 7-3-4). [Cited by 7-3-6]
- VIII. While airborne and in bounds, eligible receiver A89 touches a forward pass when they propel it toward (a) eligible receiver A80, who catches the pass; or (b) B27, who intercepts the pass. **RULING:** Legal play, and the ball remains live in both (a) and (b). A89 has batted a forward pass (Rules 2-4-3, 2-11-3 and 9-4-1-a). [Cited by 7-3-6]
- IX. Airborne receiver A85 grasps a forward pass and in the process of going to the ground, first contacts the ground with their left foot as they fall to the ground inbounds. Immediately upon A85 hitting the ground, the ball comes loose and touches the ground. **RULING:** Incomplete pass. An airborne receiver must maintain control of the ball while going to the ground in the process of completing a catch. [Cited by 2-4-3-b]
- X. Airborne receiver A85 grasps a forward pass and in the process of going to the ground, first contacts the ground with their left foot as they fall to the ground inbounds. Immediately upon A85 hitting the ground, the ball comes loose but never touches the ground before they regain control. **RULING:** Catch. If the receiver is inbounds and is going to the ground and loses control, as long as the player remains inbounds and the ball never touches the ground, it is a completed pass. [Cited by 2-4-3-b]
- XI. Airborne receiver A85 grasps a forward pass and in the process of going to the ground, first contacts the ground with their left foot inbounds as they fall to the ground out of bounds. Immediately upon A85 hitting the ground out of bounds, the ball comes loose. **RULING:** Incomplete pass regardless of whether or not the ball hits the ground because the receiver is out of bounds. [Cited by 2-4-3-b]
- XII. Receiver A85 stretches out at the Team B two-yard line and grasps a forward pass and is going to the ground on their own as they are attempting to complete the catch. As A85 falls to the ground in the end zone, the ball immediately comes loose and falls to the ground. **RULING:** Incomplete pass. Any receiver going to the ground on their own in the process of making a catch must maintain control of the ball when they hit the ground. [Cited by 2-4-3-b]
- XIII. Receiver A85 is airborne and in bounds in the end zone and grasps a forward pass, but while airborne they are hit by a defender, which causes A85 to fall to the ground. Immediately upon A85 hitting the ground, the ball comes loose and strikes the ground. **RULING:** Incomplete pass. An airborne receiver contacted before completing all the requirements of a catch must still maintain control of the ball after hitting the ground. [Cited by 2-4-3-b]
- XIV. Eligible A80 is airborne when they receive a legal forward pass. They grasp the ball firmly in their hands, and as they are returning toward the ground, the nose of the football touches the ground before any part of their body. A80 retains their firm control of the ball and it does not move during this action. A80's knees then touch the ground and they maintain control of the ball. **RULING:** Completed pass. [Cited by 2-4-3-b]
- XV. Eligible A80 is airborne near the sideline when they receive a legal forward pass. As they come to the ground facing the field of play, their toe (a) clearly drags the ground inbounds before they fall out of bounds; (b) touches the ground inbounds and then their heel comes down on the sideline in a continuous motion. They maintain firm control of the ball in both cases. **RULING:** (a) Complete pass. (b) Incomplete pass. The continuous toe-heel touching is part of a single process and by interpretation they have landed out of bounds, thus not executing a catch. [Cited by 2-4-3-b]

Incomplete Pass

- ARTICLE 7. a. Any forward pass is incomplete if the ball is out of bounds by rule (Rule 4-2-3) or if it touches the ground when not firmly controlled by a player. It also is incomplete when a player leaves their feet and receives the pass but first lands on or outside a boundary line, unless their progress has been stopped in the field of play or end zone (Rule 4-1-3-p). **(A.R. 2-4-3:III)**
(A.R. 7-3-7:I)
- b. When a legal forward pass is incomplete, the ball belongs to the passing team at the previous spot.
- c. When an illegal forward pass is incomplete, the ball belongs to the passing team at the spot of the pass (**Exception:** If Team B declines the penalty for an illegal pass thrown from the end zone, the ball shall next be put in play at the previous spot.) **(A.R. 7-3-7:II-III)**

Approved Ruling 7-3-7

- I. A player touches a legal forward pass (a) while they are contacting a boundary line; (b) while airborne after having leaped from out of bounds. **RULING:** (a) and (b). The ball is out of bounds, the pass is incomplete, and the down counts. The player loses their eligibility when they go out of bounds (Rules 2-27-15, 4-2-3-a and 7-3-3). [Cited by 7-3-7-a]
- II. Fourth and nine on Team A's six-yard line. A1 intentionally grounds a forward pass in their end zone to save loss of yardage. **RULING:** Team B may accept the penalty for a safety. If they decline the penalty, it is Team B's ball, first and goal on the six-yard line. [Cited by 7-3-7-c]
- III. Third and nine on Team A's six-yard line. A1 throws a second forward pass from their end zone. B2 intercepts and is downed on Team A's 20-yard line. **RULING:** Team B may accept the penalty which results in a safety or take the result of the play, retaining the ball for a first down on Team A's 20-yard line. [Cited by 7-3-7-c]

Illegal Contact and Pass Interference

- ARTICLE 8. a. During a down in which a legal forward pass crosses the neutral zone, illegal contact by Team A and Team B players is prohibited from the time the ball is snapped until it is touched by any player or an official **(A.R. 7-3-8:II)**.
- b. Offensive pass interference is contact by a Team A player beyond the neutral zone that interferes with a Team B player during a legal forward pass play in which the forward pass crosses the neutral zone. It is the responsibility of the offensive player to avoid the opponents. It is not offensive pass interference **(A.R. 7-3-8:IV-VI, X, XIII, XV and XVI)**:
1. When, after the snap, a Team A ineligible player immediately charges and contacts an opponent at a point not more than one yard beyond the neutral zone and maintains the contact for no more than three yards beyond the neutral zone. **(A.R. 7-3-10:II)**
 2. When two or more eligible players are making a simultaneous and bona fide attempt to reach, catch or bat the pass. Eligible players of either team have equal rights to the ball. **(A.R. 7-3-8:IX)**
 3. When the pass is in flight and two or more eligible players are in the area where they might receive or intercept the pass and an offensive player in that area impedes an opponent, and the pass is not catchable.

PENALTY – 15 yards from the previous spot [S33: OPI].

- c. Defensive pass interference is contact beyond the neutral zone by a Team B player whose intent to impede an eligible opponent is obvious and could prevent the opponent the opportunity of receiving a catchable forward pass. When in question, a legal forward pass is catchable. Defensive pass interference occurs only after a legal forward pass is thrown. **(A.R. 7-3-8:VII, VIII, XI and XII)**.

It is not defensive pass interference **(A.R. 7-3-8:III)** **(A.R. 7-3-9:III)**:

1. When, after the snap, opposing players immediately charge and establish contact with opponents at a point that is within one yard beyond the neutral zone.

2. When two or more eligible players are making a simultaneous and bona fide attempt to reach, catch or bat the pass. Eligible players of either team have equal rights to the ball. (**A.R. 7-3-8:IX**)
3. When a Team B player legally contacts an opponent before the pass is thrown. (**A.R. 7-3-8:III and X**)
4. When there is contact by a Team B player that otherwise would be pass interference during a down in which a Team A potential kicker, from scrimmage kick formation, simulates a scrimmage kick by throwing the ball high and deep.

PENALTY – Team A’s ball at the spot of the foul, first down, if the foul occurs fewer than 15 yards beyond the previous spot. If the foul occurs 15 or more yards beyond the previous spot, Team A’s ball, first down, 15 yards from the previous spot [S33: DPI].

When the ball is snapped on or inside the Team B 17-yard line and outside the Team B two-yard line and the spot of the foul is on or inside the two-yard line, the penalty from the previous spot shall place the ball at the two-yard line, first down. (A.R. 7-3-8:XIV)

No penalty enforced from outside the two-yard line may place the ball inside the two-yard line (Exception: On the try when the snap is on or inside the three-yard line, Rule 10-2-5-b).

If the previous spot was on or inside the two-yard line, first down halfway between the previous spot and the goal line (Rule 10-2-6 Exception).

Approved Ruling 7-3-8

- I. B33, defending against a legal forward pass beyond the neutral zone, has their back to the ball and is waving their arms in the face of eligible A88, but does not make contact. **RULING:** No foul. There is no foul for defensive pass interference if there is no contact. [Cited by 7-3-9-f]
- II. Wide receiver A80, 15 yards beyond the neutral zone, turns their back toward the neutral zone. The forward passer throws the ball high over A80’s hands, which are extended above their head. The ball is overthrown and beyond the receiver (uncatchable pass) when B2 pulls A80 down by the face mask. **RULING:** Personal foul (Rule 9-1-12-a), not pass interference. Penalty — 15 yards from the previous spot. First and 10 for Team A. Flagrant offenders shall be disqualified. [Cited by 7-3-8-a]
- III. A83, a wide receiver 10 yards from the nearest interior lineman, slants toward the middle of the field. Before the ball is thrown, B1, a back, legally blocks them and knocks them down. **RULING:** Legal unless the block was below the waist (Rule 9-1-6). [Cited by 7-3-8-c-3, 7-3-8-c]
- IV. At the snap, A88 is on the end of the line of scrimmage 10 yards from the tackle position and A44 is in the backfield, four yards to their inside. Just before the Team A forward passer releases the ball, A88 contacts B1 five yards beyond the neutral zone. The pass is thrown to A44, who has moved in front and to the outside of the spot where A88 had contacted B1. **RULING:** Team A foul, offensive pass interference. Penalty — 15 yards from previous spot. [Cited by 7-3-8-b]
- V. Before the ball is thrown, wide receiver A88 moves four yards downfield directly toward and in front of the defender, B1. At this spot, B1 pushes A88, who then uses their hands to contact B1. **RULING:** Team A foul, offensive pass interference, if the legal forward pass is beyond the neutral zone. Penalty — 15 yards from previous spot. [Cited by 7-3-8-b]
- VI. Before the ball is thrown, wide receiver A88 slants to the inside where linebacker B1 attempts to block them. A88 uses their hands to shove B1 away. **RULING:** Team A foul, offensive pass interference if the legal forward pass crosses the neutral zone. If B1’s initial contact was below the waist, Team B also has fouled and the live-ball fouls offset. [Cited by 7-3-8-b]
- VII. A88, a spread receiver, runs a 10-yard route and cuts 90 degrees to the sideline. After the ball is thrown, B2 contacts A88 with a tackle, block, grasp or push before A88 touches the ball, a catchable forward pass. **RULING:** Team B foul, defensive pass interference. Penalty — Spot foul and first down. [Cited by 7-3-8-c]
- VIII. A80, a tight end, runs 10 yards into the secondary and cuts toward the goal posts. B1 is one step behind and to the outside when they recover. After the legal forward pass has been thrown, B1 contacts A80 with a tackle, block, grasp or push as the ball goes over A80’s outstretched hands. **RULING:** Team B foul for defensive pass interference. Penalty — Spot foul and a first down if infraction occurs less than 15 yards from previous spot; 15-yard penalty from the previous spot and a first down if the foul is more than 15 yards beyond the neutral zone. [Cited by 7-3-8-c]

- IX. A88 and B2 are running closely together before or after the ball has been thrown. Either A88 or B2 or both fall when their feet become entangled. Neither player was tripped intentionally. **RULING:** No foul. [Cited by 7-3-8-b-2, 7-3-8-c-2]
- X. Before the pass is thrown, wide receiver A88 and defender B1 are running shoulder to shoulder and side by side 15 yards beyond the neutral zone. A88 is nearest to the sideline, and B1 is nearest to the hash mark. A88 breaks to the inside. B1 does not move, and A88 collides with them. **RULING:** No foul because the ball has not been thrown. [Cited by 7-3-8-b, 7-3-8-c-3]
- XI. Wide receiver A88 and defender B1 are running shoulder to shoulder and side by side 15 yards beyond the neutral zone. A88 is nearest to the sideline, and B1 is nearest to the hash mark. A legal forward pass is thrown toward the goal post. While the ball is in the air, A88 breaks to the inside toward the catchable forward pass. B1 does not move and makes no attempt to go for the pass, and A88 collides with them. **RULING:** Team B foul, defensive pass interference. Penalty — 15 yards from previous spot and first down. [Cited by 7-3-8-c]
- XII. A44, a slot back, runs a pattern 25 yards downfield toward the goal line pylon. B1, a safety, is positioned between A44 and the pylon when the ball is thrown. B1 obviously reduces their speed and collides with A44 before the catchable ball touches the ground. **RULING:** Team B foul, defensive pass interference. Penalty — 15 yards from the previous spot and first down. [Cited by 7-3-8-c]
- XIII. A80, a tight end, moves across the formation on a pass pattern at a depth of 25 yards where they contact B1, a safety, before or after the ball has been thrown. A88, a wide receiver, positioned on the opposite side from the tight end at the snap, crosses behind the contact of A80 and B1 and catches the legal forward pass. **RULING:** Team A foul, offensive pass interference. Penalty — 15 yards from previous spot. [Cited by 7-3-8-b]
- XIV. Fourth and goal for Team A on Team B's five-yard line. Team A's legal forward pass is incomplete, but Team B interfered on its one-yard line or in its end zone. **RULING:** First and goal for Team A on Team B's two-yard line. [Cited by 7-3-8 Penalty]
- XV. A80 and B60 are attempting to catch a forward pass thrown toward A80's position, which is beyond the neutral zone. The pass is high and ruled uncatchable. As the ball passes overhead, A80 pushes B60 in the chest. **RULING:** Not offensive pass interference. [Cited by 7-3-8-b]
- XVI. On a legal forward pass beyond the neutral zone, A80 and B60 are attempting to catch the pass thrown to A80's position. A14, who is not attempting to catch the pass, blocks B65 downfield, either before the pass is thrown or while the uncatchable pass is in flight. **RULING:** Team A foul, offensive pass interference. Penalty — 15 yards from the previous spot. [Cited by 7-3-8-b]

Pass Interference: Summary

- ARTICLE 9. a. Either Team A or Team B legally may interfere with opponents behind the neutral zone.
- b. Players of either team legally may interfere beyond the neutral zone after the pass has been touched. **(A.R. 7-3-9:I)**
- c. Defensive players legally may contact opponents who have crossed the neutral zone if the opponents are not in a position to receive a catchable forward pass.
1. Those infractions that occur during a down in which a forward pass crosses the neutral zone are pass interference infractions only if the receiver had the opportunity to receive a catchable forward pass.
 2. Those infractions that occur during a down in which a forward pass does not cross the neutral zone are Rule 9-3-4 infractions and the penalty is enforced from the previous spot.
- d. Pass interference rules apply only during a down in which a legal forward pass crosses the neutral zone (Rules 2-19-3 and 7-3-8). **(A.R. 7-3-9:II)**.
- e. Contact by Team B with an eligible receiver involving a personal foul that interferes with the reception of a catchable pass may be ruled either as pass interference or as a personal foul with the 15-yard penalty enforced from the previous spot. Rule 7-3-8 is specific about contact during a pass. However if the interference involves an act that ordinarily would result in disqualification, the fouling player is disqualified from the game.
- f. Physical contact is required to establish interference. **(A.R. 7-3-8:I)**

- g. Each player has territorial rights, and incidental contact is ruled under "attempt to reach ... the pass" in Rule 7-3-8. If opponents who are beyond the line collide while moving toward the pass, a foul by one or both players occurs only if intent to impede the opponent is obvious. It is pass interference only if a catchable forward pass is involved.
- h. Pass interference rules do not apply after the pass has been touched anywhere inbounds by an inbounds player or has touched an official. If an opponent is fouled, the penalty is for the foul and not pass interference. **(A.R. 7-3-9:I)**
- i. After the pass has been touched, any player may execute a legal block during the remaining flight of the pass.
- j. Tackling or grasping a receiver or any other intentional contact before the receiver touches the pass is evidence that the tackler is disregarding the ball and is therefore illegal.
- k. Tackling or running into a receiver when a forward pass obviously is underthrown or overthrown is disregarding the ball and is illegal. This is not pass interference but a violation of Rule 9-1-12-a, which carries a penalty of 15 yards from the previous spot plus a first down. Flagrant offenders shall be disqualified.

Approved Ruling 7-3-9

- I. A legal forward pass beyond the neutral zone is tipped or muffed by an eligible receiver of either team or glances off an official. Then, while the pass is still in flight, either Team A or Team B holds an eligible opponent who is beyond the neutral zone. **RULING:** Interference rules do not apply after the pass has been touched. Penalize as a foul during a loose ball. Penalty — 10 yards from the previous spot (Rule 9-3-4). [Cited by 7-3-9-b, 7-3-9-h]
- II. On a legal forward pass behind the neutral zone, eligible A1 "has position" on B1 and is about to touch the pass when B1 pushes A1 and the pass is incomplete. **RULING:** Legal. Interference rules do not apply behind the neutral zone (Rules 7-3-9-d, 9-1-5 Exception 4 and 9-3-5 Exception 5). [Cited by 7-3-9-d]
- III. Running a pattern near the sideline, end A88 touches the sideline just before a defender jumps into them and bats the ball to the ground. **RULING:** Not defensive pass interference. A88 became ineligible when they stepped out of bounds (Rule 7-3-3). [Cited by 7-3-3-d, 7-3-8-c]

Ineligible Receiver Downfield

ARTICLE 10. No originally ineligible receiver shall be or have been more than three yards beyond the neutral zone until a forward passer throws a legal forward pass that crosses the neutral zone. A player is in violation of this rule if any part of their body is beyond the three-yard limit (**Exception:** If the passer is legally throwing the ball away and the ball lands near or beyond the sideline). **(A.R. 7-3-10:I and III).**

PENALTY – Five yards from the previous spot [S37: IDP].

Approved Ruling 7-3-10

- I. Ineligible lineman A70 runs more than three yards beyond the neutral zone and does not make contact with an opponent. They circle toward the flank and returns across the neutral zone before A10 throws a legal forward pass that crosses the neutral zone. **RULING:** Ineligible downfield. Penalty — Five yards from the previous spot. [Cited by 7-3-10]
- II. Ineligible lineman A70 makes contact with an opponent within one yard of the neutral zone. A70 drives B4 more than three yards beyond the neutral zone and then circles back across the neutral zone before A1 throws a legal forward pass that crosses the neutral zone. **RULING:** Team A foul, offensive pass interference. Penalty — 15 yards from the previous spot (Rule 7-3-8-b). [Cited by 7-3-8-b-1]
- III. First and 10 at the A-37. Ineligible lineman A70 avoids defensive linemen after the snap and starts downfield. When the passer releases the ball, the top of A70's helmet is penetrating the plane of the A-40. The pass crosses the neutral zone and falls incomplete at the A-39. **RULING:** Foul, ineligible receiver downfield. Some part of A70's body was more than three yards beyond the neutral zone when the pass was released. [Cited by 7-3-10]

Illegal Touching

ARTICLE 11. No originally ineligible player while inbounds may intentionally touch a legal forward pass until it has touched an opponent or an official. (A.R. 5-2-3:I) (A.R. 7-3-2:XII) (A.R. 7-3-11:I-II)

PENALTY – Five yards from the previous spot, loss of down [S16 and S9: ITP].

Approved Ruling 7-3-11

- I. Late in the half, quarterback A10, who has not been outside the tackle box, throws a desperation pass to intentionally save yardage that falls incomplete after ineligible A58 touches the ball in an attempt to catch it. **RULING:** Foul for intentional grounding. No foul for illegal touching since the pass is illegal. Penalty — Loss of down at the spot of the pass. The clock starts on the snap (Rules 3-3-2-d-4 and 7-3-2-h). Rule 3-4-4 applies if less than **two minutes** remains on the game clock. If time expires in the quarter, the quarter is not extended. [Cited by 7-3-11]
- II. Team A snaps on its 10-yard line. A10 retreats and then passes forward to ineligible A70 who, while in their end zone, (a) touches the ball as they attempt to catch the pass, and the pass is incomplete; (b) catches the pass and is downed in the end zone; or (c) catches the pass and is downed after having advanced to their three-yard line. **RULING:** (a) Team B may accept the five-yard penalty from the previous spot that includes loss of down, so the down will count. (b) The ball is dead in the end zone with impetus by Team A, and Team B may accept the safety or the penalty at the previous spot with loss of down. (c) Five-yard penalty from the previous spot and loss of down. The down counts if the penalty is declined; the dead-ball spot might be deemed more advantageous to Team B than the penalty. [NOTE: (a), (b) and (c) could be intentional grounding depending on the location of an eligible Team A player or the location of A10 when the ball is thrown] (Rule 10-1-1-b). If intentional grounding is warranted, there is no illegal touching. [Cited by 7-3-11]

Team B personal foul and unsportsmanlike conduct during legal forward pass play

ARTICLE 12. Penalties for personal fouls and unsportsmanlike conduct by Team B during a completed legal forward pass play are enforced at the end of the last run when it ends beyond the neutral zone. If the pass is incomplete or intercepted, or if there is a change of team possession during the down, the penalty is enforced at the previous spot (Rule 9-1 Penalty). (A.R. 7-3-12:I) (A.R. 9-1-2:III)

Approved Ruling 7-3-12

- I. A11 throws a forward pass intended for A88. During the play defensive end B88 is flagged for a head-slap to tackle A79. The pass to A88 is (a) complete for a 10-yard gain to the A-30 where A88 is tackled; (b) incomplete or intercepted. **RULING:** (a) The penalty is enforced at the end of the of run, which is the A-30; first and 10 for Team A at the A-45. (b) The penalty is enforced at the previous spot, first and 10 for Team A at the A-35 (Rule 9-1 Penalty). [Cited by 10-2-2-e, 7-3-12]
- II. Second and ten at the A-20. A11 throws a forward pass intended for A88. During the pass, defensive end B88 is flagged for unsportsmanlike conduct. The pass to A88 is (a) complete for a 10-yard gain to the A-30 where A88 is tackled. (b) incomplete or intercepted. **RULING:** (a) The penalty is enforced at the end of the run, which is the A-30; first and 10 for Team A at the A-45. (b) The penalty is enforced at the previous spot, first and 10 for Team A at the A-35 (Rule 9-2-1 Penalty).

RULE 8

Scoring

SECTION 1. Value of Scores

Scoring Plays

ARTICLE 1. The point value of scoring plays shall be: (A.R. 8-3-2:IX)

Touchdown	6 points
Field Goal	3 points
Safety (points awarded to opponent)	2 points
Touchdown during try	2 points
Field Goal during try	1 point
Safety during try (point awarded to opponent)	1 point

Forfeited Games

ARTICLE 2. The score of a forfeited game, or a suspended game that later results in a forfeiture, shall be: Offended Team – 1, Opponent – 0. However, if the offended team is ahead at the time of forfeit, the score stands (Rules 3-3-3-a, 3-3-3-b, and 9-2-3).

SECTION 2. Touchdown

How Scored

ARTICLE 1. A touchdown shall be scored when:

- a. A ball carrier advancing from the field of play has possession of a live ball when it penetrates the plane of the opponent's goal line. This plane extends beyond the pylons only for a player who touches the ground in the end zone or a pylon. (A.R. 2-23-1:I) (A.R. 8-2-1:I-IX)
- b. A player catches a forward pass in the opponent's end zone. (A.R. 5-1-3:I-II)
- c. A fumble or backward pass is recovered, caught, intercepted, or awarded in the opponent's end zone (*Exceptions:* Rules 7-2-2-a Exception 2, 7-2-5 and 8-3-2-d-5). (A.R. 8-2-1:X)
- d. A free kick or scrimmage kick is legally caught or recovered in the opponent's end zone. (A.R. 6-3-9:III)
- e. The referee awards a touchdown under the provisions of Rule 9-2-3 Penalty.

Approved Ruling 8-2-1

- I. Ball carrier A1, while attempting to score, strikes the pylon located on the right intersection of the goal line and sideline with their foot. They are carrying the ball in their right arm, which is extended over the sideline. **RULING:** Whether or not a touchdown is scored depends on the forward progress of the ball as related to the goal line when the ball becomes dead by rule (Rules 4-2-4-d and 5-1-3-a). [Cited by 2-9-2, 4-2-4-d, 8-2-1-a]
- II. Ball carrier A1, advancing in the field of play, becomes airborne at the two-yard line. Their first contact with the ground is out of bounds three yards beyond the goal line. The ball, in possession of the ball carrier, passes over the pylon. **RULING:** Touchdown (Rule 4-2-4-d). [Cited by 2-9-2, 4-2-4-d, 8-2-1-a]
- III. The ball, in possession of airborne ball carrier A21, crosses the sideline above the one-yard line, continues beyond the pylon and is then declared dead out of bounds in possession of A21. **RULING:** Ball is declared out of bounds at the one-yard line (Rules 2-12-1 and 4-2-4-d). [Cited by 2-9-2, 4-2-4-d, 8-2-1-a]

- IV. Quarterback A12 completes a forward pass to a teammate who is standing in Team B's end zone. (a) A12 is beyond the neutral zone when they release the ball. (b) The receiver is wearing uniform number 73. **RULING:** In (a) and (b) the result of the play is a touchdown. The penalty is completed according to Team B's options. [Cited by 2-9-2, 8-2-1-a]
- V. Ball carrier A22 dives for the goal line at the B-1. The ball in their possession (a) touches the pylon; (b) goes over the top of the pylon; (c) crosses the goal line inside the pylon. A22 then first contacts the ground out of bounds three yards beyond the goal line. **RULING:** (a), (b) and (c) Touchdown in all three. The ball in A22's possession has broken the plane of the goal line in all three scenarios. [Cited by 2-9-2, 4-2-4-d, 8-2-1-a]
- VI. Ball carrier A22 heads for the right-hand pylon at the goal line. At the B-2 they dive or are blocked into the air by an opponent. The ball in A22's right hand crosses the sideline at the B-1 and passes outside the pylon, and then A22 (a) touches the pylon with their foot or left hand; (b) first touches the ground out of bounds three yards beyond the goal line. **RULING:** (a) Touchdown. The goal-line plane is extended since A22 touches the pylon. (b) Not a touchdown. The goal-line plane is not extended because A22 did not touch either the pylon or the ground in the end zone. The ball is ruled out of bounds at the B-1. [Cited by 2-9-2, 4-2-4-d, 8-2-1-a]
- VII. Ball carrier A22 heads for the right-hand pylon at the goal line. The ball in their right hand crosses the extension of the goal line outside (i.e., to the right of) the pylon, and then A22 steps (a) on the goal line; (b) on the sideline inches short of the goal line. **RULING:** (a) Touchdown. The goal-line plane is extended because A22 touches the ground in the end zone. (b) Not a touchdown. The goal-line plane is not extended. The ball is ruled out of bounds at the crossing point. [Cited by 2-9-2, 4-2-4-d, 8-2-1-a]
- VIII. Ball carrier A22 heads for the right-hand pylon at the goal line. The ball is in their right hand. Their foot hits the pylon just before the ball crosses (a) the pylon or (b) the extension of the goal line just to the right (outside) of the pylon. **RULING:** (a) and (b) No touchdown in either case. Because the pylon is out of bounds, the ball is dead when A22's foot hits it. Thus in both cases the ball is dead before it crosses the goal line. [Cited by 2-9-2, 4-2-4-d, 8-2-1-a]
- IX. Ball carrier A1 is hit and their forward progress stopped inbounds near the goal line at the sideline to their right. When they are stopped they have the ball in their right hand extended beyond the goal line (a) inside the pylon; (b) outside the pylon. **RULING:** (a) Touchdown. The ball became dead when they extended it beyond the goal-line plane. (b) Not a touchdown, because no part of their body touches either the pylon or the end zone. In this case the goal-line plane is not extended. [Cited by 2-9-2, 4-2-4-d, 8-2-1-a]
- X. Ball carrier A33 is running toward the Team B goal line. A33 drops the ball at the one-yard line, circles through the end zone and runs to the team area, believing a touchdown has been scored. There is no touchdown signal by any official. The fumbled ball hits the ground just outside the goal line, rolls along the ground in the end zone, and is declared dead there when it comes to rest and no player attempts to recover it. **RULING:** When a fumble comes to rest inbounds and no player attempts to secure the ball in advance of the spot of the fumble, the ball belongs to the fumbling team at the spot of the fumble. Team A's ball at the 1-yard line. [Cited by 8-2-1-c]

SECTION 3. Try Down

How Scored

ARTICLE 1. If the try results in what would be a touchdown, safety or field goal under rules governing play at other times, the point or points shall be scored according to the point values in Rule 8-1-1 (A.R. 8-3-1:I-II) (A.R. 8-3-2:I-III and VI) (A.R. 10-2-5:X, XII-XV).

Approved Ruling 8-3-1

- I. During a try, after having obtained possession, Team B fumbles and Team A recovers in the Team B end zone. **RULING:** Team B can fumble after intercepting a pass, catching or recovering a fumble or recovering a backward pass. Touchdown. Award Team A two points (Rule 8-3-2-d-1). [Cited by 8-3-1]
- II. B19 is the first player beyond the neutral zone to touch Team A's blocked kick try when B19 muffs the in-flight kick in the end zone. A66 recovers in the end zone. **RULING:** Award Team A two points. [Cited by 8-3-1]

Opportunity to Score

ARTICLE 2. A try is an opportunity for either team to score one or two points while the game clock is stopped after a touchdown or in the third or subsequent extra period(s). It is a special interval in the game which, for purposes of penalty enforcement only, includes both a down and the “ready” period that precedes it.

- a. The ball shall be put in play by the team that scored a six-point touchdown. If a touchdown is scored during a down in which time in the fourth period expires or in the second possession series of an extra period, the try shall not be attempted unless the point(s) would affect the outcome of the game.

Exceptions:

1. If the scoring team is ahead by one or two points, they have the option to forego the try.
 2. The try shall not be attempted if the fourth period ends due to a running clock before the ball is snapped.
- b. The try, which is a scrimmage down, begins when the ball is declared ready for play.
 - c. The snap will be midway between the hash marks on the opponent’s three-yard line or from any other point on or between the hash marks on or behind the opponent’s three-yard line if the position of the ball is selected by the team designated to put the ball in play before the play clock is at 25 seconds or before any subsequent ready-for-play signal. The ball may be relocated after a Team B foul or a charged timeout to either team unless the timeout is preceded by a Team A foul or offsetting fouls (Rules 8-3-3-a and 8-3-3-c-1). **(A.R. 3-2-4:IV)**
 - d. The try ends when:
 1. Either team scores.
 2. The ball is dead by rule. **(A.R. 8-3-2:IV-VI)**
 3. An accepted penalty results in a score.
 4. A Team A loss-of-down penalty is accepted (Rule 8-3-3-c-2).
 5. Before a change of team possession, a Team A player fumbles and the ball is caught or recovered by any Team A player other than the fumbler. There is no Team A score. **(A.R. 8-3-2:VIII)**

Approved Ruling 8-3-2

- I. On a try attempt, B2 adds new impetus to a Team A fumble that is recovered in the Team B end zone by Team B. **RULING:** Safety, award Team A one point (Rules 8-3-1 and 8-5-1). [Cited by 8-3-1]
- II. On a try attempt, B2 kicks a Team A fumble into the Team B end zone where Team B recovers while grounded. **RULING:** Safety, one point for Team A, or Team A may accept the penalty for illegally kicking the ball (Rules 8-3-1 and 8-3-3-b-1) and repeat the down. [Cited by 8-3-1, 8-3-3-b-1]
- III. On a one-point try attempt, B2 blocks A1’s kick. The ball, which does not cross the neutral zone, is picked up by A2, and they advance the ball across Team B’s goal line. **RULING:** Award Team A two points (Rule 8-3-1). [Cited by 8-3-1]
- IV. On a one-point try attempt, Team A’s kick is blocked. A2 picks up the ball beyond the neutral zone in the field of play. **RULING:** The ball is dead where picked up by A2. The try is ended. [Cited by 8-3-2-d-2]
- V. On a one-point try attempt, Team A’s kick is blocked. The ball, untouched beyond the neutral zone, (a) is recovered by B3 on their one-yard line or (b) hits the ground in Team B’s end zone. **RULING:** (a) B3 may advance the ball. (b) The ball is dead, the try is ended (Rule 8-3-1). [Cited by 8-3-2-d-2]
- VI. On a one-point try attempt, Team A’s kick is blocked. B3 recovers the ball and advances across Team A’s goal line. During B3’s run, B4 clips. **RULING:** No score, the try is ended, and the penalty is enforced on the succeeding kickoff (Rules 10-2-7-a and 10-2-7-b). [Cited by 8-3-1, 8-3-2-d-2]
- VII. On a try attempt, B1 intercepts Team A’s legal forward pass in their end zone. They run the ball across Team A’s goal line, and (a) there are no fouls during the run, (b) B3 clips during the run or (c) A2 fouls during the run. **RULING:** (a) Award Team B two points. (b) No score, the try is ended, and the penalty is enforced on the succeeding kickoff (Rule 10-2-7-a). (c) Award Team B two points, and the penalty is enforced on the succeeding kickoff (Rules 8-3-1, 10-2-7-a and 10-2-7-b). [Cited by 10-2-7-b]

- VIII. On a try attempt, A1 muffs the hand-to-hand snap from the snapper. A2 recovers the ball and carries it into Team B's end zone. **RULING:** Award Team A two points (Rule 2-11-2). [Cited by 8-3-2-d-5]
- IX. On a one-point try attempt, Team A's kick is blocked and B75 recovers at the two-yard line. B75 then fumbles and the ball rolls into the end zone, where B61 recovers while grounded. **RULING:** Safety. Award Team A one point (Rule 8-1-1). [Cited by 8-1-1]

Fouls During a Try Before a Change of Team Possession

ARTICLE 3. a. *Offsetting fouls:* If both teams foul during the down and Team B fouls before the change of possession, the fouls offset and the down is repeated, even if additional fouls occur after the change of possession. Any repeat of the down after offsetting fouls must be from the previous spot. (A.R. 8-3-3:II, IV-V) (A.R. 10-2-5:XI).

b. *Fouls by Team B on a try:*

1. When the try is successful, Team A shall have the option of declining the score and repeating the try after enforcement, or declining the penalty(ies) and accepting the score. Team A may accept the score with penalties for personal fouls and unsportsmanlike conduct fouls enforced on the succeeding kickoff or from the succeeding spot in extra periods. (A.R. 3-2-3:VI) (A.R. 8-3-2:II) (A.R. 8-3-3:I) (A.R. 10-2-5:IX-X)
2. A repeat of the down after a penalty against Team B may be from any point on or between the hash marks on or behind the yard line where the penalty leaves the ball. (A.R. 8-3-3:III)

c. *Fouls by Team A on a try:*

1. After a foul by Team A on a successful try, the ball shall be put in play at the spot where the penalty leaves it. (A.R. 8-3-3:I)
2. If Team A commits a foul for which the penalty includes loss of down, the try is over, and the score is cancelled, and no yardage penalty is assessed on the succeeding kickoff.
3. If before a change of team possession Team A commits a foul that is not offset, and during the down there is neither another change of team possession nor a score, the penalty is declined by rule.

d. *Dead-ball enforcement:*

1. Penalties for fouls occurring after the ball is ready for play and before the snap are enforced before the next snap.
2. Penalties for live-ball fouls treated as dead-ball fouls occurring during the try down are enforced on the succeeding kickoff or from the succeeding spot in extra periods. If the try is repeated, these penalties are enforced on the repeat (Rule 10-1-6). (A.R. 3-2-3:VII)

e. *Roughing or running into kicker or holder:* Roughing or running into the kicker or holder is a live-ball foul.

f. *Kick catch interference:* The penalty for interference with a kick catch is declined by rule. Any score by Team A is cancelled.

Approved Ruling 8-3-3

- I. During a try attempt, Team A's legal kick, untouched and in the air, has crossed the neutral zone when a foul occurs. **RULING:** If the foul is by Team A and the try is unsuccessful, and Team B does not gain possession, the try ends. If the foul is by Team A and the try is successful, the penalty is at the previous spot. If the foul is by Team B and the try is successful, score the point unless Team A chooses to accept the penalty and attempt a two-point play. The try is exempt from postscrimmage kick enforcement. Penalties for Team B personal fouls on a successful try may be enforced on the subsequent kickoff or at the succeeding spot in extra periods. If the try is unsuccessful, Team A may accept the penalty and the down will be repeated. [Cited by 8-3-3-b-1, 8-3-3-c-1]
- II. Both teams foul during a try, and Team B had not gained possession. **RULING:** Repeat the down at the previous spot. [Cited by 8-3-3-a]
- III. Lined up for the try at the middle of the B-3, Team A commits a false start and is penalised to the B-8. The kick attempt is blocked, but B77 was in the neutral zone at the snap. The penalty takes the ball to the

B-4 for the repeat of the down. Team A requests that the ball be placed at the right hash mark. **RULING:** The officials grant the request and the ball is made ready for play at the B-4 on the right hash mark. [Cited by 8-3-3-b-2]

- IV. During a try, both teams foul before Team B intercepts a forward pass. On the return, (a) B23 clips or (b) A18 tackles the ball carrier by twisting their face mask. **RULING:** (a) and (b) The fouls offset and the down is repeated. [Cited by 8-3-3-a]
- V. During a try, B79 is in the neutral zone at the snap. B20 intercepts a forward pass and A55 tackles them by pulling the face mask. **RULING:** The fouls offset and the down is repeated. [Cited by 8-3-3-a]

Fouls During a Try After a Change of Team Possession

ARTICLE 4. Fouls after a change of team possession are treated specially (Rule 10-2-7). (**A.R. 8-3-4:I-IV**)

Approved Ruling 8-3-4

- I. B15 intercepts Team A's legal forward pass and is running at midfield when tackled by A19, who grasps and pulls B15's face mask. **RULING:** The penalty is enforced on the succeeding kickoff (Rule 10-2-7-a). [Cited by 8-3-4]
- II. B1 intercepts Team A's legal forward pass and runs it to midfield. During the run of the interception, B2 clips in Team B's end zone. **RULING:** The penalty is enforced on the succeeding kickoff (Rule 10-2-7-a). [Cited by 8-3-4]
- III. During a two-point try attempt, Team A is flagged for an illegal shift. B21 recovers a fumble and on the return, B45 clips and A80 punches an opponent. B21 carries the ball across the goal line. **RULING:** The score does not count, the fouls cancel, the down is not repeated and the try is ended. A80 is disqualified. [Cited by 10-2-7-c, 8-3-4]
- IV. During a two-point try attempt, Team A is flagged for an illegal shift. B21 recovers a fumble and on the return, A80 punches an opponent. B21 carries the ball across the goal line. **RULING:** The score counts and the penalty for A80's flagrant foul is enforced on the succeeding kickoff or at the succeeding spot in extra periods. A80 is disqualified. [Cited by 10-2-7-c, 8-3-4]

Fouls After a Try

ARTICLE 5. Penalties for fouls occurring after a try are enforced on the succeeding kickoff or from the succeeding spot in extra periods. However, if the try is repeated, these penalties are enforced before the repeat (Rule 10-1-6). (**A.R. 10-2-5:XIII-XV**) (**A.R. 3-2-3:VII**)

Next Play

ARTICLE 6. After a try, the ball shall be put in play by a kickoff or at the succeeding spot in extra periods. The team scoring the six-point touchdown shall kick off.

SECTION 4. Field Goal

How Scored

- ARTICLE 1. a. A field goal shall be scored if a scrimmage kick, which may be a drop kick or place kick, passes over the crossbar between the uprights of the receiving team's goal before it touches a player of the kicking team or the ground.
- b. If a legal field goal attempt passes over the crossbar between the uprights and is dead beyond the end line or is blown back but does not return over the crossbar and is dead anywhere, it shall score a field goal. The crossbar and uprights are treated as a line, not a plane, in determining forward progress of the ball.

Next Play

ARTICLE 2. a. *Successful field goal.* After a field goal is scored, the ball shall be put in play by a kickoff or at the succeeding spot in extra periods. The team scoring the field goal shall kick off.

b. *Unsuccessful field goal attempt.*

1. When the ball is declared dead and is untouched by Team B after crossing the neutral zone, it belongs to Team B. Except in an extra period, Team B will snap the ball at either the previous spot, the 20-yard line or the dead-ball spot (whichever is most advantageous to Team B).
 - (a) The 20-yard-line snap shall be from midway between the hash marks unless Team B selects a different location on or between the hash marks before the ready-for-play signal.
 - (b) After the ready-for-play signal, the ball may be relocated after a charged team timeout, unless preceded by a Team A foul or offsetting fouls.
2. If the ball does not cross the neutral zone, or if Team B touches the ball after it crosses the neutral zone, all rules pertaining to scrimmage kicks apply. **(A.R. 6-3-4:II) (A.R. 8-4-2:I-VIII) (A.R. 10-2-3:V)**

Approved Ruling 8-4-2

- I. Fourth and eight on Team B's 40-yard line. Team A's untouched field goal attempt rolls dead on Team B's seven-yard line. **RULING:** Team B's ball at Team B's 40-yard line. [Cited by 8-4-2-b-2]
- II. Fourth and eight on Team B's 40-yard line. Team A's attempted field goal touches B1 at the 10-yard line and goes out of bounds at the five-yard line. **RULING:** Team B's ball at Team B's five-yard line. [Cited by 8-4-2-b-2]
- III. Fourth and eight on Team B's 40-yard line. Team A's attempted field goal strikes the ground at the three-yard line and bounces into the end zone, where it is received in the air and then downed by a Team B player. **RULING:** Touchback (Rule 8-6-1-b). Team B's ball at the 20-yard line. [Cited by 8-4-2-b-2]
- IV. Fourth and eight on Team B's 18-yard line. Team A's unsuccessful field goal attempt goes out of the end zone. **RULING:** Team B's ball at the 20-yard line. [Cited by 8-4-2-b-2]
- V. Team A's unsuccessful field goal attempt strikes the ground beyond the neutral zone and bounces back across the neutral zone, where it is recovered by B1 and advanced into the end zone. **RULING:** Touchdown (Rule 6-3-5). [Cited by 6-3-5, 8-4-2-b-2]
- VI. Fourth and six on Team B's 18-yard line. Team A's unsuccessful field goal attempt strikes the ground beyond the neutral zone and bounces back across the neutral zone to Team B's 28-yard line, where it goes out of bounds or is recovered and downed by either team. The kick is untouched beyond the neutral zone. **RULING:** Team B's ball, first and 10 at Team B's 28-yard line (Rules 6-3-6, 6-3-7 and 8-4-2-b). [Cited by 8-4-2-b-2]
- VII. Team A snaps the ball at the B-15 to attempt a field goal. The kick is blocked, crosses the neutral zone and lands at the B-12. Before any player touches it beyond the neutral zone, the ball rebounds behind the neutral zone and goes out of bounds at the (a) B-17; (b) B-25. **RULING:** (a) Team B's ball, first and 10 at the B-20; (b) Team B's ball, first and 10 at the B-25. (Rules 6-3-7 and 8-4-2-b) [Cited by 6-3-7, 8-4-2-b-2]
- VIII. Fourth and goal at the B-10. The field goal attempt is blocked and hits the ground at the B-7. It then rebounds to the B-13 where B44 muffs it. A44 recovers at the B-11. **RULING:** First and 10 for Team A at the B-11. Team B has touched a scrimmage kick that has crossed the neutral zone. (Rule 6-3-3) [Cited by 6-3-3, 8-4-2-b-2]

SECTION 5. Safety

How Scored

ARTICLE 1. It is a safety when:

- a. The ball becomes dead out of bounds behind a goal line, except from an incomplete forward pass, or becomes dead in the possession of a player on, above or behind their own goal line, or becomes dead by rule, and the defending team is responsible for the ball being there. **(A.R. 6-3-1:IV) (A.R. 7-2-4:I) (A.R. 8-5-1:I-II, IV and VI-XII) (A.R. 8-7-2:II) (A.R. 9-4-1:VIII)**

When in question, it is a touchback, not a safety.

Exception: It is not a safety if a player between their own team's five-yard line and goal line:

- (a) intercepts a pass or fumble; or recovers an opponent's fumble or backward pass; or catches or recovers an opponent's kick; and
- (b) their original momentum carries them into their own end zone; and

- (c) the ball remains behind that team's goal line and is declared dead in that team's possession there. This includes a fumble that goes from the end zone into the field of play and out of bounds (Rule 7-2-4-a-1) or is at rest and no player attempts to secure it (Rule 7-2-5).

If conditions (a)-(c) are satisfied above, the ball belongs to this player's team at the spot where they gained possession.

- b. An accepted penalty for a foul leaves the ball on or behind the offending team's goal line. (*Exception:* Rules 10-2-7-c and 10-2-7-a). (**A.R. 8-5-1:III, V**) (**A.R. 10-2-2:VI**)

Approved Ruling 8-5-1

- I. A10, after receiving the snap in their own end zone, is downed with the ball resting on their goal line, its forward point being in the field of play. **RULING:** Safety. A part of the dead ball is on the ball carrier's goal line. [Cited by 2-9-2, 4-2-4-a, 5-1-3-a-1, 8-5-1-a]
- II. A scrimmage kick fails to cross the neutral zone, or crosses the neutral zone and is first touched by Team B, or is untouched and then rebounds into the end zone where it is declared dead in Team A's possession. **RULING:** Safety (Rule 8-7-2-a). [Cited by 8-5-1-a, 8-7-2-a]
- III. B1 intercepts a legal forward pass (not a try) deep in their end zone, and advances but does not get out of the end zone, where they are downed. During the run, B2 clips A1 in the end zone. **RULING:** Safety, since the penalty leaves the ball in Team B's possession in the end zone. [Cited by 8-5-1-b]
- IV. B1 intercepts a pass or fumble or catches a scrimmage or free kick between their five-yard line and the goal line, and their momentum carries them into the end zone. The ball remains in the end zone and is declared dead there in Team B's possession. **RULING:** Team B's ball at the spot where the pass or fumble was intercepted, or the kick was caught. The ruling is the same if B1 had recovered a fumble, a backward pass or a kick under similar circumstances. [Cited by 8-5-1-a]
- V. B1 intercepts a pass or fumble or catches a scrimmage or free kick between their five-yard line and the goal line, and their momentum carries them into the end zone. Before the ball is declared dead, B2 clips in the end zone. B1 does not get out of the end zone, and the ball is declared dead. **RULING:** Safety by penalty. The basic spot is the end of the run where B1 gained possession between the five-yard line and goal line, and the foul is behind the basic spot. [Cited by 8-5-1-b]
- VI. Team A's fumble or backward pass strikes the ground. Team B muffs the ball in an attempt to recover, but it crosses Team A's goal line, where Team A falls on the ball or the ball goes out of bounds from the end zone. **RULING:** Safety. The impetus came from the fumble or pass (Rule 8-7-2-a). [Cited by 8-5-1-a, 8-7-2-a]
- VII. A36 intends to punt from behind their goal line, but they muff the ball. After A36 recovers the ball, they run into the pylon at the intersection of the sideline and goal line. **RULING:** Safety, unless the entire ball is beyond the goal line as the ball carrier contacts the sideline or pylon. The ball is dead at its most forward point when A36 contacts the pylon or sideline (Rules 2-31-3 and 4-2-4-d). [Cited by 2-31-3-c, 4-2-4-d, 8-5-1-a]
- VIII. B40 intercepts a pass on Team B's four-yard line. Their momentum is taking them into the end zone when they fumble the ball on the one-yard line and (a) B40, the fumbler, recovers the fumble in the end zone, or (b) B45, a teammate of the fumbler, recovers the fumble in the end zone. **RULING:** Safety in both (a) and (b). [Cited by 8-5-1-a, 8-7-2-a]
- IX. B47 intercepts a pass at the B-3. Their momentum carries them into the end zone where they fumble. The ball rolls into the field of play. A33 recovers at the B-2 but they are hit and fumble. The ball rolls into the end zone and over the end line. **RULING:** Touchback. Team B's ball, first and 10 at the B-20. The momentum rule applies only if the ball remains in the end zone and is declared dead there. (Rule 8-6-1) [Cited by 8-5-1-a]
- X. Third and five at the B-20. Defensive back B44 intercepts a forward pass in their end zone. While still in the end zone they fumble the ball. It rolls forward, goes into the field of play, and in the scramble the ball goes back into the end zone (a) where B44 recovers while grounded; (b) and over the end line. **RULING:** (a) and (b) Safety, two points for Team A. The impetus for the ball going into the end zone the second time is B44's fumble. The scramble to recover the ball does not add new impetus. The momentum rule does not apply because the ball did not remain in the end zone. (Rule 8-7-2) [Cited by 8-5-1-a]
- XI. 4/Goal @ B-8. Runner A44 is hit at the B-5 and fumbles, and B54 bats the grounded loose ball at the B-3 back into their own end zone. A88 sees the loose ball and recovers while the ball is still in the end zone. **RULING:** Safety, score 2 points for Team A. The bat is a legal bat since B54 is batting the ball backward (Rule 9-4-1-c), but B54 does add a new impetus to the ball and is responsible for the ball's progress into Team B's end zone (Rule 8-7-2-b-1). When A88 recovers the ball, the ball is declared dead based on the

4th down fumble rule (Rule 7-2-2-a Exception 2). The ruling is a safety because the ball becomes dead by rule in the end zone, and B54 is responsible for the ball being there (Rule 8-5-1-a). The safety rule and the fourth down fumble rule would seem to be in conflict here, but the spirit and intent of the safety rule is extremely specific to this play and would supersede the fourth down fumble rule which describes generally how recoveries by Team A on fourth down are handled. [Cited by 8-5-1-a]

- XII. After a safety, Team A free kick the ball by punting it from their own 20 yard line into a very strong wind. The wind blows the punt back over the kicker's head and it bounces at Team A's 15 yard line. The kick rolls into Team A's end zone where it comes to rest. In the confusion, no player attempts to recover the ball and it is declared dead. **RULING:** Safety. Rule 8-5-1-a prevails over any attempt to apply Rule 8-2-1-c. [Cited by 8-5-1-a]

Kick After Safety

ARTICLE 2. After a safety is scored, the ball belongs to the defending team at its own 20-yard line, and that team shall put the ball in play on or between the hash marks by a free kick that may be a punt, drop kick or place kick (*Exception:* Extra-period and try rules).

SECTION 6. Touchback

When Declared

ARTICLE 1. It is a touchback when:

- a. The ball becomes dead out of bounds behind a goal line, except from an incomplete forward pass, or becomes dead in the possession of a player on, above, or behind their own goal line and the attacking team is responsible for the ball being there (Rule 7-2-4-b) (**A.R. 7-2-4:I**) (**A.R. 8-6-1:I-III**)
- b. A kick becomes dead by rule behind the defending team's goal line and the attacking team is responsible for the ball being there (*Exception:* Rule 8-4-2-b). (**A.R. 6-3-4:III**)

Approved Ruling 8-6-1

- I. Team A's fumble strikes the pylon at the intersection of Team B's goal line and sideline. **RULING:** Touchback. Team B's ball at the 20-yard line (Rules 7-2-4-b and 4-2-3-b). [Cited by 2-31-3-c, 7-2-4-b, 8-6-1-a]
- II. B1 intercepts Team A's legal forward pass in their own end zone, after which A1 snatches the ball from their hand while in Team B's end zone. **RULING:** Touchdown. The ball is not automatically dead when intercepted, but it becomes dead when A1 gets possession. However, if in the judgement of the official there is perceptible time during which the Team B player made no attempt to advance after the interception, declaring a touchback is justified. [Cited by 8-6-1-a]
- III. Third and five at the B-20. Defensive back B44 intercepts a forward pass in their end zone. While still in the end zone they fumble the ball. It rolls forward, goes into the field of play, and in the scramble A33 kicks the ball into the end zone and over the end line. **RULING:** First and 10 for Team B at the B-30. The result of the play is a touchback, and therefore the basic spot for enforcement of the 10-yard penalty for illegally kicking the ball is the B-20. The touchback results because of the new impetus given by A33 kicking the ball. (Rules 2-16-1-a, 8-7-1, 10-2-2-d-2-a) [Cited by 8-6-1-a]

Snap After a Touchback

ARTICLE 2. After a touchback is declared, the ball belongs to the defending team at its own 20-yard line, unless the touchback results from a free kick, in which case the ball belongs to Team B at its 25-yard line. The ball shall be put in play on or between the hash marks by a snap (*Exception:* Extra-period rules). The snap shall be from midway between the hash marks, unless a different position on or between the hash marks is selected by the team designated to put the ball in play before the play clock is at 25 seconds or before any subsequent ready-for-play signal. After the ready-for-play signal, the ball may be relocated after a charged team timeout, unless preceded by a Team A foul or offsetting fouls.

SECTION 7. Responsibility and Impetus

Responsibility

ARTICLE 1. The team responsible for the ball being out of bounds behind a goal line or being dead in the possession of a player on, above or behind a goal line is the team whose player carries the ball or imparts an impetus to it that forces it on, above or across the goal line, or is responsible for a loose ball being on, above or behind the goal line.

Initial Impetus

- ARTICLE 2. a. The impetus imparted by a player who kicks, passes, snaps or fumbles the ball shall be considered responsible for the ball's progress in any direction even though its course is deflected or reversed after striking the ground or after touching an official or a player of either team (A.R. 6-3-4:III) (A.R. 8-5-1:II, VI and VIII) (A.R. 8-7-2:I-IV).
- b. Initial impetus is considered expended and the responsibility for the ball's progress is charged to a player:
1. If they kick a ball not in player possession or bat a loose ball after it strikes the ground.
 2. If the ball comes to rest and they give it new impetus by any contact with it, other than through forced touching (Rule 2-11-4-c).
- c. A loose ball retains its original status when there is new impetus.

Approved Ruling 8-7-2

- I. Ball carrier A1, advancing toward Team B's goal line, fumbles when B1 bats the ball from their hand or tackles them from the rear. In either case, A1 loses possession short of the goal line, and the ball goes into Team B's end zone where Team B recovers. **RULING:** Touchback. Impetus is charged to the fumble by Team A (Rule 8-6-1-a). [Cited by 7-2-4-b, 8-7-2-a]
- II. Any kick by Team A strikes the ground and a Team B player bats the ball across Team B's goal line, where Team B recovers it while grounded or it goes out of bounds. **RULING:** New impetus is given by Team B. Safety, two points for Team A. Batting the kick is considered to have destroyed the impetus of the kick and imparted a new impetus. However, merely touching or deflecting the kick, or being struck by it, does not destroy the impetus of the kick (Rule 8-5-1-a). [Cited by 8-5-1-a, 8-7-2-a]
- III. Team A punts. The ball is touched by Team B (no impetus added) and crosses Team B's goal line. Then Team B falls on the ball or the ball goes out of bounds from the end zone. **RULING:** Touchback. The same ruling applies if a kick in flight strikes Team B or is merely deflected by an attempted catch. Team B may recover and advance, and it is a touchback if a Team B player is downed in the end zone or goes out of bounds behind the goal line (Rule 8-6-1-a). [Cited by 8-7-2-a]
- IV. Team A free kicks from its 35-yard line. The ball is rolling on the ground on Team B's three-yard line when B10 kicks the ball into the end zone and over the end line. **RULING:** Safety, due to the new impetus by B10. Team B foul for illegally kicking the ball. If the penalty (10 yards) is accepted, the down is repeated with the free kick at the A-45. (Rules 9-4-4 and 10-2-2-d-4.) [Cited by 8-7-2-a, 9-4-4]

RULE 9

Conduct of Players and Others Subject to the Rules

SECTION 1. Personal Fouls

All fouls in this section (unless noted) and any other acts of unnecessary roughness are personal fouls. For flagrant personal fouls mandating disciplinary authority review, see Rule 9-6. Except as otherwise noted, the penalties for all personal fouls are as follows:

PENALTY – Personal foul. 15 yards. For dead-ball fouls, 15 yards from the succeeding spot.

Automatic first down for fouls by Team B if not in conflict with other rules. Penalties for Team A live-ball personal fouls behind the neutral zone are enforced from the previous spot. Safety if the live-ball foul occurs behind Team A's goal line. [S7, S24, S25, S26, S28, S34, S38, S39, S40, S41, S45 or S46: PF-*]. Flagrant offenders shall be disqualified [S47: DSQ].

For Team A fouls during free or scrimmage kick plays: Enforcement may be either at the previous spot or, if the scrimmage kick crosses the neutral zone, the spot where the subsequent dead ball belongs to Team B (field goal plays exempted) (Rules 6-1-8 and 6-3-13).

For Team B personal fouls during a legal forward pass play (Rules 7-3-12 and 10-2-2-e): Enforcement is at the end of the last run when it ends beyond the neutral zone and there is no change of team possession during the down. If the pass is incomplete or intercepted, or if there is a change of team possession during the down, the penalty is enforced at the previous spot.

Flagrant Personal Fouls

ARTICLE 1. Before the game, during the game and between periods, all flagrant personal fouls (Rule 2-10-3) require disqualification. Team B flagrant personal fouls require first downs if not in conflict with other rules.

Striking Fouls and Tripping

- ARTICLE 2. a. No person subject to the rules shall strike an opponent with the knee; strike an opponent's helmet (including the face mask), neck, face or any other part of the body with an extended forearm, elbow, locked hands, palm, fist, or the heel, back or side of the open hand; or gouge an opponent (A.R. 9-1-2:II, IV).
- b. No person subject to the rules shall strike an opponent with their foot or any part of their leg that is below the knee.
- c. There shall be no tripping. Tripping is intentionally using the lower leg or foot to obstruct an opponent below the knee (Rule 2-28). (A.R. 9-1-2:I)

Approved Ruling 9-1-2

- I. A player on defense sticks out their foot and trips an opponent. (a) The opponent is a wide receiver running a passing route. (b) The opponent is the ball carrier. **RULING:** (a) and (b) Personal foul, tripping. Penalty — 15 yards, automatic first down. [Cited by 9-1-2-c]
- II. A1, a ball carrier, strikes tackler B6 with their extended forearm just before being tackled. **RULING:** Personal foul. Penalty — 15 yards. Enforce from the previous spot if foul occurs behind the neutral zone. Disqualification if flagrant. Safety if the foul occurs behind Team A's goal line. [Cited by 9-1-2-a]
- III. A11 completes a forward pass to A88 who is tackled in the field of play beyond the neutral zone. During the play defensive end B88 is flagged for a personal foul against A79. **RULING:** The 15-yard penalty is enforced at the spot where A88 is tackled (Rules 7-3-12 and 9-1 Penalty). [Cited by 10-2-2-e, 7-3-12]

- IV. 1/10 @ A-25. Defender B21 is in press coverage, and at the snap strikes wideout A88 in the face mask. A88 is initially disrupted from running the route. A12 is sacked for a 7-yard loss. **RULING:** Personal foul by B21 for striking A88. Team A will have 1/10 @ A-40. With this type of action, continuous contact to the opponent's face, helmet (including the face mask) or neck is not a requirement to be a foul as per Rule 9-1-8-a. [Cited by 9-1-2-a]

Targeting and Making Forcible Contact With the Crown of the Helmet

ARTICLE 3. No player shall target and make forcible contact against an opponent with the crown of their helmet. The crown of the helmet is the top segment of the helmet; namely, the circular area defined by a 6-inch radius from the apex (top) of the helmet. This foul requires that there be at least one indicator of targeting (see Rule 2-35). (A.R. 9-1-3:I)

PENALTY – Flagrant foul. In addition to the 15-yard penalty, automatic disqualification. The 15-yard penalty is not enforced if the video judge overturns the disqualification [S38, S24 and S47: PF-TGC/DSQ]

Approved Ruling 9-1-3

- I. Forward passer A12 inside the tackle box is looking for an open receiver. Before or just as they release the ball, A12 is hit from the side at the ribs, thigh or knee by B79, who dives forward and leads with the crown (top) of their helmet. **RULING:** Foul by B79 for targeting their opponent and making forcible contact with the top of their helmet. 15 yards, first down. B79 is automatically disqualified. [Cited by 9-1-3]

Targeting and Making Forcible Contact to Head or Neck Area of a Defenseless Player

ARTICLE 4. No player shall target and make forcible contact to the head or neck area of a defenseless opponent (Rule 2-27-14) with the helmet, forearm, hand, fist, elbow or shoulder. This foul requires that there be at least one indicator of targeting (see Rule 2-35). (A.R. 9-1-4:I-VI)

PENALTY – Flagrant foul. In addition to the 15-yard penalty, automatic disqualification. The 15-yard penalty is not enforced if the video judge overturns the disqualification. [S38, S24 and S47: PF-TGD/DSQ]

Approved Ruling 9-1-4

- I. Receiver A83 has just leaped and received a forward pass. As A83 is about to regain their balance, B45 launches and drives into A83 above the shoulder area with their helmet or shoulder. **RULING:** Foul by B45 for targeting and making forcible contact with a defenseless opponent above the shoulders. 15 yards, first down. B45 is automatically disqualified. [Cited by 9-1-4]
- II. As ball carrier A20 sweeps around the end and heads upfield, they lower their head and (a) unintentionally contact; or (b) intentionally attack defensive end B89 who is trying to tackle them. B89's head is up and the players meet helmet to helmet. **RULING:** (a) No foul. Neither A20 nor B89 is a defenseless player and neither has targeted their opponent in the sense of Rule 9-1-3. (b) Foul by A20 for targeting. By choosing to attack with their head, A20 has become subject to Rule 9-1-3. [Cited by 9-1-4]
- III. A44 is covering the kickoff that opens the second half. During the return, as A44 is running at the Team B 45-yard line, B66 targets and launches into A44 from the side, a blind-side block. B66 first makes contact with their forearm at A44's (a) neck; (b) upper arm or shoulder. **RULING:** (a) Foul by B66 for an illegal blind-side block and targeting a defenseless player by making forcible contact at the head or neck area. 15-yard penalty at the end of the run. B66 is disqualified. (b) Foul for an illegal blind-side block. This is not a foul for targeting because the contact by B66 is not to the head or neck area. (Rule 2-27-14). [Cited by 9-1-4]
- IV. A12 who normally plays quarterback is lined up as a wide receiver in the backfield and A33 is five yards behind the snapper in a shotgun formation. A33's pass intended for A12 is intercepted. During the interception return B55 targets and launches at A33, striking them in the side of the helmet. **RULING:** Foul by B55 for targeting and making forcible contact at the head of a defenseless player. For the purposes of Rule 2-27-14, A33 is a defenseless player since they played the down in the role of the quarterback. [Cited by 9-1-4]
- V. End A81 is split far to the left of the formation, to the outside of defensive end B89. On a sweep play in their direction B89 moves to their left to focus on the ball carrier, losing sight of A81. A81 then cuts to the inside, takes aim and launches at B89, forcibly contacting them with their forearm to B89's neck. **RULING:** Foul for blind-side block with targeting. Under Rule 9-1-4, 15 yard penalty, A81 is disqualified. B89 is a defenseless player as they are subject to the blind-side block (Rule 2-27-14). [Cited by 9-1-4]

- VI. Ball carrier A33 has gained several yards and is in the grasp of two defenders. A33's forward progress has been stopped and is being driven back, but the ball has not been declared dead. Linebacker B55 crouches and thrusts themselves forward, driving their forearm into the side of A33's helmet. **RULING:** Targeting foul by B55. 15 yard penalty, B55 is disqualified. A33 is a defenseless player since they are in the grasp of the opponents and their forward progress has been stopped (Rule 2-27-14). [Cited by 9-1-4]
- VII. Pass receiver A88 has just caught the ball when defender B55 launches and drives their shoulder and forearm into their upper body. The back judge flags B55 for targeting to the head-neck area and they are disqualified. The referee makes their announcement of the targeting foul, and the play goes to review. **RULING:** After review, the video judge rules that there was not forcible contact to the head-neck area, overturning the disqualification of B55. The referee announces that B55 is not disqualified and that there will be no 15-yard penalty.
- VIII. Punt receiver B44 is in position to catch a punt. A88 races down the field and launches at B44, driving the side of their helmet and shoulder into B44's upper body the instant before the ball arrives. The side judge and field judge throw their flags and report to the referee that A88 is charged with kick-catch interference with targeting to the head-neck area. The referee makes their announcement of kick-catch interference with targeting to the head-neck area. The play goes to review. **RULING:** After review, the video judge rules that A88 did not make forcible contact to the head-neck area, overturning their disqualification. The referee announces that A88 is not disqualified and that the 15-yard penalty for interference with the opportunity to catch a kick will be enforced.
- IX. On a punt return, B44 launches at A66 from the blind side and drives their shoulder into them. The force of the contact is at A66's side below the shoulder. **RULING:** Foul for blind-side block. A66 is a defenseless player because B44 executes a blind-side block. However, this is not a targeting foul because the forcible contact is not to the head/neck area.

Clipping

ARTICLE 5. There shall be no clipping (Rule 2-5).

Exceptions:

1. Offensive players who are on the line of scrimmage at the snap within the free-blocking zone (Rule 2-3-6) legally may clip in the free-blocking zone, subject to the following restrictions:
 - (a) A player in the free-blocking zone may not block an opponent with the force of the initial contact from behind and at or below the knee.
 - (b) A player on the line of scrimmage within the free-blocking zone may not leave the zone and return and legally clip.
 - (c) No player may violate Rule 9-1-6 (Blocking Below the Waist).

NOTE: The free-blocking zone disintegrates when the ball leaves the zone (Rule 2-3-6).
2. When a player turns their back to a potential blocker who has committed themselves in intent and direction of movement.
3. When a player attempts to reach a ball carrier or simulated ball carrier or attempts to legally recover or catch a fumble, a backward pass, a kick or a touched forward pass, they may push an opponent below the waist at or to the buttocks (Rule 9-3-5 Exception 3).
4. When an eligible player behind the neutral zone pushes an opponent below the waist at or to the buttocks to get to a forward pass (Rule 9-3-5 Exception 5).
5. Clipping is allowed against the ball carrier or simulated ball carrier.

Blocking Below the Waist

ARTICLE 6.

a. *Team A prior to a change of team possession:*

1. Linemen with initial position completely inside the tackle box may legally block below the waist inside the tackle box on their initial line charge. A block initiated up to 1 yard beyond the neutral zone is considered within the tackle box. After the initial line charge, these linemen may block below the waist within the tackle box until the ball leaves the tackle box only if the force of the initial contact is directed from the front (**A.R. 9-1-6:VIII-IX, XI-XII**).

2. Stationary backs lined up with any part of their body inside the tackle box may block below the waist within the tackle box until the ball leaves the tackle box only if the force of the initial contact is directed from the front. A block initiated up to 1 yard beyond the neutral zone is considered within the tackle box (**A.R. 9-1-6:I-III, V-VI, X, XIII**).

"Directed from the front" is defined as within the clock face region between "10 o'clock and 2 o'clock" forward of the area of concentration of the player being blocked. Once a player leaves the tackle box during a play, they are considered outside the tackle box for the remainder of the down.

3. All other Team A players are not allowed to block below the waist.

b. *Team B prior to a change of team possession:*

1. Players aligned in a stationary position within 1 yard of the line of scrimmage within the tackle box may legally block below the waist in the tackle box on their initial line charge (**A.R. 9-1-6:IV**).
2. All other Team B players are not allowed to block below the waist except against a ball carrier or simulated ball carrier (**A.R. 9-1-6:VII**).

c. *Kicks:*

During a down in which there is a free kick or scrimmage kick, blocking below the waist by any player is illegal except against a ball carrier or simulated ball carrier.

d. *After change of team possession:*

After any change of team possession, blocking below the waist by any player is illegal except against a ball carrier or simulated ball carrier.

e. *Clipping.* No player may violate Rule 9-1-5 (Clipping).

Approved Ruling 9-1-6

- I. 1/10 @ A-40. Back A44 is lined up just behind the RT, and has their left foot inside the RT's outside foot. At the snap, A44 works back across the formation and blocks B77 below the waist from the side. B77 is inside the tackle box and 1 yard in the offensive backfield at the time of the block. During the play, A33 runs for a 12-yard gain. **RULING:** The block by A44 is an illegal block below the waist because it is not directed from the front. Stationary backs lined up within the tackle box may block below the waist in the tackle box until the ball leaves the tackle box only if the force of the initial contact is directed from the front. The penalty is 15 yards and is enforced from the previous spot. Team A will have 1/25 @ A-25. [Cited by 9-1-6-a-2]
- II. 1/10 @ A-40. Back A44 is stationary and lined up 4 yards deep and is just behind the RG. After the snap, QB A12 takes a deep drop, and remains in the tackle box looking downfield. Linebacker, B55 blitzes between the LG and LT, and A44 crosses over to the left side of the formation and blocks B55 below the waist at the A-36. The block is directed from the front. After the block, A12's pass is completed to A88 for a gain of 15-yards. **RULING:** There is no foul on the play. The block by back A44 is legal as a stationary back lined up within the tackle box may block below the waist in the tackle box until the ball leaves the tackle box only if the force of the initial contact is directed from the front. Team A will have 1/10 @ B-45. [Cited by 9-1-6-a-2]
- III. Back A41 is stationary at the snap, directly behind the right tackle in a balanced line formation. Their left shoulder is inside the tackle box. The quarterback hands the ball to back A22 who runs straight ahead. A41 blocks B2 who moves into the offensive backfield to make a play on the ball carrier before A22 reaches the line of scrimmage. The block is below the waist and clearly at the side. **RULING:** Illegal block. A41 is partially inside the tackle box and behind the second lineman at the snap, but the block is not from the front. [Cited by 9-1-6-a-2]
- IV. Defensive end B88 is lined up on the outside shoulder of tackle A75. On the initial line charge, B88 blocks tackle A75 below the waist from the side inside the tackle box. **RULING:** No foul for an illegal block below the waist. [Cited by 9-1-6-b-1]
- V. Back A22 is stationary inside the tackle box at the snap. After the snap, A22 shoots between the tackle and the guard and blocks B55 below the waist directed from the front. The initial contact is three yards beyond the neutral zone. **RULING:** Illegal block below the waist. The block is directed from the front, but is beyond the neutral zone. [Cited by 9-1-6-a-2]

- VI. Third and seven at the A-30. The ball is at the left hash mark. Back A22 is split completely outside the frame of the tackle on the left side, and B40 moves out to cover them. The handoff goes to back A44 who sweeps around the right end. As the play develops B40 follows the play and A22 chases them. At the A-34 beyond the right hash mark, A22 overtakes B40 and blocks them below the waist clearly and directly at the front (10-to-2). A44 is tackled at the B-45. **RULING:** Illegal block below the waist. A22's initial position is outside the tackle box, so A22 may not legally block below the waist. [Cited by 9-1-6-a-2]
- VII. First and 10 at the A-40. A12 takes the snap and starts on a sweep to their right. Guard A66 pulls and leads the play. As the play develops, linebacker B55 blocks A66 from the front at the thigh at the A-39. A12 is driven out of bounds at the A-48. **RULING:** Illegal block below the waist. B55 was not aligned in a stationary position within one yard of the line of scrimmage and therefore cannot block below the waist. [Cited by 9-1-6-b-2]
- VIII. At the snap tight end A85 is aligned six yards from the snapper. Before the ball has left the tackle box, A85 blocks tackle B77 below the waist at the side. **RULING:** Illegal block below the waist. A85's initial position is outside the tackle box at the snap, so A85 may not block below the waist. 15-yard penalty. [Cited by 9-1-6-a-1]
- IX. First and 10 at the A-45. Guard A66 is next to the snapper. Immediately after the snap, A66 blocks (a) nose guard B55 at the A-46, or (b) linebacker B33 at the A-48. In either case the block is below the waist at the side of the opponent. **RULING:** (a) Legal block. A66 has left the tackle box, but a block initiated one yard beyond the neutral zone is considered within the tackle box. (b) Foul, illegal block below the waist. In this case, A66 has left the tackle box and has gone to the second level to make this low block. To be legal this block may not be below the waist. [Cited by 9-1-6-a-1]
- X. 3/10 @ A-25. Back A21 is stationary and is lined up in the tackle box. Just after the snap A21 immediately releases outside the tackle box. QB A12 is in the pocket to pass and A21 sees linebacker B54 blitzing. A21 returns into the tackle box and before A12 throws the pass, blocks B54 below the waist in the tackle box and the block is directed from the front. **RULING:** Foul by A21 for an illegal block below the waist. Once a player leaves the tackle box during the play, that player is considered outside the tackle box for the remainder of the down. A21 may not block below the waist once considered outside the tackle box. [Cited by 9-1-6-a-2]
- XI. 3/10 @ A-25. Left tackle A77 is lined up inside the tackle box and defender B55 is an edge rusher and is lined up near the line of scrimmage and just outside of A77. At the snap, A77 steps back into pass protection and B55 comes straight up the field rushing the passer. During the initial line charge of B55, A77 blocks B55 below the waist and the block is directed from the side well behind the neutral zone. A77 has one foot in the tackle box as the block is initiated. **RULING:** Legal block by A77. This action is considered part of the initial line charge and A77 can block below the waist and is not restricted to only blocking below the waist from the front. After the initial line charge, and if it is clearly a second act, then A77 is restricted to blocking below the waist in the tackle box and the block then must be directed from the front. [Cited by 9-1-6-a-1]
- XII. 3/10 @ A-25. Left tackle A77 is lined up inside the tackle box and defender B60 is lined up near the line of scrimmage and inside of A77 and is head up on the left guard. The play is a toss sweep to the right and as B60 (on their initial line charge) starts their pursuit, A77 releases to the right and blocks B60 below the waist from the side. **RULING:** Legal block by A77. This action is considered part of the initial line charge and A77 can block below the waist and is not restricted to only blocking below the waist from the front. There is no step count for initial line charge, just a judgement if the action becomes a second act. After the initial line charge, and if it is clearly a second act, then A77's block below the waist in the tackle box must be directed from the front. [Cited by 9-1-6-a-1]
- XIII. 3/10 @ A-25. Back A21 is stationary and is lined up in the tackle box. Just after the snap, A21 immediately steps up and blocks a blitzing linebacker 1 yard beyond the neutral zone. The block is below the waist and directed from the front. **RULING:** Legal block by A21. A block initiated 1 yard beyond the neutral zone is considered within the tackle box for both a lineman and back assuming that block meets all the other requirements for a legal block below the waist. [Cited by 9-1-6-a-2]

Late Hit, Action Out of Bounds

- ARTICLE 7. a. There shall be no piling on, falling on, or throwing the body on an opponent after the ball becomes dead. **(A.R. 9-1-7:I)**
- b. No opponent shall tackle or block the ball carrier or simulated ball carrier when they are clearly out of bounds or throw them to the ground after the ball becomes dead.

- c. It is illegal for any player to be clearly out of bounds when they initiate a block against an opponent who is out of bounds. The spot of the foul is the point on the sideline nearest to where the contact occurs (**A.R. 9-1-7:II**).

Approved Ruling 9-1-7

- I. After the ball is dead, a player throws themselves onto an opponent lying on the ground. **RULING:** Personal foul. Penalty — 15 yards from the succeeding spot and first down if by a Team B player and not in conflict with other rules. "Piling on" applies to a ball carrier or to any other opponent who is prostrate when the ball becomes dead. [Cited by 9-1-7-a]
- II. On a sweep play toward the sideline, linebacker B55 goes out of bounds to avoid a block. Guard A66 is leading the play, and just as they step on the sideline with their front foot they drive their shoulder in the waist at the front of B55 who is still out of bounds. **RULING:** Legal block. A66 does not have both feet out of bounds. [Cited by 9-1-7-c]

Helmet and Face Mask Fouls

- ARTICLE 8. a. No player shall continuously contact an opponent's face, helmet (including the face mask) or neck with hand(s) or arm(s) (**Exception:** By or against the ball carrier or simulated ball carrier). [S26: PF-HTF]
- b. No player shall grasp and then twist, turn or pull the face mask, chin strap or any helmet opening of an opponent. It is not a foul if the face mask, chin strap or helmet opening is not grasped and then twisted, turned or pulled. When in question, it is a foul.

Roughing the Passer

ARTICLE 9.

- a. No defensive player shall unnecessarily rough a forward passer when it is obvious the ball has been thrown. Illegal actions include but are not limited to:
1. Targeting fouls as noted in Rules 9-1-3 and 9-1-4.
 2. Forcible contact to the head or neck area that does not meet the requirements of Rule 9-1-4 (also reference Rule 9-1-2).
 3. Forcible contact that is avoidable after it is obvious the ball has left the forward passer's hand (**A.R. 9-1-9:I**). (**Exception:** A defensive player who is blocked by a Team A player(s) with a force so that they have no opportunity to avoid contact with the forward passer. However, this does not relieve the defensive player of responsibility for personal fouls as described elsewhere in this section.)
 4. Forcibly driving the forward passer to the ground and landing on them with action that punishes the player.
 5. Any action that is a personal foul as described elsewhere in this section.
- NOTE: For 1, 2 and 4 above, this includes contact to an offensive player in a passing posture.*
- b. When an offensive player is in a passing posture with one or both feet on the ground, no defensive player rushing unabated shall hit them forcibly at the knee area or below. The defensive player also may not initiate a roll or lunge and forcibly hit this opponent in the knee area or below (**A.R. 9-1-9:II, III**).

Exceptions:

1. It is not a foul if the offensive player is a ball carrier or simulated ball carrier not in a passing posture, either inside or outside the tackle box.
2. It is not a foul if the defender grabs or wraps this opponent in an attempt to make a conventional tackle without making forcible contact with the head or shoulder.
3. It is not a foul if the defender is not rushing unabated or is blocked or fouled into this opponent.

PENALTY – The 15-yard penalty is added to the end of the last run when it ends beyond the neutral zone and there is no change of team possession during the down.

Approved Ruling 9-1-9

- I. After forward passer A17 releases the ball, B68 takes two strides and charges into A17, showing no attempt to avoid contact. **RULING:** Roughing the passer. The forward passer is a defenseless player who is vulnerable to injury and must be fully protected. After taking two strides, B68 should be aware that A17 has released the ball and be able to avoid contacting them. [Cited by 9-1-9-a-3]
- II. Quarterback A11 drops back in the pocket and sets up to pass. Just as they release the ball they are hit by end B88 who drives their shoulder into A11's knee. The pass is (a) incomplete; (b) caught by A44 who is tackled after a 12-yard gain to the B-40. **RULING:** Foul by B88 for forcibly hitting the forward passer at the knee or below, in violation of Rule 9-1-9-b. Automatic first down and 15-yard penalty enforced at (a) the previous spot; (b) the B-40, the end of the run by A44. [Cited by 9-1-9-b]
- III. Quarterback A11 drops back in the pocket and sets up to pass. They then scramble to their right, sets up again and is in the passing posture when they are hit by end B88 who drives their shoulder into A11's knee. A11 then pulls the ball in and goes to the ground because of being tackled by B88. **RULING:** Foul by B88, violation of Rule 9-1-9-b. While A11 is technically not a forward passer because they did not release the ball, the action by B88 is a foul under 9-1-9-b because of the vulnerability of A11 as a potential passer in a passing posture. [Cited by 9-1-9-b]

Chop Blocking

ARTICLE 10. There shall be no chop blocking (Rule 2-3-3). (**A.R. 9-1-10:I-V**)

Approved Ruling 9-1-10

- I. On a forward pass play, A75 is blocking B66 at the waist behind the neutral zone. While A75 maintains contact, A47 subsequently blocks B66 at their thigh. **RULING:** Chop block. 15 yards from the previous spot. [Cited by 2-3-3, 9-1-10]
- II. As the flow of the play moves to the left, right tackle A77 is disengaging from their block above the thigh with B50 when A27 blocks B50 at their knee. **RULING:** Chop block, 15 yards. Previous-spot enforcement if the foul occurs behind the neutral zone. [Cited by 2-3-3, 9-1-10]
- III. Immediately after the snap, left guard A65 and left tackle A79 simultaneously block B66, who is in the neutral zone. (a) Both blocks are at the thigh. (b) One contact is at the waist and the other at the knee. **RULING:** (a) Legal blocks for a low-low combination. (b) Foul, chop block. [Cited by 2-3-3, 9-1-10]
- IV. Tight end A87 and wingback A43 are leading the play when both simultaneously block linebacker B17, who is three yards beyond the neutral zone. (a) Both blocks are above the waist. (b) One block is above the waist and the other at the knee. **RULING:** (a) Legal blocks. (b) Foul, chop block. [Cited by 2-3-3, 9-1-10]
- V. After snapping the ball, snapper A54 brushes by nose guard B62 on their way to block a linebacker. A54 makes slight contact with B62, or B62 reaches out and uses their arm to initiate contact with A54. While B62 and A54 are in contact, right guard A68 blocks B62 at the knee from the front. **RULING:** Legal. A54 is not blocking B62. The incidental contact or B62's initiating contact does not constitute part of a combination block, and hence there is no chop block. [Cited by 2-3-3, 9-1-10]

Leverage and Leaping

- ARTICLE 11. a. No defensive player, in an attempt to gain an advantage, may step, jump or stand on an opponent.
- b. It is a foul if a defensive player moves forward and tries to block a kick or apparent kick on a field goal or try by leaving their feet and leaping into the plane directly above the frame of the body of an opponent. It is not a foul if the player was aligned in a stationary position within one yard of the line of scrimmage when the ball was snapped.
 - c. It is a foul if a defensive player who is inside the tackle box tries to block a punt or an apparent punt by leaving their feet and leaping into the plane directly above the frame of the body of an opponent.
 1. It is not a foul if the player tries to block the punt by jumping straight up without attempting to leap over the opponent.
 2. It is not a foul if a player leaps through or over the gap between players.

- d. No defensive player, in an attempt to block, bat or catch a kick or apparent kick, may:
1. Step, jump or stand on a teammate.
 2. Place a hand(s) on a teammate to get leverage for additional height.
 3. Be picked up by a teammate, or be elevated, propelled or pushed.

PENALTY – 15 yards from the previous spot and automatic first down. [S38: PF-LEA]

- e. No player may position themselves with their feet on the back or shoulders of a teammate before the snap. This is unsportsmanlike conduct.

PENALTY – Dead-ball foul. 15 yards from the succeeding spot. Automatic first down for fouls by Team B if not in conflict with other rules [S27: UC-UNS].

Contact Against an Opponent Out of the Play

- ARTICLE 12. a. No player shall tackle or run into a receiver when a forward pass to that receiver is obviously not catchable. This is a personal foul and not pass interference.
- b. No player shall run into or throw themselves against an opponent obviously out of the play either before or after the ball is dead.

Hurdling

ARTICLE 13. There shall be no hurdling (*Exception:* The ball carrier may hurdle an opponent).

Contact Against the Snapper

ARTICLE 14. When a team is in scrimmage kick formation and the snapper is not on the end of the line of scrimmage, a defensive player may not initiate contact with the snapper until one second has elapsed after the snap. (A.R. 9-1-14:I-III)

Approved Ruling 9-1-14

- I. A10 is in a shotgun-type formation 5½ yards behind the snapper, who has their head down and is looking backward through their legs. Immediately after the snap, nose guard B55 charges directly at the snapper and contacts them by pushing them backward. **RULING:** Legal. The snapper is not afforded any special protection because Team A is not in a scrimmage kick formation, since A10 is not at least 7 yards deep (Rule 2-16-10). The snapper does have the usual protection against any personal foul for unnecessary roughness. [Cited by 2-16-10-a, 9-1-14]
- II. Team A is in a scrimmage kick formation with the punter 15 yards behind the line of scrimmage. Immediately after the snap, nose guard B55 charges directly at the snapper, contacts them, and drives them backward. The ball is snapped to an upback three yards behind the scrimmage line or to the potential kicker, who instead runs with or passes the ball. **RULING:** Foul. Penalty — 15 yards and automatic first down. The snapper may not be contacted until one second has elapsed after the snap when Team A is in a scrimmage kick formation. [Cited by 2-16-10-a, 9-1-14]
- III. Immediately after the snap, with Team A in a scrimmage kick formation, B71 is lined up within one yard of the line of scrimmage and is outside of the frame of the snapper. B71 attempts to "shoot the gap" between the snapper and the adjacent lineman. B71's initial legal contact is with the lineman next to the snapper. **RULING:** Legal. Incidental contact with the snapper after this initial legal contact is not a foul (Rule 2-16-10). [Cited by 2-16-10-a, 9-1-14]

Horse-Collar Tackle

ARTICLE 15. All players are prohibited from grabbing the inside back or side collar of the shoulder pads or jersey, the nameplate area of the jersey or above, and abruptly pulling the ball carrier or simulated ball carrier toward the ground. This rule applies to any ball carrier or simulated ball carrier, including a potential forward passer, who is inside or outside the tackle box (Rule 2-34). (A.R. 9-1-15:I).

NOTE: It is not necessary for a player to pull the opponent completely to the ground in order for the act to be illegal. If the opponent's knees are buckled by the action, it is a foul even if they are not pulled completely to the ground.

Approved Ruling 9-1-15

- I. As ball carrier A20 races down the field near the sideline, defender B56 grabs them from behind by the back of the jersey at the collar or by the collar of their shoulder pad. B56 continues with this contact for several yards but A20 does not go to the ground until tackled by another defender. **RULING:** Legal play. B56 did not foul because they did not abruptly pull A20 down. [Cited by 9-1-15]
- II. Ball carrier A20 races down the field. Defender B56 approaches from the side, grabbing A20 by the back of the jersey at the collar or by the collar of their shoulder pad. B56 abruptly pulls A20 towards the ground to the side, or to the direction where A20 was heading. A20's knees are buckled to the side by the pulling action. **RULING:** No foul. Only pulling the runner down and away from the direction they are advancing is a foul. Pulling them to the side or forward is not a foul. [Cited by RA 3]

Roughing or Running into Kicker or Holder

ARTICLE 16. a. When it is obvious that a scrimmage kick will be made, no opponent shall run into or rough the kicker or the holder of a place kick. (**A.R. 9-1-16:I, III and VI**)

1. Roughing is a live-ball personal foul that endangers the kicker or holder.
2. Running into the kicker or holder is a live-ball foul that occurs when the kicker or holder is displaced from their kicking or holding position but is not roughed. (**A.R. 9-1-16:II**)
3. Incidental contact with a kicker or holder is not a foul.
4. The kicker's protection under this rule ends:
 - (a) When the kicker has had a reasonable time to regain their balance (**A.R. 9-1-16:IV**); or
 - (b) When the kicker carries or possesses the ball outside the tackle box (Rule 2-34) before kicking (**A.R. 9-1-16:VII**).
 - (c) When the kicker carries or possesses the ball more than five yards behind the kicker's initial position at the snap from scrimmage kick formation.
5. When a defensive player's contact against the kicker or holder is caused by an opponent's block (legal or illegal), there is no foul for running into or roughing.
6. A player who makes contact with the kicker or holder after touching the kick is not charged with running into or roughing the kicker.
7. When a player other than one who blocks a scrimmage kick runs into or roughs the kicker or holder, it is a foul.
8. When in question whether the foul is *running into* or *roughing*, the foul is *roughing*.

PENALTY – Roughing or any other personal foul against the kicker who is in the act of or just after kicking the ball; or roughing the holder: 15 yards from the previous spot, plus automatic first down if not in conflict with other rules [S38 and S30: PF-RTK/PF-RTH]. Running into the kicker or holder: five yards from the previous spot [S30: RNK/RNH].

- b. A kicker or holder simulating being roughed or run into by a defensive player commits an unsportsmanlike act. (**A.R. 9-1-16:V**)

PENALTY – 15 yards from the previous spot or, if the scrimmage kick crosses the neutral zone, can be enforced where the subsequent dead ball belongs to Team B [S27: UC-SBR].

- c. The kicker of a free kick may not be blocked until they have advanced five yards beyond their restraining line, or until the ball has touched a player, an official or the ground.

PENALTY – 15 yards from the previous spot [S40: PF-RFK].

Approved Ruling 9-1-16

- I. A1 catches a long snap and plans to punt from behind their line of scrimmage, but misses the ball, which falls to the ground. A1 is then contacted by B1. **RULING:** Team A fumble. No foul by B1. There is no kicker until the ball is kicked. [Cited by 9-1-16-a]
- II. A1 kicks the ball, after which B1, unable to stop their attempt to block the kick, makes contact with the kicker or holder. **RULING:** This action could be either "Roughing" or "Running into" the kicker or holder. When in question, the ruling is to be "Roughing", which carries a penalty of 15 yards and an automatic first down. [Cited by 9-1-16-a-2]

- III. A1, from a non-scrimmage kick formation, makes a quick, unexpected kick so suddenly that B1 cannot avoid contact. **RULING:** This is not roughing or running into the kicker, since the rule applies only when it is obvious that a kick will be made. [Cited by 9-1-16-a]
- IV. B1 runs into player A1, who has kicked the ball and has had a reasonable time to regain their balance. **RULING:** Not a foul by B1 unless ruled as running into or throwing themselves against an opponent obviously out of the play (Rule 9-1-12). [Cited by 9-1-16-a-4-a]
- V. After B1 runs into the kicker, kicker A25 simulates being roughed. **RULING:** Offsetting fouls. [Cited by 9-1-16-b]
- VI. Team A is in a scrimmage kick formation. Punter A1 moves laterally two or three steps to recover a faulty snap, or recovers a snap that went over their head, and then kicks the ball. B2 contacts A1 in an unsuccessful attempt to block the kick. **RULING:** A1 does not automatically lose their protection in either case unless they carry or possess the ball outside the tackle box, or has to go back more than 5 yards behind their initial position to recover the ball. While in the tackle box, A1 is entitled to protection as in any other kicking situation. When it becomes obvious that A1 intends to kick in a normal punting position, defensive players must avoid them after they kick the ball. [Cited by 9-1-16-a]
- VII. Punter A22 is 15 yards behind the neutral zone when they catch the long snap, sprints to their right at an angle toward the line of scrimmage, and runs outside the tackle box. They then stop and punt the ball, and (a) is immediately hit by a diving B89; or (b) is immediately hit by B89, and B89 is guilty of targeting. **RULING:** (a) Legal play, no foul by B89. A22 loses their roughing or running-into protection by carrying the ball outside the tackle box. (b) Even though the kicker is outside the tackle box, targeting is a personal foul and the penalty will be enforced at the previous spot. [Cited by 9-1-16-a-4-b]

Continued Participation Without Helmet

ARTICLE 17. A player whose helmet comes completely off during a down may not continue to participate beyond the immediate action in which they are engaged, whether or not they put the helmet back on during the down. (A.R. 9-1-17:I)

Approved Ruling 9-1-17

- I. During a down B55's helmet comes off without a helmet foul by Team A. B55 immediately picks up their helmet, puts it on and continues to chase the ball carrier. **RULING:** Personal foul by B55 for continuing to participate after losing their helmet. The clock stops at the end of the down and B55 must leave the game for the next down (Rule 3-3-10). [Cited by 9-1-17]

Blind-side block

ARTICLE 18. No player shall deliver a blind-side block by attacking an opponent with forcible contact. (*Exceptions:*

1. *against* the ball carrier or simulated ball carrier;
2. *against* a receiver in the act of attempting to make a catch.)

NOTE: In addition, if this action meets all the elements of targeting, it is a blind-side block with targeting (Rules 9-1-3 and 9-1-4). (A.R. 9-1-18:I)

Approved Ruling 9-1-18

- I. B44 intercepts the pass of A12 at the B-20 and turns back up-field on the return. During the return, B21 approaches A88 at midfield from the blind side and blocks A88 (a) with extended hands; (b) with a screen type block; (c) by attacking with forcible contact with their shoulder into the chest of A88; (d) by attacking with forcible contact with the shoulder into the head of A88. B44 returns the pass to the A-20. **RULING:** (a) No foul. (b) No foul. (c) Personal Foul, blind-side block, 15-yard penalty from the spot of the foul. (d) Personal Foul, blind-side block with targeting, 15-yard penalty from the spot of the foul and B21 is disqualified. [Cited by 9-1-18 Exception 2-Note]

SECTION 2. Unsportsmanlike Conduct Fouls

Unsportsmanlike Acts

ARTICLE 1. There shall be no unsportsmanlike conduct or any act that interferes with orderly game administration on the part of players, substitutes, coaches, authorised attendants or any other persons

subject to the rules, before the game, during the game or between periods. Infractions for these acts by players are administered as either live-ball or dead-ball fouls depending on when they occur. **(A.R. 9-2-1:I-X)**

a. Specifically prohibited acts and conduct include:

1. No player, substitute, coach or other person subject to the rules shall use abusive, threatening or obscene language or gestures, or engage in such acts that provoke ill will or are demeaning to an opponent, to game officials or to the image of the game, including but not limited to:
 - (a) Pointing the finger(s), hand(s), arm(s) or ball at an opponent, or imitating the slashing of the throat.
 - (b) Taunting, baiting or ridiculing an opponent verbally.
 - (c) Inciting an opponent or spectators in any other way, such as simulating the firing or brandishing of a weapon or placing a hand by the ear to request recognition.
 - (d) Any delayed, excessive, prolonged or choreographed act by which a player (or players) attempts to focus attention upon themselves.
 - (e) An unopposed ball carrier obviously altering stride when approaching the opponent's goal line or diving into the end zone.
 - (f) A player removing their helmet after the ball is dead and before they are in the team area (**Exceptions:** Team, media or injury timeouts; equipment adjustment; through play; between periods; and during a measurement for a first down).
 - (g) Punching one's own chest or crossing one's arms in front of the chest while standing over a prone player.
 - (h) Going into the stands to interact with spectators, or bowing at the waist after a good play. **(A.R. 9-2-1:IX)**
 - (i) Intentionally removing the helmet while the ball is alive.
 - (j) Dead-ball contact fouls such as pushing, shoving, striking, etc. that occur clearly after the ball is dead and that are not part of the game action. **(A.R. 9-2-1:X)**
 - (k) After the ball is dead, using forcible contact to push or pull an opponent off the pile. **(A.R. 9-2-1:XI)**
 - (l) Feigning an injury.
 - (m) Requesting use of replay when not allowed by rule (Rule 12-1-1-b).

PENALTY – Unsportsmanlike conduct. Live-ball fouls by players: 15 yards [S27: UC-*]. Live-ball fouls by non-players and all dead-ball fouls: 15 yards from the succeeding spot [S7 and S27: UC-*]. Automatic first down for live-ball and dead-ball fouls by Team B if not in conflict with other rules. Flagrant offenders shall be disqualified. [S47: DSQ].

For Team A fouls during free or scrimmage kick plays: Enforcement may be at the previous spot or, if the scrimmage kick crosses the neutral zone, the spot where the subsequent dead ball belongs to Team B (field-goal plays exempted) (Rules 6-1-8 and 6-3-13).

For Team B unsportsmanlike conduct fouls during a legal forward pass play (Rules 7-3-12 and 10-2-2-e): Enforcement is at the end of the last run when it ends beyond the neutral zone and there is no change of team possession during the down. If the pass is incomplete or intercepted, or if there is a change of team possession during the down, the penalty is enforced at the previous spot.

2. After a score or any other play, the player in possession immediately must return the ball to an official or leave it near the dead-ball spot. This prohibits:
 - (a) Kicking, throwing, spinning or carrying (including off the field) the ball any distance that requires an official to retrieve it.
 - (b) Spiking the ball to the ground (**Exception:** A forward pass to conserve time (Rule 7-3-2-f)).

- (c) Throwing the ball high into the air.
- (d) Any other unsportsmanlike act or actions that delay the game.

PENALTY – Unsportsmanlike conduct. Dead-ball foul. 15 yards from the succeeding spot [S7 and S27: UC-*]. Automatic first down for fouls by Team B if not in conflict with other rules. Flagrant offenders shall be disqualified [S47: DSQ].

b. Other prohibited acts include:

1. During the game, coaches, squad members and authorised attendants in the team area shall not be on the field of play or outside the 20-yard lines to protest an officiating decision or to communicate with players or officials without permission from the referee. (*Exception:* Rules 1-2-4-f, 3-3-4-d, 3-3-9-b and 3-5-1). (**A.R. 9-2-1:XII**)
2. No disqualified person shall be in view of the field of play (Rule 9-2-6).
3. No person or mascot subject to the rules, except players, officials and eligible substitutes, shall be on the field of play or end zones during any period without permission from the referee. If a player is injured, attendants may come inbounds to attend them, but they must obtain recognition from an official.
4. No substitute(s) may enter the field of play or end zones for purposes other than replacing a player(s) or to fill a player vacancy(ies). This includes demonstrations after any play (**A.R. 9-2-1:I**).
5. Persons subject to the rules, including bands and audio/video/lighting systems operators, shall not create any noise or distraction that prohibits a team from hearing its signals or obstructs play (Rule 1-1-6).

PENALTY – [1-4] Unsportsmanlike conduct. Dead-ball foul. 15 yards from the succeeding spot [S7 and S27: UC-*]. Automatic first down for fouls by Team B if not in conflict with other rules. Flagrant offenders shall be disqualified [S47: DSQ].

[5] Unsportsmanlike conduct. The referee may take any action they consider equitable, which includes directing that the down be repeated, assessing a 15-yard penalty, awarding a score, or suspending or forfeiting the game [S27: UFA].

Approved Ruling 9-2-1

- I. Team B scores a touchdown on a kickoff return, and substitutes from the Team B area, with no intention of entering the game, run to the end zone to congratulate the ball carrier. **RULING:** Unsportsmanlike act. Penalty — 15 yards, enforced on the try, the succeeding kickoff or from the succeeding spot in extra periods. Officials should note the numbers of the offending players, for possible disqualification later in the game upon committing a second unsportsmanlike conduct foul (9-2-1-b-Penalty). [Cited by 9-2-1, 9-2-1-b-4]
- II. Third and 15 at the B-20. Eligible A88 catches a pass at the B-18 and heads for the goal line. At the B-10 they go into a "goose step" and continue this action as they cross the goal line. **RULING:** Live-ball foul for unsportsmanlike conduct. Fifteen-yard penalty enforced at the spot of the foul, which is the B-10, and repeat third down. Third and 20 at the B-25. [Cited by 9-2-1]
- III. Second and five at the B-40. Back A22 takes a backward pass from the quarterback, circles right end, and heads for the goal line. Guard A66, who had pulled out to lead the play, legally blocks B90 to the ground and then stands over them at the B-30 taunting and screaming obscenities. This draws a flag from the head linesman, when A22 is at the B-10 before continuing into the end zone. **RULING:** Live-ball foul for unsportsmanlike conduct. Fifteen-yard penalty enforced at the spot of the foul, which is the B-30, and repeat second down. Second and 10 at the B-45. [Cited by 9-2-1]
- IV. Third and 15 at the B-20. Eligible A88 catches a pass at the B-18 and heads for the goal line. Very close to the goal line they dive into the end zone, with no Team B player closer than about 10 yards. The field judge is uncertain of the exact spot where A88 started their diving action. **RULING:** Foul for unsportsmanlike conduct. Administer as a dead-ball foul. The touchdown counts and the penalty is enforced on the try, the succeeding kickoff, or from the succeeding spot in extra periods. [Cited by 9-2-1]
- V. Second and seven at the B-30. Nose guard B55 is lined up in the neutral zone at the snap. Back A22 takes the ball on a quick play up the middle, bursts into the open, and at the B-10 they turn around and prance backward into the end zone. The head linesman and the line judge both have flags for the offside

- foul, and the back judge drops their flag for the action by A22. **RULING:** Offsetting fouls, repeat the down. Second and seven at the B-30. [Cited by 9-2-1]
- VI. First and 10 at the 50. The quarterback pitches out to running back A44 who circles right end and races toward the goal line. The line judge trailing the play flags linebacker B57 for screaming obscenities at them, complaining that they were held by the tight end. A44 scores a touchdown. **RULING:** Live-ball unsportsmanlike conduct against B57. The penalty carries over to either the try or the kickoff, at the option of Team A. [Cited by 9-2-1]
- VII. Third and 15 at the A-45. A12 drops back to pass and is sacked by tackle B77 for a 10-yard loss. B77 leaps to their feet, beats their chest, stands over A12 and taunts them, and showboats to the crowd, drawing flags from the referee and the line judge. **RULING:** Dead-ball unsportsmanlike conduct by B77. Fifteen-yard penalty at the dead-ball spot plus automatic first down. First and 10 for Team A at the 50. [Cited by 9-2-1]
- VIII. Safety B33 intercepts a pass at the B-10 and returns for a touchdown. As they are coming down the sideline covering the play, the line judge drops their flag after they run into the Team B head coach who is just on the field of play near the B-40. **RULING:** Although this is a foul that takes place while the ball is alive, it is treated as a dead-ball foul against the team because it is committed by a non-player. The touchdown counts and the 15-yard penalty is enforced on the try, the succeeding kickoff, or from the succeeding spot in extra periods. [Cited by 9-2-1, 9-2-5-b]
- IX. Second and five at the A-45. Ball carrier A33 breaks out into the open and has a clear path to the goal line. At the B-2 they suddenly make a sharp left turn and trot along the B-2 as the Team B players begin to catch up to them. They then carry the ball into the end zone. A33 next runs to the stands and begins to exchange "high-fives" with the fans. **RULING:** Touchdown. A33 is allowed to consume time by delaying the touchdown as long as they are not celebrating or taunting, but A33 is charged with unsportsmanlike conduct for running to the stands. Dead-ball foul. Team B can choose to have the penalty enforced on the try or the subsequent kickoff. [Cited by 9-2-1, 9-2-1-a-1-h]
- X. After the ball carrier is tackled, A55 and B73 engage in a scuffle such that officials have to separate them and throw flags. Both A55 and B73 are charged with dead-ball personal fouls. **RULING:** Dead-ball fouls that cancel. Each player is also charged with an unsportsmanlike conduct foul which counts toward the two such fouls leading to automatic disqualification. The referee announces either the first or second unsportsmanlike conduct foul for A55 and B73. [Cited by 9-2-1, 9-2-1-a-1-j]
- XI. During the play, the ball carrier fumbles and several players dive for the ball. B55 grabs A33 and slings them off the pile. **RULING:** B55 is charged with a foul for unsportsmanlike conduct. 15 yards and automatic first down. The referee announces that this is either the first or second unsportsmanlike conduct foul against B55. If it is the second, B55 is disqualified from the game. [Cited by 9-2-1-a-1-k]
- XII. During a dead-ball time, a head coach or an assistant coach is flagged for coming out to the numbers and cursing the officials in a loud and abusive manner. **RULING:** The officials charge either the head coach or the assistant coach with a foul for unsportsmanlike conduct. The referee announces that this is either the first or second unsportsmanlike conduct foul against the coach in question. If it is the second, the coach in question is disqualified from the game. [Cited by 9-2-1-b-1]

Unfair Tactics

- ARTICLE 2. a. No player shall conceal the ball in or beneath their clothing or equipment or substitute any other article for the ball.
- b. No simulated replacements or substitutions may be used to confuse opponents. No tactic associated with substitutes or the substitution process may be used to confuse opponents (Rule 3-5-2-e) (A.R. 3-5-2:IV) (A.R. 9-2-2:I-VI). This includes any hideout tactic with or without a substitution.
- c. No equipment may be used to confuse opponents (Rule 1-4-2-d).
- d. No unusual action or verbiage may be used by Team A to confuse an opponent into believing the snap or free kick is not imminent. Team A may not advance the ball nor consume more than 3 seconds having indicated to their opponents that they do not intend to advance the ball (a "take-a-knee" play).
- e. No action that simulates an injury may be used to confuse opponents or officials.

PENALTY – [a-e] — Team unsportsmanlike conduct. Live-ball foul. 15 yards from the previous spot [S27: UFT]. Automatic first down for fouls by Team B if not in conflict with other rules. Flagrant offenders shall be disqualified [S47: DSQ].

- f. No more than one squad member may be assigned or wear the same jersey number (*Exception: Non-competitive games*) (A.R. 9-2-2:VII).

PENALTY – Unsportsmanlike conduct charged against the head coach and the players must immediately correct the numbering and report the change. Administer as a dead-ball foul - 15 yards [S27: UC-2PN].

Approved Ruling 9-2-2

- I. After the ball is ready for play, Team A goes into a formation with two players split wide on both sides of the snapper and two other Team A linemen adjacent to the snapper. No more than four players are legally in the backfield. Team A sends in two substitutes, who take positions on the line of scrimmage adjacent to the two split offensive linemen on the opposite side of the field of play from their team bench. This leaves Team A with nine players on the line of scrimmage and four backfield players all legally in position. Immediately and before the snap, two Team A linemen nearest their team's bench leave the field of play and are off at the snap. Seven players are on the line of scrimmage, five of whom are Team A linemen numbered 50 to 79. **RULING:** Penalty — 15 yards from the previous spot. This is a simulated replacement of a player to confuse the opponents. [Cited by 9-2-2-b]
- II. On fourth down at Team B's 12-yard line, A1 enters the field with a kicking shoe while their 11 teammates are in the huddle. A1 kneels and measures the distance from the neutral zone to the kicking spot. While their teammates are leaving the huddle, A1 leaves the field with the shoe. Team A quickly runs a play from scrimmage. **RULING:** Team A foul for unsportsmanlike conduct. Penalty — 15 yards from the previous spot. There shall be no simulated replacement of a player to confuse the opponents, and a player who communicates must remain in the game for one down. [Cited by 9-2-2-b]
- III. A1 leaves the field of play during a down. Team A huddles with 10 players. Substitute A12 enters and A2 simulates leaving the field, but sets near the sideline for a "hide-out" pass. **RULING:** Penalty — 15 yards from the previous spot. This is a simulated replacement of a player to confuse opponents. [Cited by 9-2-2-b]
- IV. While a team is legally set to attempt a field goal, the potential holder for the kick goes toward their team area asking for a shoe. A shoe is thrown on the field and the player, in motion toward their team area, turns toward the goal line. The ball is snapped to the player in the kicking position, who throws a pass to the player who had turned upfield after asking for a shoe. **RULING:** Penalty — 15 yards from the previous spot. [Cited by 9-2-2-b]
- V. Team A is lined up in scrimmage kick formation and has been set for one second. One of the offensive backs shouts to and motions to A40, the blocker on the right wing, to get off the field. At the snap, A40 is in legal motion toward their sideline. A40 turns downfield and becomes a pass receiver. **RULING:** Penalty — 15 yards from the previous spot. This is a tactic associated with the substitution process to deceive opponents. [Cited by 9-2-2-b]
- VI. After the down is over, Team A sends in three substitutes, and three players begin to leave the field. A88, who participated in the previous play trails the three replaced players toward the Team A sideline. The three replaced players continue into the team area, but A88 stops and sets up on the line of scrimmage very close to the sideline. After the ball is snapped A88 runs down the sideline and catches a forward pass. **RULING:** Team A foul at the snap, unsportsmanlike conduct for unfair tactics: using the substitution process to deceive the opponents. Live-ball foul. Penalty — 15 yards from the previous spot. [Cited by 9-2-2-b]
- VII. 4/10 @ A-35. As Team A begins substitutions for a potential punt, it is discovered that Team A has assigned three players wearing the number 2. **RULING:** Unsportsmanlike Conduct charged against the head coach. After enforcement, 4/25 @ A-20. This counts toward the two Unsportsmanlike Conduct fouls that lead to automatic disqualification. [Cited by 9-2-2-f]
- VIII. 4/1 @ B-40. QB A12 moves from shotgun formation to under centre and barks signals in an unsuccessful attempt to draw Team B offside. With 10 seconds remaining on the play clock, A12 backs away from the centre and jogs toward the sideline being very demonstrative with his arms and waiving to the bench. As A12 approaches the sideline, the ball is snapped directly to back A44 just before the play clock expires and A44 runs to the B-38. **RULING:** Team A, 4/16 @ A-45 -Unsportsmanlike Conduct by A12; penalise Team A 15 yards from the previous spot. The action by A12 is in violation of the spirit of Rule 9-2-2-b.

Unfair Acts

ARTICLE 3. The following are unfair acts:

- a. A team refuses to play within two minutes after ordered to do so by the referee.
- b. A team repeatedly commits fouls for which penalties can be enforced only by halving the distance to its goal line.
- c. An obviously unfair act not specifically covered by the rules occurs during the game. This includes substitutes, coaches or any other persons subject to the rules, other than a player or official, interfering in any way with the ball or a player while the ball is in play (**A.R. 4-2-1:II**) (**A.R. 9-2-3:I-IV**).

PENALTY – Unsportsmanlike conduct. The referee may take any action they consider equitable, which includes directing that the down be repeated, assessing a 15-yard penalty, awarding a score, or suspending or forfeiting the game [S27: UFA].

Approved Ruling 9-2-3

- I. After the ball is ready for play and the umpire (or centre judge) is in their regular position, Team A quickly replaces some players with substitutes, gets set for the required one second and snaps the ball. The umpire (or centre judge) is attempting to get to the ball to allow the defense to match up, but they are unable to prevent the snap. **RULING:** The play is shut down, the game clock is stopped and the defense is allowed to substitute in response to Team A's late substitutions. **Team A will be penalised 5 yards for delay of game.** The play clock is set to 25 seconds and starts on the ready-for-play signal. The game clock starts on the ready-for-play signal or the snap, depending on its condition when play was stopped. × (see also **A.R. 3-5-2:V**). [Cited by 9-2-3-c]
- II. Team A, trailing by nine points, has 1st-and-10 on the B-22 with 0:35 showing on the game clock. At the snap, B21, B40 and B44 blatantly hold, wrapping both arms around Team A's wideouts and take them to the ground. Quarterback A12 has no receiver in the route, scrambles and then legally throws the ball away. After the play, the game clock reads 0:26. The back judge, field judge and side judge have a flag down for Team B holding on each of their keys. **RULING:** This is a blatant and obvious unfair act designed to take time off the clock. The referee will convert the holding fouls to unsportsmanlike conduct fouls. Penalise half the distance to the goal. Team A will have 1st and 10 at the B-11. The game clock is reset to 0:35 and starts on the next snap. B21, B40 and B44 each have one unsportsmanlike foul counter. [Cited by 9-2-3-c]
- III. Team A, ahead in the score by four points, has 4th-and-10 at the A-30 with 0:14 seconds remaining in the game. From a shotgun formation, A12 receives the snap, retreats back toward their own goal line, and moves out of the tackle box. At the snap, each Team A lineman blatantly holds the Team B player in front of them, preventing the defensive linemen from immediately rushing the passer. When rushers approach A12, they throw the ball high so that it lands beyond the line of scrimmage and out of bounds. When the pass hits the ground, the game clock reads 0:00. The umpire, centre judge (if applicable) and referee each have a flag on the ground for holding on Team A. **RULING:** This is a blatant and obvious unfair act designed to take time off the clock. The referee will convert the holding fouls to unsportsmanlike conduct fouls. Penalise Team A 15 yards from the previous spot. Team A will have 4th and 25 at the A-15. The game clock is reset to 0:14 and starts on the next snap. Each Team A lineman guilty of holding will have one unsportsmanlike foul counter. [Cited by 9-2-3-c]
- IV. 1/10 @ A-25 with 0:01 remaining in the game and Team A trails by 5 points. A12 throws a pass that is complete to A88 at midfield. After the catch by A88, there are a series of legal backwards passes keeping the ball alive in Team A possession. Eventually A21 laterals the ball toward teammate A44, and the ball hits the ground with no recovery. The Team B bench thinking that the ball is dead rushes the field and many squad members are on the field. A44 recovers the ball and begins running and encounters heavy traffic with the Team B squad members on the field, reverses field and is finally tackled by B50 at the B-30. **RULING:** No substitute, coach or any person subject to the rules, other than a player or official may interfere in any way with the ball or a player while the ball is in play. This unfair act will be penalised 15 yards as a live-ball foul. The referee may enforce any penalty that they consider equitable, including awarding a score. [Cited by 9-2-3-c]

Contacting an Official

ARTICLE 4. Persons subject to the rules (Rule 1-1-6) shall not intentionally contact a game official forcibly during the game.

PENALTY – Unsportsmanlike conduct. Administer as a dead-ball foul. 15 yards from the succeeding spot and automatic disqualification. Automatic first down for fouls by Team B if not in conflict with other rules [S7, S27 and S47: UC-FCO/DSQ].

Game Administration and Sideline Interference

ARTICLE 5. While the ball is alive and during the continuing action after the ball has been declared dead:

- a. Coaches, substitutes and authorised attendants in the team area must be behind the coaching line (A.R. 9-2-5:III).

PENALTY – Administer as a dead-ball foul.

First infraction: Warning for sideline interference. No yardage penalty. [S15: SLW]

Second and third infractions: Delay of game for sideline interference, five yards from the succeeding spot. [S21 and S29: SLI]

Fourth and subsequent infractions: Team unsportsmanlike conduct for sideline interference, 15 yards from the succeeding spot. Automatic first down for fouls by Team B if not in conflict with other rules. [S27 and S29: SLM]

- b. Physical interference with an official is a foul for unsportsmanlike conduct charged to the team unless the individual can be readily identified. (A.R. 9-2-5:I-II) (A.R. 9-2-1:VIII)

PENALTY – Team unsportsmanlike conduct unless the individual can be readily identified.

Administer as a dead-ball foul. 15 yards from the succeeding spot. Automatic first down for fouls by Team B if not in conflict with other rules. [S27: UNS]

Approved Ruling 9-2-5

- I. On the opening kickoff, B22 catches the kick at their goal line and returns the ball down the sideline on Team B's side of the field. As they move down the sideline officiating the play, the side judge either runs into or must run around a Team B coach or squad member in the restricted area ("the white"). B22 is driven out of bounds at the A-20. **RULING:** Either situation is physical interference with an official during the play. No warning. Foul for unsportsmanlike conduct administered as a dead-ball foul. If the Team B coach or squad member is readily identifiable, the unsportsmanlike conduct is charged to that individual. If the coach or player is not identified, it is a team unsportsmanlike conduct foul. After the 15-yard penalty, Team B will have first and 10 at the A-35. [Cited by 9-2-5-b]
- II. During a long kickoff return, the Side Judge has to stop and run around the head coach who is out of the coaching box in the restricted area or on the field of play near the sideline. **RULING:** Administer as a dead-ball foul. Penalise 15 yards at the succeeding spot. Foul charged against the head coach and this will be considered an unsportsmanlike conduct counting toward the two unsportsmanlike conduct fouls resulting in ejection. [Cited by 9-2-5-b]
- III. During a long kickoff return, the head coach and/or other coaches are outside the coaching box and are in the restricted area or on the field of play near the sideline. No physical interference is made with an official during the play. **RULING:** Administer as a dead-ball foul.
First infraction: Warning for sideline interference. No yardage penalty.
Second and third infractions: Delay of game for sideline interference, five yards from the succeeding spot.
Fourth and subsequent infractions: Team unsportsmanlike conduct foul for sideline interference unless the individual is readily identifiable. Penalise 15 yards at the succeeding spot. This is a team foul, and is not charged as an unsportsmanlike conduct foul against any coach. [Cited by 9-2-5-a]

Disqualified players and coaches

ARTICLE 6. a. Any coach, player or identified squad member in uniform who commits two unsportsmanlike conduct fouls in the same game shall be disqualified (A.R. 9-2-6:I-II).

- b. A player disqualified from the game (Rule 2-27-12) must leave the playing enclosure (Rule 2-31-5) under team supervision within a reasonable amount of time after their disqualification. They must remain out of view of the field of play under team supervision for the remainder of the game.
- c. A coach disqualified from the game must leave the playing enclosure within a reasonable amount of time after the disqualification and must remain out of view of the field of play for the remainder of the game.
- d. A head coach disqualified from the game may designate a new head coach. **(A.R. 9-2-6:I)**

Approved Ruling 9-2-6

- I. During a long kickoff return, the head coach of the kicking team comes onto the field of play, vigorously and angrily protesting that there should have been a flag for holding by the receiving team during the return. **RULING:** Unsportsmanlike conduct foul against the head coach. Administer as a dead-ball foul. Penalise 15 yards at the succeeding spot. This counts as one of the unsportsmanlike conduct fouls against the head coach. If this were their second foul for unsportsmanlike conduct, the head coach would be disqualified from the game. A head coach disqualified from the game may designate a new head coach. [Cited by 9-2-6-a, 9-2-6-d]
- II. During the first half, player A18 is penalised for (a) illegally marking the ball; (b) entering the game without reporting to the referee after changing his jersey number; or (c) simulating being roughed. In the second half, A18 is again penalised, this time for taunting an opponent. **RULING:** In each case, A18 is disqualified for committing two unsportsmanlike conduct fouls in the same game. The set of fouls that count towards this includes all the individual 15-yard penalty unsportsmanlike fouls in Rules 1-3-3, 1-4-2-d, 9-1-11-e, 9-1-16-b and 9-2. It does not include team unsportsmanlike conduct fouls specified in Rules 1-4-5-b-3, 1-4-5-c-2, 3-5-2-e and 9-2. [Cited by 9-2-6-a]

Removing persons from the playing enclosure

ARTICLE 7. The referee may require game management to remove any person from the playing enclosure (Rule 2-31-5) who they believe poses a threat to the safety of persons subject to the rules or the officials, or whose behaviour is prejudicial to the orderly conduct of the game. The referee may suspend the game (Rule 3-3-3-a) while this takes place **(A.R. 9-2-7:I)**.

Approved Ruling 9-2-7

- I. During the game, (i) a player; (ii) a coach; (iii) a squad member in the team area, is observed to be obviously intoxicated (due to drugs including alcohol). **RULING:** In each case, the referee may require game management to remove them from the playing enclosure. [Cited by 9-2-7]

SECTION 3. Blocking, Use of Hands or Arms

Who May Block

ARTICLE 1. Players of either team may block opponents, provided it is not pass interference, interference with the opportunity to catch a kick, or a personal foul (**Exception:** Rules 6-1-12 and 6-5-4).

Interfering for or Helping the Ball Carrier or Passer

- ARTICLE 2. a. The ball carrier or forward passer may use their hand or arm to ward off or push opponents.
- b. The ball carrier shall not grasp a teammate; and no other teammate shall grasp, pull, or lift the ball carrier to assist in forward progress. **(A.R. 9-3-2:I)**
 - c. Teammates of the ball carrier or forward passer may interfere with opponents by blocking but shall not use interlocked interference by grasping or encircling one another in any manner while contacting an opponent.

PENALTY – Five yards [S44: ATR].

Approved Ruling 9-3-2

- I. In trying to gain yardage, ball carrier A44 is slowed by defensive players attempting to make the tackle. Back A22 (a) puts their hands on the buttocks of A44 and pushes them forward; (b) pushes the pile of teammates who begin to surround A44; (c) grabs the arm of A44 and tries to pull them forward for more yardage. **RULING:** (a) and (b) Legal. It is not a foul to push the ball carrier or the pile. (c) Foul for assisting the runner. Five-yard penalty with three-and-one enforcement (Rule 9-3-2-b). [Cited by 9-3-2-b]

Holding and Use of Hands or Arms: Offense**ARTICLE 3. a. Use of hands**

A teammate of a ball carrier or a forward passer legally may block with their shoulders, their hands, the outer surface of their arms or any other part of their body under the following provisions.

1. The hand(s) shall be:
 - (a) In advance of the elbow.
 - (b) Inside the frame of the opponent's body (**Exception:** When the opponent turns their back to the blocker). (**A.R. 9-3-3:V-VII**)
 - (c) At or below the shoulder(s) of the blocker and the opponent (**Exception:** When the opponent squats, ducks or submarines).
 - (d) Apart and never in a locked position.
2. The hand(s) shall be open with the palm(s) facing the frame of the opponent or closed or cupped with the palms not facing the opponent. (**A.R. 9-3-3:I-IV, VI-VIII**)

b. Holding

The hand(s) and arm(s) shall not be used to grasp, pull, hook, clamp or encircle in any way that illegally impedes or illegally obstructs an opponent.

PENALTY – 10 yards. Penalties for Team A fouls behind the neutral zone are enforced from the previous spot. Safety if the foul occurs behind Team A's goal line [S42: IUH/OFH].

c. Kicking team

A player on the kicking team may:

1. During a scrimmage kick play, use their hand(s) and/or arm(s) to ward off an opponent attempting to block them when they are beyond the neutral zone.
2. During a free kick play, use their hand(s) and/or arm(s) to ward off an opponent who is attempting to block them.
3. During a scrimmage kick play or a free kick play, when they are eligible to touch the ball, legally use their hand(s) and/or arm(s) to push an opponent in an attempt to reach a loose ball.

d. Passing team

An eligible player of the passing team legally may use their hand(s) and/or arm(s) to ward off or push an opponent in an attempt to reach a loose ball after a legal forward pass has been touched by any player or official (Rules 7-3-5, 7-3-8, 7-3-9 and 7-3-11).

Approved Ruling 9-3-3

- I. A6 is advancing the ball. During the run, A12 vigorously blocks B2 with a rough **extended hands** push in the back above the waist. **RULING:** Illegal block in the back. Penalty — 10 yards. [Cited by 2-3-4-a, 9-3-3-a-2, 9-3-5]
- II. A teammate of the forward passer or ball carrier, while charging across the neutral zone, contacts an opponent with their hands and arms not parallel to the ground or their hands cupped or closed but with the palms not facing the opponent. **RULING:** Legal use of hands. [Cited by 9-3-3-a-2]
- III. A teammate of the forward passer or ball carrier, behind the neutral zone, has their arms parallel to the ground and contacts an opponent above the shoulders. **RULING:** Illegal use of hands. Penalty — 10 yards or 15 yards for personal foul, previous-spot enforcement. Safety if the foul occurs behind Team A's goal line. [Cited by 9-3-3-a-2]

- IV. A teammate of the forward passer or ball carrier delivers a blow with the hand(s) closed to an opponent below the shoulders. **RULING:** Personal foul. Penalty — 15 yards. Enforce at the previous spot if foul occurs behind the neutral zone. Safety if the foul occurs behind Team A's goal line. [Cited by 9-3-3-a-2]
- V. A2's hands contact defensive player B2 in a legal block. B2 spins to avoid blocker A2 whose hands then contact B2's back. **RULING:** Legal block. [Cited by 2-3-4-a, 9-3-3-a-1-b]
- VI. A2's hands contact defensive player B2's back when B2 spins to avoid A2. A2 keeps their hands on B2's back while B2 advances toward the forward passer. **RULING:** Legal block. [Cited by 2-3-4-a, 9-3-3-a-1-b, 9-3-3-a-2]
- VII. A2's hands contact defensive player B2 when B2 spins to avoid blocker A2, whose hands then contact B2's back. After A2's hands lose contact with B2, A2 advances and pushes B2 in the back. **RULING:** Illegal block in the back. Penalty — 10 yards. Enforce at the previous spot if the foul occurs behind neutral zone (Rule 2-3-4). Safety if the foul occurs behind Team A's goal line. [Cited by 2-3-4-a, 9-3-3-a-1-b, 9-3-3-a-2, 9-3-5]
- VIII. A1 in, beyond or behind the neutral zone contacts an opponent with an open hand or with hands closed or cupped and palms not facing the opponent. **RULING:** Legal block. [Cited by 9-3-3-a-2]
- IX. A12 takes the snap and retreats to pass. Defensive end B95 gets past tackle A75 and is about to tackle A12, who is still inside the tackle box. A75 pushes B95 in the back at the numbers to prevent them from making the tackle. A12's pass is complete for a touchdown. **RULING:** Foul for an illegal block in the back. Penalty — 10 yards. [Cited by 2-3-4-a, 9-3-5]

Holding and Use of Hands or Arms: Defense

ARTICLE 4. a. Defensive players may use hands and arms to push, pull, ward off or lift offensive players:

- 1. When attempting to reach the ball carrier or simulated ball carrier
- 2. Who are obviously attempting to block them.
- b. A defensive player legally may use their hands or arms to ward off or block an opponent in an attempt to reach a loose ball (Rule 9-1-5 Exceptions 3 and 4 and Rule 9-3-5 Exceptions 3 and 5):
 - 1. During a backward pass, fumble or kick that they are eligible to touch.
 - 2. During any forward pass that crossed the neutral zone and has been touched by any player or official.
- c. When making no attempt to get at the ball or the ball carrier or simulated ball carrier, defensive players must comply with Rules 9-3-3-a and 9-3-3-b above.
- d. Defensive players may not use hands and arms to tackle, hold or otherwise illegally obstruct an opponent other than a ball carrier or simulated ball carrier (**A.R. 9-3-4:II-IV**).
- e. Defensive players may ward off or legally block an eligible pass receiver until that player occupies the same yard line as the defender or until the opponent could not possibly block them. Continuous contact is illegal. (**A.R. 9-3-4:I**)

PENALTY – [c-e] 10 yards plus automatic first down if the first down is not in conflict with other rules [S42: IUH/DEH].

Approved Ruling 9-3-4

- I. Before a legal forward pass that crosses the neutral zone is thrown, Team B holds eligible A1, who is beyond the neutral zone. **RULING:** Team B foul, holding. Penalty — 10 yards and automatic first down, previous-spot enforcement. [Cited by 9-3-4-e]
- II. 3/15 @ B-45. QB A12 drops back and looks downfield for A88 who is the primary receiver and defender B21 is holding A88 at the B-35. A12 throws a forward pass to his checkdown receiver A44 but the ball falls incomplete at the B-46. **RULING:** Team A, 1/10, B-35, game clock starts on the snap. The penalty for B21's holding foul is enforced 10 yards from the previous spot and an automatic first down. Holding by defense carries an automatic first down. [Cited by 9-3-4-d]
- III. 4/12 @ A-35. Team A lines up in scrimmage kick formation and intends to punt. Immediately after the snap, B55 grabs RT A77 and pulls him to the side and B21 shoots the gap in an attempt to block the punt. The punter gets the punt away and the ball is downed at the B-35. **RULING:** Holding by B55. This foul occurred before the kick and the penalty is not governed by postscrimmage kick enforcement. The 10-yard penalty will be enforced from the previous spot and includes an automatic first down. Team A will have 1/10 @ A-45. [Cited by 9-3-4-d]

- IV. 4/12 @ A-35. Team A lines up in scrimmage kick formation with gunner A88 flanked out to the right side of the formation. After the snap, B21 jams gunner A88 and then holds him as A88 tries to work free down the field during the kick. The punt is downed at the B-35. **RULING:** Holding by B21. The penalty for this foul is governed by postscrimmage kick enforcement and the postscrimmage kick spot serves as the basic spot for enforcement. The 10-yard penalty will be enforced from the end of the kick. Team B will have 1/10 @ B-25. [Cited by 9-3-4-d]

Blocking in the Back

ARTICLE 5. A block in the back (other than against the ball carrier) is illegal. (A.R. 9-3-3:I, VII and IX) (A.R. 10-2-2:XII)

Exceptions:

1. Offensive players who are on the line of scrimmage at the snap within the free-blocking zone (Rule 2-3-6) may legally block in the back in the free-blocking zone, subject to the following restrictions:
 - (a) A player on the line of scrimmage within this free-blocking zone may not leave the zone, return and block in the back.
 - (b) The free-blocking zone disintegrates when the ball leaves the zone (Rule 2-3-6).
2. When a player turns their back to a potential blocker who has committed themselves in intent and direction of movement.
3. When a player attempts to reach a ball carrier or simulated ball carrier or legally attempts to recover or catch a fumble, a backward pass, a kick or a touched forward pass, they may push an opponent in the back above the waist (Rule 9-1-5 Exception 3).
4. When the opponent turns their back to the blocker under Rule 9-3-3-a-1-b.
5. When an eligible player behind the neutral zone pushes an opponent in the back above the waist to get to a forward pass (Rule 9-1-5 Exception 4).

PENALTY – 10 yards. Penalties for Team A fouls behind the neutral zone are enforced from the previous spot. Safety if the foul occurs behind Team A’s goal line [S43: IBB].

SECTION 4. Batting and Kicking

Batting a Loose Ball

ARTICLE 1. a. While a pass is in flight, only a player who is eligible to touch the ball may bat it in any direction (*Exception:* Rule 9-4-2).

- b. Any player may block a scrimmage kick in the field of play or the end zone.
- c. No player shall bat other loose balls forward in the field of play or in any direction if the ball is in the end zone (Rule 2-2-3-a) (*Exception:* Rule 6-3-11). (A.R. 6-3-11:I) (A.R. 9-4-1:I-X) (A.R. 10-2-2:II)

PENALTY – 10 yards and loss of down for fouls by Team A if the loss of down is not in conflict with other rules [S31 and S9: BAT]. [Exception: No loss of down if the foul occurs when a legal scrimmage kick has crossed the neutral zone].

Approved Ruling 9-4-1

- I. Team A attempts a field goal from Team B’s 30-yard line. A Team B player in the end zone leaps above the crossbar and bats the ball in flight. The ball goes into the end zone and is recovered by Team A. **RULING:** Foul for batting the ball in the end zone. The result of the play is a touchdown. [Cited by 9-4-1-c]
- II. Team A attempts a field goal from Team B’s 30-yard line. A Team B player in the end zone leaps above the crossbar and bats the ball in flight. The ball goes into the end zone and is recovered by Team B. **RULING:** Foul for batting the ball in the end zone. The result of the play is a touchback. Safety if penalty is accepted. [Cited by 9-4-1-c]

- III. Team A attempts a field goal from Team B's 30-yard line. A Team B player in the end zone leaps above the crossbar and bats the ball in flight. The ball goes into the field of play. **RULING:** Foul for batting the ball in the end zone. During regulation play, postscrimmage kick enforcement gives a safety by penalty. The ball remains alive, and normal scrimmage kick rules apply. Team A may elect the result of the play. If Team A recovers, does not score and accepts the penalty, or if the play occurs in an extra period, enforcement is at the previous spot. [Cited by 9-4-1-c]
- IV. Team A attempts a place kick on the try. A Team B player in the end zone leaps above the crossbar and bats the ball in flight. The ball goes out of bounds in the end zone. **RULING:** Foul for batting the ball in the end zone. Penalty — Half the distance from the previous spot. Postscrimmage kick rules do not apply on the try (Rule 10-2-3). [Cited by 9-4-1-c]
- V. Team A attempts a place kick on the try. A Team B player in the end zone leaps above the crossbar and bats the ball in flight. The ball goes into the end zone and is recovered by Team A. **RULING:** Foul for batting the ball in the end zone. Team A may decline the penalty and scores two points. [Cited by 9-4-1-c]
- VI. Team A attempts a field goal, and B23, in the end zone, goes above the crossbar and catches the ball. **RULING:** Legal play. [Cited by 9-4-1-c]
- VII. Team A's fumble in flight is batted forward by B1, and the ball goes out of bounds behind Team A's goal line. **RULING:** Safety. Batting a fumble in flight does not add a new impetus (Rule 8-7-2-b). Team B foul. Penalty — 10 yards. [Cited by 9-4-1-c]
- VIII. Team A's backward pass in flight is batted by B1, and the ball goes out of bounds behind Team A's goal line. **RULING:** Safety. A pass may be batted in any direction and the impetus is charged to Team A's pass (Rule 8-5-1-a). [Cited by 8-5-1-a, 9-4-1-c]
- IX. A free kick is muffed in flight by a Team B player in their end zone. While the ball is loose in the end zone, a Team B player bats the ball out of the end zone. **RULING:** The result of the play is a touchback. Team B foul for illegally batting a ball in the end zone. Penalty — 10 yards from the previous spot. [Cited by 9-4-1-c]
- X. After intercepting a legal forward pass at the B-20, B1 fumbles at the B-38. At the B-30, B2 illegally bats the loose ball, which goes forward and out of bounds. **RULING:** Team B foul. Penalty — 10-yards from the spot of the foul. Team B's ball, first and 10 at the 20-yard line. No loss of down is included in the penalty since Team B is awarded a new series after the penalty enforcement (Rule 5-1-1-e-1). [Cited by 9-4-1-c]
- XI. Team A is prepared to kick off. The ball is on the tee and the referee has signaled it ready for play. As the kicker approaches the ball it begins to roll off the tee just as they start their kicking motion. The kicker follows through and kicks the ball as it continues to roll off or near the tee. **RULING:** No foul. This is not a violation of either 9-4-4 or 9-2-1-a-2-a. The officials should stop play and have the teams line up for a new kickoff. If weather conditions dictate, Team A should have a player hold the ball on the tee. [Cited by 9-4-4]

Batting a Backward Pass in Flight

ARTICLE 2. A backward pass in flight shall not be batted forward by the passing team.

PENALTY – 10 yards [S31: BAT].

Batting Ball in Possession

ARTICLE 3. A ball in player possession may not be batted forward by a player of that team.

PENALTY – 10 yards [S31: BAT].

Illegally Kicking a Ball

ARTICLE 4. A player shall not kick a loose ball, a forward pass or a ball being held for a place kick by an opponent. These illegal acts do not change the status of the loose ball or forward pass; but if the player holding the ball for a place kick loses possession during a scrimmage down, it is a fumble and a loose ball; if during a free kick, the ball remains dead (A.R. 8-7-2:IV) (A.R. 9-4-1:XI) (A.R. 9-4-4:I).

PENALTY – 10 yards, plus loss of down for fouls by Team A if the loss of down is not in conflict with other rules [S31 and S9: IKB] (Exception: No loss of down if the foul occurs when a legal scrimmage kick has crossed the neutral zone).

Approved Ruling 9-4-4

- i. Fourth and eight at the A-48. From a scrimmage kick formation, A32 punts the ball to the B-7 where it hits B25 on the leg. As the ball rolls along the ground, B25 then kicks it at the B-4 to prevent Team A from recovering. The ball bounces into Team B's end zone and over the end line. **RULING:** The result of the play is a safety, as B25's kicking the ball provides new impetus. Foul by B25 for illegally kicking the ball. Team A may decline the penalty and take the two points, or accept the penalty. The foul by B25 is governed by postscrimmage kick rules, so the accepted penalty would give Team B the ball at the B-2, first down and 10 (Rules 8-5-1-a and 8-7-2-b). [Cited by 9-4-4]

SECTION 5. Fighting

ARTICLE 1. a. Before, during and after the game, including the half-time intermission, squad members in uniform or coaches shall not participate in a fight (Rule 2-32-1).

PENALTY – 15 yards. For dead-ball fouls, 15 yards from the succeeding spot. Automatic first down for Team B fouls if not in conflict with other rules. Disqualification for the remainder of the game [S7, S27 or S38, and S47: FGT/DSQ].

- b. During either half, coaches and substitutes shall not leave their team area to participate in a fight, nor shall they participate in a fight in their team area.

PENALTY – 15 yards from the succeeding spot. Automatic first down for Team B fouls if not in conflict with other rules. Disqualification for the remainder of the game and the next game [S7, S27 or S38, and S47: FGT/DSQ].

ARTICLE 2. The referee will notify (in writing) their assigning agency of all disqualifications for fighting. The assigning agency becomes responsible for implementation of the penalty.

SECTION 6. Flagrant Fouls**Player Disqualification**

ARTICLE 1. When a player is disqualified from the game due to a flagrant personal foul (Rule 2-10-3), or flagrant unsportsmanlike conduct, the disciplinary authority shall where possible initiate a video review for possible additional sanctions before the next scheduled game.

Foul Not Called

ARTICLE 2. If subsequent review of a game by the disciplinary authority reveals plays involving flagrant personal fouls or flagrant unsportsmanlike conduct that game officials did not call, the disciplinary authority may impose sanctions prior to the next scheduled game.

RULE 10

Penalty Enforcement

SECTION 1. Penalties Completed

How and When Completed

- ARTICLE 1. a. A penalty is completed when it is accepted, declined, offset or cancelled according to rule, or when the choice is obvious to the referee.
- b. Any penalty may be declined, but a disqualified player must leave the game whether the penalty is accepted or declined (Rule 2-27-12).
- c. When a foul is committed, the penalty shall be completed before the ball is declared ready for play for any ensuing down.
- d. Penalties as stated are not enforced if in conflict with other rules.

Simultaneous with Snap

ARTICLE 2. A foul that occurs simultaneously with a snap or free kick is considered as occurring during that down (*Exception:* Rule 3-5-2-e).

Live-Ball Fouls by the Same Team

ARTICLE 3. When two or more live-ball fouls by the same team are reported to the referee, the offended team may elect only one of these penalties. Any player who commits a foul that mandates disqualification must leave the game.

Offsetting Fouls

ARTICLE 4. If live-ball fouls by both teams are reported to the referee, the fouls offset and the down is repeated. (**A.R. 10-1-4:I and VII**) Any player who commits a foul that mandates disqualification must leave the game.

Exceptions:

1. When there is a change of team possession during a down, and the team last gaining possession had not fouled before last gaining possession, it may refuse offsetting fouls and thereby retain possession after completion of the penalty for its foul. (**A.R. 10-1-4:II-VII**)
2. When all Team B fouls that occur before possession changes are governed by postscrimmage kick rules, Team B may refuse offsetting fouls and accept postscrimmage kick enforcement.
3. Rule 10-2-7-c (during a try or extra period after Team B possession).

Approved Ruling 10-1-4

- I. On a Team A kickoff, Team B fouls before the untouched ball goes out of bounds between the goal lines. **RULING:** Offsetting fouls. Team A re-kicks at the previous spot. [Cited by 10-1-4]
- II. On a Team A kickoff from its 35-yard line, Team B commits a personal foul after the untouched ball goes out of bounds between the goal lines. **RULING:** Team B may elect a repeat with Team A free-kicking at its 45-yard line. If Team B retains the ball, it will be at its 20-yard line, after the 15-yard penalty from its 35-yard line, or 15 yards behind the spot where the five-yard penalty against Team A left the ball (Rules 6-1-8 and 10-1-6). [Cited by 10-1-4 Exception 1]
- III. Team A is in an illegal formation at the snap. A1's forward pass is intercepted by B1, who advances five yards and is tackled. Team B clips during B1's run. **RULING:** Team B has the option to accept offsetting fouls and repeat the down or to decline offsetting fouls and retain the ball after its penalty is completed. In the latter case Team A may accept or decline the penalty for Team B's clipping foul. [Cited by 10-1-4 Exception 1, 5-2-8]

- IV. A1 throws an illegal forward pass and Team B is in the neutral zone at the snap. B23 intercepts the pass and B10 clips on the return. B23 is tackled in the field of play. **RULING:** No option. The fouls offset and the down is repeated. Team B may not decline offsetting fouls because it had fouled before getting possession of the ball. [Cited by 10-1-4 Exception 1, 5-2-8]
- V. A1's forward pass is intercepted by B1, who advances and fumbles. B2 recovers and returns the ball five more yards. Team A fouls during or after the down, and Team B fouls during the fumble or during the return by B2. **RULING:** If Team A's foul was a live-ball foul, Team B may select offsetting fouls and repeat the down or select an option to retain the ball following the completion of the penalty for its foul. If Team A's foul was a dead-ball foul, Team B retains the ball after enforcement of both penalties. [Cited by 10-1-4 Exception 1, 5-2-8]
- VI. Team A's legal forward pass is intercepted by B45, who advances several yards. On the return, B23 clips and A78 tackles B45 by pulling and twisting their face mask. **RULING:** Since Team B had not fouled before the change of possession, it may decline offsetting fouls and retain possession after completion of the clipping penalty. [Cited by 10-1-4 Exception 1, 5-2-8]
- VII. A1 receives the snap while standing on their end line. Team B is offside at the snap. **RULING:** Team A's foul, out of bounds at the snap, offsets Team B's offside, and the down is repeated. [Note: If Team B had not been offside, Team B could accept the penalty for Team A's foul or a safety (Rule 8-5-1-a)]. [Cited by 10-1-4, 10-1-4 Exception 1, 5-2-8]

Dead-Ball Fouls

ARTICLE 5. Penalties for dead-ball fouls are administered separately and in order of occurrence (**A.R. 10-1-5:I-III**) [*Exception:* When dead-ball unsportsmanlike or dead-ball personal fouls by both teams are reported to the referee and none of the penalties have been completed, the yardage penalties cancel and the number or type of down established before the fouls occurred is unaffected. Any disqualified player must leave the game (Rules 5-2-6 and 10-2-2-a)].

Approved Ruling 10-1-5

- I. With fourth and eight, Team A gains four yards and the ball is declared dead, after which B1 is called for piling on. **RULING:** Team B personal foul. Penalty — 15 yards from the succeeding spot. First and 10 for Team B (Rule 5-1-1-c). The clock starts on the snap. [Cited by 10-1-5, 5-1-1-c, 5-2-6]
- II. A personal foul occurs during action after a snap infraction that was made before the ball was ready for play. **RULING:** Every effort should be made to prevent any such premature snap and resulting action, but if such a foul does occur, it is between downs. Both penalties are enforced. If the personal foul is by Team B, there is likely a net gain of 10 yards for Team A. The penalty for Team B's foul carries an automatic first down. [Cited by 10-1-5, 5-2-6]
- III. Second and goal at the three-yard line. Ball carrier A14 is downed at the one-yard line and then B67 piles on. A14 retaliates by punching B67. **RULING:** The penalties cancel since neither has been completed. A14 is disqualified for fighting. Third and goal (Rule 10-1-1). [Cited by 10-1-5, 5-2-6]

Live-Ball – Dead-Ball Fouls

ARTICLE 6. a. Live-ball fouls do not offset dead-ball fouls.

- b. When a live-ball foul by one team is followed by one or more dead-ball fouls (including live-ball fouls treated as dead-ball fouls) by an opponent or by the same team, the penalties are administered separately and in the order of occurrence. (**A.R. 10-1-6:I-VI**)

Approved Ruling 10-1-6

- I. Team A punts and is illegally in motion at the snap. The untouched ball goes out of bounds between the goal lines, after which Team B commits a personal foul. **RULING:** Possible options: (1) If Team B elects to repeat the down, Team A will be penalised five yards at the previous spot followed by a 15-yard penalty against Team B, which includes an automatic first down. (2) Team B could decline the illegal-motion penalty and have the ball first and 10 after a 15-yard penalty from the out-of-bounds spot. (3) Team B could accept the five-yard penalty enforced at the out of bounds spot (Rule 6-3-13) followed by the 15-yard penalty against Team B. In all options, the clock starts on the snap (Rule 3-3-2-d-8). [Cited by 10-1-6-b]
- II. Ball carrier B17 at Team A's 11-yard line taunts pursuing A55 before scoring a touchdown on an intercepted pass. After B17 crosses the goal line, they are tackled by A55 five yards into the end zone. **RULING:** Unsportsmanlike conduct by B17 and A55. Both penalties are enforced. The penalty for B17's

live-ball foul is enforced at the A-11, and that for the dead-ball foul by A55 is enforced at the succeeding spot. First and 10 for Team B at the A-13. [Cited by 10-1-6-b]

- III. B1 fouls during a down before B2 intercepts a legal forward pass. After the ball is declared dead, A1 piles on. **RULING:** Team A retains the ball after the penalty against Team B is enforced. Team A then will be penalised for the dead-ball foul (Rule 5-2-3). [Cited by 10-1-6-b]
- IV. Team B is offside on the snap at its three-yard line (not a try) and Team A throws a legal forward pass into Team B's end zone. Team B intercepts and runs 101 yards to Team A's end zone, after which Team A clips. **RULING:** Repeat the down with Team A putting the ball in play at the Team B 16½-yard line. [Cited by 10-1-6-b]
- V. No fouls have occurred when Team B intercepts Team A's legal forward pass. On the runback, a Team B player clips. When the ball becomes dead, a Team A player piles on. **RULING:** Team B retains possession. Penalise Team B for its clipping foul, followed by a penalty for Team A's dead-ball foul. The yardages will cancel unless one enforcement spot was inside the 30-yard line and enforcement was toward that goal. [Cited by 10-1-6-b]
- VI. Team A punts and commits a touching violation. B1 clips during the runback of the punt, which is fumbled by B2. A1 recovers the fumble, and A2 fouls after the ball is dead. **RULING:** Team A has the first option because Team B fouled during the live ball. If Team A declines the penalty for Team B's foul, Team B will have the ball at the point of the violation, along with the option of accepting enforcement of the penalty for Team A's dead-ball foul. If Team A accepts the penalty for Team B's foul, the ball will belong to Team B after enforcement of the penalty for its live-ball foul followed by the penalty against Team A for the dead-ball foul. [Cited by 10-1-6-b]

Interval Fouls

ARTICLE 7. Penalties for fouls that occur between the end of the fourth period and the start of the extra period for overtime, between possession series during an extra period, and between extra periods are enforced from the appropriate yard line, the spot of the next possession series (*Exception:* Rule 10-2-5).

SECTION 2. Enforcement Procedures

Enforcement Spots

- ARTICLE 1. a. For many fouls, the enforcement spot is specified in the statement of the penalty. When the enforcement spot is not specified in the statement of the penalty, the enforcement spot is determined by the Three-and-One Principle (Rules 2-33 and 10-2-2-c).
- b. Possible enforcement spots are: the previous spot, the spot of the foul, the succeeding spot, the spot where the run ends, and – for scrimmage kicks only – the postscrimmage kick spot.

Determining the Enforcement Spot and the Basic Spot

ARTICLE 2. a. Dead-ball fouls. The enforcement spot for a foul committed when the ball is dead is the succeeding spot.

- b. Fouls by Team A behind the neutral zone. For the following fouls committed by Team A behind the neutral zone, the penalty is enforced at the previous spot: illegal use of hands, holding, illegal block, personal foul and unsportsmanlike conduct (*Exception:* If the foul occurs in Team A's end zone the penalty is a safety). However, see Rule 6-3-13 for kicking team fouls during scrimmage kick plays.
- c. The Three-and-One Principle (Rule 2-33) is as follows:
1. When the team in possession commits a foul *behind* the basic spot, the penalty is enforced at the spot of the foul.
 2. When the team in possession commits a foul *beyond* the basic spot, the penalty is enforced at the basic spot.
 3. When the team not in possession commits a foul *either behind or beyond* the basic spot, the penalty is enforced at the basic spot.

- d. The following are basic spots for the various categories of plays:
1. *Running plays.*
 - (a) *Previous spot*, when the related run ends behind the neutral zone.
 - (b) *End of the related run*, when the related run ends beyond the neutral zone.
 - (c) *End of the related run*, on running plays that have no neutral zone.
 2. *Running plays when the run ends in the end zone after change of team possession (not on a try).*
 - (a) *Succeeding spot*, when a foul occurs after a change of team possession in the end zone and the result of the play is a touchback.
 - (b) *Goal line*, when a foul occurs after a change of team possession in the field of play and the related run ends in the end zone (**Exception:** Rule 8-5-1-Exceptions).
 - (c) *Goal line*, when a foul occurs after a change of team possession in the end zone, the related run ends in the end zone, and the result of the play is not a touchback.
 3. *Pass plays.*
Previous spot, on legal forward pass plays.
 4. *Kick plays.*
 - (a) *Previous spot*, on legal kick plays unless the foul is governed by postscrimmage kick rules.
 - (b) *Postscrimmage kick spot*, if the foul is governed by postscrimmage kick rules.
- e. For Team B fouls during a legal forward pass play: Penalty enforcement for Team B for personal fouls and unsportsmanlike conduct is at the end of the last run when it ends beyond the neutral zone and there is no change of team possession during the down (Rule 7-3-12). (**A.R. 7-3-12:I**) (**A.R. 9-1-2:III**)

Approved Ruling 10-2-2

- I. A kickoff untouched by Team B goes out of bounds after illegal touching by Team A. Team A is flagged for holding or a personal foul during the kick. **RULING:** Team B has these options: It may snap the ball at the spot of the illegal touching; accept a five-, 10- or 15-yard penalty from the previous spot with Team A re-kicking; snap the ball five, 10 or 15 yards beyond the spot where the ball went out of bounds; or snap the ball 30 yards beyond Team A's restraining line.
- II. A Team A fumble or backward pass is loose in Team A's end zone, where A33 kicks or bats the ball. **RULING:** Penalty — Safety (Rule 8-5-1-b). [Cited by 9-4-1-c]
- III. A55 clips in Team B's end zone during a scrimmage kick that touches B44 in the field of play. **RULING:** Penalty — 15 yards. Enforcement is either at the previous spot (Team A retaining possession) or at the spot where the subsequent dead ball belongs to Team B.
- IV. Team A punts from its end zone and the ball is returned to the A-30. A23 clips B35 in Team A's end zone during the return. **RULING:** Penalty — 15 yards from the basic spot, which is the end of the run (the A-30). Team B's ball, first and 10.
- V. Team A punts from its end zone and the ball is returned to the A-30, where it is fumbled. A23 clips B35 in Team A's end zone during the fumble. The ball is recovered in the field of play. **RULING:** Penalty — 15 yards from the basic spot, which is the spot of the fumble, the A-30. Team B's ball, first and 10.
- VI. Team A's untouched punt from its end zone goes out of bounds at Team A's 40-yard line. A2, in their end zone, clips Team B before the ball is kicked. **RULING:** Penalty — Safety (Rule 9-1 penalty) or Team B may snap the ball at the Team A 25-yard line after enforcement of the penalty from where the ball went out of bounds. [Cited by 8-5-1-b]
- VII. Team A snaps at its one-yard line, and ball carrier A1 is downed on their five-yard line. Team B commits a personal foul in the end zone while the ball is in play. **RULING:** Penalty — 15 yards from the basic spot (five-yard line).
- VIII. During a punt, B1 holds A2 behind or beyond the neutral zone after the kick crosses the neutral zone and before it has touched Team B. **RULING:** Penalty — 10 yards. Subject to postscrimmage kick enforcement if Team B is next to snap the ball.
- IX. During A1's run, B25 fouls 10 yards beyond the neutral zone. After advancing 30 yards, A1 fumbles. B48 recovers and carries the ball across Team A's goal line. **RULING:** Penalise Team B from the basic spot, which is the spot of the fumble. Team A retains possession of the ball (Rule 5-2-3).

- X. First and 10 at the A-30. A1 advances the ball to the B-40, where they are downed. During the run, B1 clips on Team A's 45-yard line. **RULING:** Penalty — 15 yards at the B-40, which is the basic spot. First and 10 at the B-25.
- XI. First and 10 at the A-40. A1 advances to the B-40, where they fumble. During A1's run or during the fumble, B2 commits a personal foul at the 50-yard line. B1 recovers the fumble and returns the ball across Team A's goal line. **RULING:** Penalty — 15 yards from the basic spot, which is the end of the related run (Team B's 40-yard line) and first down for Team A.
- XII. During the return of a scrimmage kick, B40 blocks A80 in the back above the waist at the B-25. Team B's ball carrier is downed with the ball in their possession at Team B's 40-yard line. **RULING:** Team B foul, illegal block in the back. Penalty — 10 yards from the spot of the foul. Team B's ball, first and 10, from its 15-yard line. [Cited by 2-3-4-a, 9-3-5]
- XIII. Team B intercepts a legal forward pass, and the player who threw the pass is fouled during the return. **RULING:** Team B's ball, first down and 10, after enforcement of the penalty (Rules 2-27-5, 5-2-4 and 9-1).
- XIV. B1 intercepts a legal forward pass (not a try) deep in their end zone and is unable to get out of the end zone, where they are downed. During the run, B2 clips A1 (a) at the B-25; (b) at the B-14; (c) in the end zone. **RULING:** The basic spot is the B-20. (a) First and 10 at the B-10. (b) First and 10 at the B-7. (c) Safety. (Rules 8-5-1-b, 8-6-1 and 10-2-2-d-2-a).
- XV. B17 intercepts a legal forward pass (not a try) deep in their end zone and, as they attempt to run the ball out, A19 clips in the end zone. After the foul and before B17 leaves the end zone, B17 fumbles with A26 recovering on the two-yard line. **RULING:** Penalty — 15 yards from the goal line. Team B's ball, first and 10 at its 15-yard line (Rule 10-2-2-d-2-c).
- XVI. After a safety, Team A punts the ball at Team A's 20-yard line. The ball goes out of bounds untouched by Team B. **RULING:** Team B has the choice of the down being repeated at the A-15, or of putting the ball in play at the 50-yard line, or five yards beyond the inbounds spot.
- XVII. Second and 10 at the B-40. A4 takes the snap and scrambles to the right side of the field, going out of bounds at the B-12. During the play, A73 blocks B95 in the back at the B-24 to prevent them from making the tackle. **RULING:** Penalty — 10 yards enforced from the spot of the foul. Second and 4 on the B-34. [Cited by 2-3-4-a]

Postscrimmage Kick Enforcement

ARTICLE 3. a. Under postscrimmage kick enforcement rules, fouls by Team B that satisfy the conditions in paragraph b (below) are treated as if Team B had been in possession at the time the foul was committed, even though by Rule 2-4-1-b-3 team possession had not changed.

- b. Postscrimmage kick enforcement applies *only* to fouls by Team B during a scrimmage kick and *only* under the following conditions:
1. The kick is not during a try, a successful field goal, or in an extra period. (**A.R. 10-2-3:IV**)
 2. The ball crosses the neutral zone.
 3. The foul occurs before the end of the kick. (**A.R. 10-2-3:I, II and V**)
 4. Team B will next put the ball in play.

If these conditions are all met, the penalty is enforced according to the Three-and-One Principle. Team B is taken as the team in possession with the postscrimmage kick spot as the basic spot (Rule 10-2-2-c). See Rule 2-25-11 for the postscrimmage kick spot. (**A.R. 10-2-3:I-VII**)

Approved Ruling 10-2-3

- I. Either team fouls during a scrimmage kick after the ball has been touched beyond the neutral zone. The foul is beyond the neutral zone, and Team B will next put the ball in play. **RULING:** For fouls by Team B, penalty enforcement will be by the Three-and-One Principle with the postscrimmage kick spot as the basic spot (Rule 2-25-11). Team B's ball first and 10. For fouls by Team A, penalty enforcement is either from the previous spot or from the spot where the subsequent dead ball belongs to Team B (Rule 6-3-13). [Cited by 10-2-3-b, 10-2-3-b-3, 5-2-3-a]
- II. Team A's punt is blocked, crosses the neutral zone and is untouched by Team B beyond the neutral zone. It rebounds behind the neutral zone before Team B clips or holds. The ball is loose at the time of the foul. **RULING:** The foul is during the kick. If Team B is next to snap the ball, enforcement is according to postscrimmage kick rules. [Cited by 10-2-3-b, 10-2-3-b-3]

- III. Team A's punt is blocked behind the neutral zone before Team B clips or holds beyond the neutral zone. The ball never crosses the neutral zone during the play. **RULING:** Rule 10-2-3 applies only when a scrimmage kick crosses the neutral zone. Team A retains possession after the penalty is enforced at the previous spot. [Cited by 10-2-3-b]
- IV. Team A's successful field goal attempt is snapped from Team B's 30-yard line, and a Team B player commits a personal foul at the 20-yard line during the kick. **RULING:** Team A may void the score and have Team B penalised at the previous spot or accept the score and have Team B penalised on the ensuing kickoff (Rule 10-2-5-d). [Cited by 10-2-3-b, 10-2-3-b-1]
- V. Team A's untouched, unsuccessful field goal attempt is snapped from Team B's 30-yard line. Team B fouls at the 15-yard line during the kick. **RULING:** Team B's ball. The postscrimmage kick spot is at the 30-yard line and the enforcement is from the 15-yard line, the spot of the foul, with no possible repeat (Rules 2-25-11 and 8-4-2-b). [Cited by 10-2-3-b, 10-2-3-b-3, 2-25-11-c-1-a, 8-4-2-b-2]
- VI. Team A's punt crosses the neutral zone. During the kick, B79 holds A55 one yard beyond the neutral zone. B44 catches the kick at the B-25 and returns to the B-40 where they are tackled. **RULING:** B79's foul is covered by postscrimmage kick enforcement. The 10-yard penalty is enforced at the end of the kick, which is the B-25. First and 10 for Team B at the B-15. [Cited by 10-2-3-b]
- VII. Team A snaps the ball at the A-35 on fourth and 12. Just after the snap lineman B77 grabs guard A66 and pulls them to one side, allowing linebacker B43 to shoot the gap to try to block the kick. B44 catches the kick at the B-25 and returns to the B-40 where they are tackled. **RULING:** B77's holding foul is not covered by postscrimmage kick enforcement since it is before the kick. The 10-yard penalty is enforced at the previous spot. The penalty yardage alone does not give Team A a first down, but defensive holding includes an automatic first down. Therefore, Team A first and 10 at the A-45. [Cited by 10-2-3-b]

Fouls by Team A During Kicks

ARTICLE 4. Penalties for all fouls by the kicking team other than kick-catch interference (Rule 6-4) during a free kick play or a scrimmage kick play in which the ball crosses the neutral zone (except field goal attempts) are enforced by rule either at the previous spot as the basic spot (**Exception:** Penalty option is a safety for fouls in Team A's end zone) or at the spot where the subsequent dead ball belongs to Team B, at the option of Team B. (Rules 6-1-8 and 6-3-13)

Fouls During or After a Touchdown, Field Goal or Try

- ARTICLE 5. a. Fouls by the nonscoring team during a down that ends in a touchdown (not on the try).
- 1. Fifteen-yard penalties for personal fouls and for unsportsmanlike conduct fouls are enforced on the try, the succeeding kickoff or from the succeeding spot in extra periods at the option of the scoring team. If there is no kickoff, the accepted penalty is enforced on the try.
 - 2. Five- and 10-yard penalties are not enforced on the try or the succeeding kickoff. Such penalties are declined by rule unless enforcement is made possible by illegal touching of a kick during the down. (**A.R. 6-3-2:III-IV**)
- b. Penalties for defensive pass interference fouls on a try from on or inside the three-yard line are enforced one-half the distance to the goal line. If the try is successful, the penalty is declined by rule.
 - c. When a foul(s) occurs after a touchdown and before the ball is ready for play on the try or there was a live-ball foul treated as a dead-ball foul on the touchdown play, enforcement is on the try, the succeeding kickoff or from the succeeding spot in extra periods at the option of the offended team. (**A.R. 3-2-3:V**)
 - d. Penalties for live-ball fouls during field goal plays are administered by rule. When the field goal is successful, Team A shall have the option of cancelling the score and have the penalty enforced from the previous spot or declining the penalty(ies) and accepting the score. Team A may accept the score with penalties for personal fouls and unsportsmanlike conduct fouls enforced on the succeeding kickoff or from the succeeding spot in extra periods. Penalties for live-ball fouls treated as dead-ball fouls and those for dead-ball fouls after a field goal down are enforced at the succeeding spot.

- e. Penalties for fouls during and after a try down are administered under Rules 8-3-3, 8-3-4, 8-3-5 and 10-2-5-b. (**A.R. 3-2-3:VI-VII**)
- f. Distance penalties for fouls by either team may not extend a team's free kick restraining line behind its five-yard line. Penalties that would otherwise place the free kick restraining line behind a team's five-yard line are enforced from the next succeeding spot.

Approved Ruling 10-2-5

Fouls during a touchdown or field goal by Team A:

- I. During a touchdown run Team B clips in the field of play or the end zone. **RULING:** Team A has the option of the penalty being enforced on the try, the succeeding kickoff, or from the succeeding spot in extra periods (Rule 10-2-5-a-1).
- II. Team B commits a personal foul during a down when Team A scores a touchdown, and then Team A fouls after the score and before the ready-for-play signal on the try. **RULING:** Allow the score. Team A has the option of enforcement on the try, the succeeding kickoff, or from the succeeding spot in extra periods. Team B then also has the option of Team A being penalised on the try, the succeeding kickoff, or from the succeeding spot in extra periods. The yardage assessed on the live-ball/dead-ball penalties may cancel (Rule 10-2-5).
- III. Team B holds during Team A's touchdown run. Team A fouls after the score. **RULING:** Allow the score. The penalty for Team B's holding foul is declined by rule. Team B has the option of Team A being penalised on the try, the succeeding kickoff, or from the succeeding spot in extra periods (Rules 10-2-5-a-2 and 10-2-5-c).
- IV. A Team B player punches an opponent during or after Team A's touchdown run. Team B is offside on the successful try. **RULING:** Allow the touchdown. Disqualify the Team B player for fighting. Team A has the option of a penalty against Team B on the try, the succeeding kickoff, or from the succeeding spot in extra periods. After the successful try, Team A has the option of repeating the try with the offside penalty enforced on the try (Rules 10-2-5 and 8-3-3-b).
- V. Team B roughs the forward passer during a touchdown pass play. **RULING:** Allow the touchdown. Team A has the option of enforcement on the try, the succeeding kickoff, or from the succeeding spot in extra periods.
- VI. Team B is offside during a successful field goal down. **RULING:** Team A has the option to accept the penalty at the previous spot and repeat the down or to keep the points by declining the penalty.
- VII. Team B fouls on a successful field goal. **RULING:** Team A shall have the option of cancelling the score and have the penalty enforced from the previous spot or they may decline the penalty and accept the score. Team A may accept the score and have penalties for personal fouls and unsportsmanlike conduct enforced on the succeeding kickoff or from the succeeding spot in extra periods.

Fouls after a touchdown by Team A:

- VIII. Team A fouls after it scores a touchdown, and Team B fouls on the successful try. **RULING:** Allow the touchdown. Team B has the option of Team A being penalised on the try or the succeeding kickoff. Team A then has the option of Team B being penalised on a repeat of the try. Team B personal-foul penalties may be enforced on the subsequent kickoff or at the succeeding spot in extra periods. Yardages assessed on the succeeding kickoff may cancel.
- IX. Team A fouls after it scores a touchdown, and Team B fouls after a successful try. **RULING:** Allow the score. Team B has the option of Team A being penalised on the try, the succeeding kickoff, or from the succeeding spot in extra periods. For the foul after the try, Team B is penalised on the kickoff or at the succeeding spot in extra periods. [Cited by 8-3-3-b-1]

Fouls during a try with no change of team possession (this does not include live-ball fouls treated as dead-ball fouls or loss-of-down fouls):

- X. Team B fouls during a successful try. **RULING:** Repeat the down after enforcement, or the penalty is declined by rule. Penalties for personal fouls and unsportsmanlike conduct fouls may be enforced on the succeeding kickoff or at the succeeding spot in extra periods (Rule 8-3-3-b-1). [Cited by 8-3-1, 8-3-3-b-1]
- XI. Both Team A and Team B foul during a try. **RULING:** The try is repeated at the previous spot (Rule 8-3-3). [Cited by 8-3-3-a]
- XII. During a successful kick try from the three-yard line, Team B is offside. After the ball is dead, Team B commits a personal foul. **RULING:** If Team A elects to repeat the try, both penalties against Team B are enforced before the snap (Rule 10-1-6). If Team A declines the offside penalty and accepts the point, the penalty for Team B's dead-ball foul is then enforced on the kickoff or at the succeeding spot in extra periods (Rule 8-3-5). [Cited by 8-3-1]

XIII. During an unsuccessful kick try from the three-yard line, Team A commits an illegal motion foul. After the ball becomes dead, Team B fouls. **RULING:** Team B obviously will refuse the penalty for the Team A foul. Team B is penalised on the kickoff or at the succeeding spot in extra periods. [Cited by 8-3-1, 8-3-5]

Fouls after a try and before the succeeding kickoff:

XIV. Either team fouls. **RULING:** Enforce the penalty on the kickoff unless the try is the last down of the game. [Cited by 8-3-1, 8-3-5]

XV. Both teams foul before either penalty is completed. **RULING:** The fouls cancel. [Cited by 8-3-1, 8-3-5]

XVI. The penalty for Team B's foul after a successful try is accepted and will be enforced on the free kick; then:

1. Team A fouls after the try. **RULING:** Enforce the penalties in occurrence order on the kickoff or at the succeeding spot in extra periods.
2. Team B fouls after the try. **RULING:** Enforce both Team B penalties in occurrence order on the kickoff or at the succeeding spot in extra periods.
3. Both teams foul before either penalty is completed. **RULING:** These fouls cancel. The penalty for Team B's original foul is enforced on the kickoff or at the succeeding spot in extra periods.

Half-Distance Enforcement Procedures

ARTICLE 6. No distance penalty, including tries from on or inside the three-yard line, shall exceed half the distance from the enforcement spot to the offending team's goal line [**Exceptions:** (1)

Defensive pass interference on scrimmage downs, other than the try (Rules 7-3-8 and 10-2-5-b); and (2) On the try, defensive pass interference when the ball is snapped from outside the three-yard line].

Special Enforcement of Post-Possession Fouls

ARTICLE 7. In extra periods or during a try, fouls after a change of team possession have special enforcement.

- a. Penalties against either team are declined by rule. (**Exception:** Penalties for personal fouls, unsportsmanlike conduct fouls, dead-ball personal fouls and live-ball fouls treated as dead-ball fouls are enforced on the succeeding play.)
- b. A score by a team committing a foul during the down is cancelled. (**Exception:** Live-ball foul treated as a dead-ball foul.) (**A.R. 8-3-2:VII**)
- c. If both teams foul during the down and Team B had not fouled before the change of possession, the fouls cancel and the down is not repeated. On a try, the try is over. (**Exception:** Penalties for personal fouls, unsportsmanlike conduct fouls, dead-ball personal fouls and live-ball fouls treated as dead-ball fouls are enforced on the succeeding play. See Rule 8-3-5.) (**A.R. 8-3-4:III-IV**)

RULE 11

The Officials: Jurisdiction and Duties

SECTION 1. Jurisdiction

ARTICLE 1. # The officials' jurisdiction begins 60 minutes before the scheduled kickoff and ends when the referee declares the score final [S14].

SECTION 2. Responsibilities

ARTICLE 1. # The game shall be played under the supervision of four or more officials. The game may be played under the supervision of three officials under exceptional circumstances such as injury or delay in travel.

ARTICLE 2. # Officiating responsibilities and mechanics are specified in the current edition of the *Manual of Football Officiating*, published by IAFOA. Officials are responsible for knowing and applying the material in the Manual.

- a. The use of mechanics systems that span crews of 3 to crews of 8 is essential. The use of manuals that only specify a subset of the mechanics is prohibited in international competition.
- b. National federations and officiating bodies are encouraged to use standard mechanics in games played under their jurisdiction to facilitate their officials moving between domestic and international games
- c. From 2028, only officials who regularly use the latest approved mechanics will be considered for international tournaments. "Latest mechanics" will be the newest edition of the Manual of Football Officiating, or the previous edition for up to 12 months after its replacement.
- d. *Exceptions to b and c:* USA, Canada, Mexico and Japan.

RULE 12

Instant replay

SECTION 1. Scope of instant replay

Requesting a review

ARTICLE 1. a. At the suggestion of any official (including the video judge), the referee may request a review of any play within scope.

- b. A head coach may request a review by taking a team timeout before the ball is next legally put in play.
 - 1. After a review has been completed:
 - (a) If any on-field ruling is changed, the team is not charged with a timeout.
 - (b) If the on-field ruling is not changed, the timeout is charged and that team's privilege to request a review is revoked for the remainder of the game.
 - 2. If the play review being requested is not reviewable (see Rule 12-1-2), the timeout is charged but the team retains the privilege to request a review.
 - 3. A head coach may not request a review if their team's timeouts are exhausted or not available for that half or in that extra period.
 - 4. A request for a review shall be ignored when the privilege has been revoked or if the team's timeouts are exhausted or not available.
 - 5. A team may not challenge a ruling in which the game was stopped and a decision has already been made by the video judge. However, until the ball is ready for play, a team may challenge an aspect of the same play if that component of the play was not considered by the video judge as part of the initial review.
 - 6. If a team challenges a specific ruling, but a different ruling is changed, the team is not charged with a timeout and does not lose its privilege to challenge.

Approved Ruling 12-1-1

- I. A team requests a review of a particular aspect of the previous play. That aspect of the play is "out of shot" and cannot be seen on replay. (a) No other aspect of the previous play is changed. (b) Another aspect of the previous play is changed. **RULING:** (a) The team is charged with a timeout and loses the privilege to request a review. (b) The team is not charged with a timeout and retains the privilege to request a review. Rule 12-1-1-b has been designed to avoid a situation where a team could gain an advantage by repeatedly requesting reviews of aspects of plays that are not in view.
- II. A head coach requests a review when their team's timeouts are exhausted or not available. **RULING:** The request is ignored. This is not a breach of Rule 9-2-1-a-1-m since the request is permitted, even though it is not granted.

Reviewable plays

ARTICLE 2. a. A review can only be used for a play in which there is doubt about:

- 1. a score
- 2. the position of the ball in relation to the goal line
- 3. a change of team possession
- 4. a foul on the list of explicitly reviewable fouls (Rule 12-1-3) (a foul may be created or cancelled)
- 5. a disqualification

6. the status of the ball (e.g. live/dead, touched/untouched), including when and/or where the ball or a player is out of bounds or in an end zone, which player has possession of the ball, whether a pass is forward or backward, whether the ball was passed or fumbled or whether a forward pass is complete/incomplete
 7. whether the player who caught or recovered a fumble was the fumbler
 8. whether a fair catch signal was made or a player of the receiving team advanced after a fair catch signal (a foul may be created or cancelled)
 9. the location of a player with regard to substitutions, illegal passes (including intentional grounding), illegal kicks and handing (a foul may be created or cancelled)
 10. the location of the ball with respect to a first down
 11. the down number within a series of downs or before the next series
 12. clock status **and time remaining in a quarter**
 13. any obvious errors that may have a significant impact on the outcome of the game
- b. A review can equally be used to determine whether a reviewable action occurred or not.
- c. While undertaking a review of a particular aspect of a play, other reviewable aspects may come under consideration. A review can consider any reviewable aspect of the play for which the game was stopped.

Approved Ruling 12-1-2

- I. While reviewing a play to see whether the pass was complete or incomplete, the video judge spots a personal foul by A88. **RULING:** Foul by A88. Team B may accept or decline the penalty once the ruling of complete/incomplete has been finalised.
- II. During a review, the video judge sees clear evidence that the ball carrier was held and their forward progress stopped before the ball was fumbled. **RULING:** The play will be changed with the ball dead at the spot where the ball carrier's progress was stopped. *Unlike other codes of American football, a forward progress ruling (or absence of) is reviewable.*

Explicitly reviewable fouls

ARTICLE 3. The following plays are explicitly reviewable and the video judge may create a foul when there is no call by the on-field officials or cancel a foul called by an on-field official:

- a. A foul that normally carries a 15-yard penalty, including pass interference.
- b. Any foul on a play anytime after the two-minute warning in the 4th quarter or during an extra period.
- c. Player throwing a forward pass or making a forward handoff when the player's entire body and the ball is or has been beyond the neutral zone or after a change of team possession.
- d. Ball carrier beyond the neutral zone before ball kicked.
- e. Blocking by a Team A player before they are eligible to touch the ball on an onside kick.
- f. The number of players on the field for either team during a live ball or when there is a flag for illegal substitution
- g. Illegal touching of a forward pass by an originally eligible receiver who has gone out of bounds or touching of a forward pass by an originally ineligible player.
- h. A Team A player going out of bounds during a kick play and returning inbounds during the down, and whether such a player was blocked out of bounds.
- i. Player who is out of bounds touching a free kick that had not been touched inbounds.
- j. Forward pass that becomes illegal as a second forward pass after an on-field ruling of a backward pass is changed.

Approved Ruling 12-1-3

- i. Anytime after the two-minute warning in the 4th quarter or during an extra period, the video judge reviews a play and sees clear evidence of a false start prior to the snap. (a) A Team A player advanced the ball for 3 yards. (b) A Team A player fumbled the ball and it was recovered by Team B. **RULING:** In both (a) and (b), after the review the play will be changed. A 5-yard penalty will be enforced and Team A will have possession of the ball.

Injured players

ARTICLE 4. The video judge may declare an injury timeout if they observe an injured participant that the on-field officials have not (Rule 3-3-6).

Other rulings

- ARTICLE 5. a. If a forward passer is ruled down or out of bounds prior to throwing a pass and the video judge has **clear and obvious** video evidence that the ball was released prior to the dead ball ruling, replay can rule on the immediate continuing action. If the pass is caught by either team, they are awarded possession at that spot with no advance. If the pass is incomplete, the down counts.
- b. Fouls that carry 5-yard and 10-yard penalties are not enforced if the ruling is changed and they become dead-ball fouls.
 - c. Penalties for personal fouls and unsportsmanlike conduct fouls are always enforced, regardless of the outcome of a replay review.

SECTION 2. Procedures

Equipment and personnel

- ARTICLE 1. a. The video judge may use whatever video equipment is reasonably available. The sources of video to be used shall be determined by the video judge before the game. This may include body-worn cameras.
- b. When a replay is shown on a stadium screen, the on-field officials may observe it during a review and use clear evidence from it to change a decision. This may include situations when there is no video judge, but the referee has the ability to request a replay to be shown.
 - c. Review will not be used if there is no video judge AND the decision as to which plays to replay on the stadium screen is in the control of only one team.
 - d. If there is no video judge, but there is the capability to use video equipment near the field of play, the referee shall assume the duties of the video judge provided the following conditions apply:
 1. The equipment to be used in the review is located outside the limit lines on the sideline or end line and must be completely outside the team area. This is a separate secure location away from spectators and sideline personnel. Ideally, it will be in a tent or other shelter to protect it from rain and also direct sunlight on the display equipment.
 2. The sources of video to be used are determined by the referee before the game, and the referee agrees that the quality of the video obtainable from each source is sufficient for replay to be used effectively.
 3. The referee agrees that the size and resolution of the display equipment to be used at the sideline is sufficient for replay to be used effectively.
 4. National federations may implement a process by which game management must seek prior approval of sideline video equipment before it can be used in a competitive game.

Initiating review

- ARTICLE 2. a. A review can be initiated by stopping the game at any time before the ball is next legally put in play. This includes when there is a positive intention by any official to initiate a review, even if the whistle or signal to denote it comes after the ball is snapped or free kicked.
- b. A review can be initiated whenever an official believes that:
1. There is reasonable evidence to believe an error was made in the initial on-field ruling; and
 2. The play is reviewable; and
 3. The outcome of a review would have a direct, competitive impact on the game. Review shall not be used when there would be no competitive impact on the game, including when the running clock rule is in force (Rule 3-3-2).
- c. An official shall not initiate a review in a situation when it would give one team an advantage with respect to time (on either the game clock or play clock).
- d. There is no limit on the number of reviews initiated by the officials nor is there a time limit for a review. However, officials should have regard to the duration of the game and not instigate reviews that have little impact on the game.
- e. Disqualifications may be reviewed at any time since the impact normally includes the player's ability to play in the next game.

Criteria for reversing an on-field ruling

- ARTICLE 3. a. If there is **clear and obvious** evidence that a ruling on the field was incorrect or that something within the scope of the review procedure occurred and was missed by the on-field officials, the video judge will advise the on-field officials to change their ruling(s).
- b. If there is other evidence (e.g. not **clear and obvious**), the video judge shall inform the on-field officials of the evidence available and give them the opportunity to change their ruling(s) when that evidence is combined with evidence from their own observations. The video judge may not override the judgment of any of the on-field officials, but may advise them. The final determination of fact(s) shall remain with the on-field officials.
- c. An official (usually the referee) may act for any other on-field official who is unable to communicate with the video judge.
- d. When, in the judgment of the video judge, a foul should have been called, the referee may override that judgment if they believe the action as described to them would not have been ruled as a foul if it had been observed by an on-field official. The video judge is subject to the same officiating interpretations and philosophies as the on-field officials.

Information provision

- ARTICLE 4. a. The relevant official should repeat information provided to them by the video judge to ensure that both are satisfied that the on-field official has heard the information correctly.
- b. Normally, an on-field official (or the referee on their behalf) will ask the video judge to answer a specific question of fact.
- c. If a ruling is changed, the video judge shall provide the referee with all pertinent information as needed (next down, distance, yard line, position of the ball, clock status/adjustment) in order to resume play under the correct game conditions.
1. If the video judge does not know the precise information, an estimate can be used.
 2. If the game clock was running and was stopped solely for a review, it should be adjusted such that no more than 40 seconds can elapse since the end of the previous play.
 3. Anytime after the two-minute warning in the 2nd or 4th quarters, if the correct ruling would not have stopped the game clock, then the clock will be reset to the time the ball is declared dead by the video judge. The referee will subtract 10 seconds from the game clock and the

game clock will start on the referee's signal. Either team may use a team timeout to avoid the runoff.

4. If time expires in a half, and the clock would start on the referee's signal after review, there must be at least 3 seconds remaining when the ball should have been declared dead to restore time to the clock. With 2 seconds or 1 second remaining on the clock, the half is over unless Team A uses a remaining timeout. (This does not impact situations when the clock is stopped and will remain stopped until the snap such as an incomplete pass or a ball carrier out of bounds.)
 5. If the game clock expires at the end of any quarter, either during a down in which it should be stopped by rule through play when the ball becomes dead or after the down upon a request for an available team timeout, the video judge may restore time. In the fourth quarter, this only applies if the score differential is eight points or less (after a touchdown, all potential results of the try down must be considered).
- d. After a review is completed, the referee shall announce that:
1. the ruling on the field **is confirmed**, if the video evidence confirms the on-field ruling;
 2. the ruling on the field **stands**, if the video evidence is inconclusive;
 3. the ruling on the field **is changed**, why and what the impact of the ruling is, if the video evidence reveals an error occurred.

Summary of penalties

Officials' signals (see pages 166 - 168), the numbers refer to numbered illustrations; R, Rule; S, Section; A, Article; P, Page. Where a signal is marked *, the referee shall also give Signal 9.

Index		O	R	S	A	P
LOSS OF A DOWN						
1	Illegal scrimmage kick	31*	6	3	10	89
2	Illegally handing ball forward	35*	7	1	6	101
3	Planned loose ball play	19*	7	1	7	101
4	Intentionally throwing backward pass out of bounds	35*	7	2	1	101
5	Illegal forward pass by Team A	35*	7	3	2	103
6	Intentionally grounding forward pass	36*	7	3	2	103
7	Forward pass illegally touched by player out of bounds	16*	7	3	4	105
8	Forward pass illegally touched	16*	7	3	11	111
9	Illegally batting loose ball	31*	9	4	1	140
10	Illegally kicking ball	31*	9	4	4	141
LOSS OF FIVE YARDS						
1	Alteration of playing surface for an advantage	19	1	2	9	18
2	Improper numbering	23	1	4	2	21
3	Coin toss infractions	19	3	1	1	48
4	Illegal delay of game	21	3	4	2	65
5	Advancing a dead ball	21	3	4	2	65
6	Disconcerting offensive signals	21	3	4	2	65
7	Substitution rules infraction (live-ball)	22	3	5	2	68
8	Substitution rules infraction (dead-ball)	22	3	5	2	68
9	Delay of game (substitutions)	21	3	5	2	68
10	More than 11 players in the formation or during the play (Team A)	22	3	5	3	69
11	More than 11 players in the formation or during the play (Team B)	22	3	5	3	69
12	More than 11 players when the play clock expires	22	3	5	3	70
13	Putting ball in play before it is ready	19	4	1	4	75
14	Exceeding play clock count	21	4	1	5	76
15	Infraction of free kick formation	18, 19	6	1	2	82
16	Player out of bounds when ball free-kicked	19	6	1	2	83
17	Team A player illegally goes out of bounds (free kick)	19	6	1	11	85
18	Team A blocking during a free kick	19	6	1	12	86
19	Free kick out of bounds	19	6	2	1	86
20	Return kick	31	6	3	10	89
21	Illegal scrimmage kick (also loss of down)	31*	6	3	10	89
22	Marking spot of place kick	19	6	3	10	89
23	Team A player illegally goes out of bounds (scrimmage kick)	19	6	3	12	90
24	Defensive linemen in field goal formation	19	6	3	14	91
25	Taking more than two steps after a fair catch	21	6	5	2	94

Index		O	R	S	A	P
26	Illegal snap	19	7	1	1	96
27	Snapper's position and ball adjustment	19	7	1	3	97
28	Team A not within nine-yard marks after ready for play	19	7	1	3	97
29	Encroachment (offense) at snap	19	7	1	3	97
30	False start or simulating start of a play	19	7	1	3	97
31	Player out of bounds when ball is snapped	19	7	1	4	99
32	Offensive player illegally in motion at the snap	20	7	1	4	99
33	Illegal formation	19	7	1	4	99
34	Illegal formation due to numbering exception	19	7	1	4	99
35	Illegal shift	20	7	1	4	99
36	Interference with opponent or ball	18	7	1	5	100
37	Defensive player charging unabated toward a back	18	7	1	5	100
38	Abrupt defensive actions	21	7	1	5	100
39	Offside (defense)	18	7	1	5	100
40	Defensive player out of bounds at snap	19	7	1	5	100
41	Illegally handing ball forward (also loss of down)	35*	7	1	6	101
42	Planned loose ball play (also loss of down)	19*	7	1	7	101
43	Intentionally throwing backward pass out of bounds (also loss of down)	35*	7	2	1	101
44	Player on scrimmage line receiving snap	19	7	2	3	102
45	Illegal forward pass by Team A (also loss of down)	35*	7	3	2	103
46	Ineligible receiver downfield	37	7	3	10	110
47	Forward pass illegally touched (also loss of down)	16*	7	3	11	111
48	Running into the kicker or holder	30	9	1	16	129
49	Game administration interference (also 15 yards)	21,29	9	2	5	136
50	Interlocked interference or helping ball carrier	44	9	3	2	137
LOSS OF 10 YARDS						
1	Home team delay	21	3	4	1	64
2	Illegal block by fair catch signaller	40	6	5	4	95
3	Illegal use of hands or arms (offense)	42	9	3	3	138
4	Holding or obstruction (offense)	42	9	3	3	138
5	Locked hands	42	9	3	3	138
6	Illegal use of hands (defense) (first down)	42	9	3	4	139
7	Holding or obstruction (defense) (first down)	42	9	3	4	139
8	Illegal block in the back	43	9	3	5	140
9	Illegally batting loose ball (also loss of down)	31*	9	4	1	140
10	Illegally batting a backward pass	31	9	4	2	141
11	Batting a ball in possession by player in possession	31	9	4	3	141
12	Illegally kicking ball (also loss of down)	31*	9	4	4	141
LOSS OF 15 YARDS						
1	Marking ball	27	1	3	3	20
2	Numbers changed (also disqualification)	27	1	4	2	21
3	Improper colours	27	1	4	5	22
4	Illegal signal devices (also disqualification)	27, 47	1	4	10	26

Index		O	R	S	A	P
5	Eavesdropping (also disqualification)	27, 47	1	4	13	28
6	Team not ready to play at start of either half	21	3	4	1	64
7	Rapid substitution to opponent's disadvantage	27	3	5	2	68
8	Blocking a free kicker	40	6	1	9	85
9	Illegal wedge	27	6	1	10	85
10	Interference with opportunity to catch kick	33	6	4	1	92
11	Tackling or blocking fair catcher	38	6	5	5	95
12	Offensive pass interference	33	7	3	8	107
13	Defensive pass interference (first down)	33	7	3	8	108
14	Personal foul (first down)	38	9	1	0	121
15	Striking an opponent (first down)	38	9	1	2	121
16	Tripping (first down)	46	9	1	2	121
17	Targeting/forcible contact with crown of helmet (first down) (also disqualification)	24, 38, 47	9	1	3	122
18	Forcible contact to head/neck area of a defenseless player (first down) (also disqualification)	24, 38, 47	9	1	4	122
19	Clipping (first down)	39	9	1	5	123
20	Blocking below the waist (first down)	40	9	1	6	124
21	Late hit (first down)	38	9	1	7	126
22	Action out of bounds (first down)	38	9	1	7	126
23	Helmet/face mask fouls (first down)	38, 45	9	1	8	126
24	Roughing the passer (first down)	34	9	1	9	126
25	Chop blocking (first down)	41	9	1	10	127
26	Leverage/Leaping (first down)	38	9	1	11	128
27	Defensive restrictions	27	9	1	11	128
28	Fouling an opponent obviously out of the play (first down)	38	9	1	12	128
29	Hurdling (first down)	38	9	1	13	128
30	Illegal contact against the snapper (first down)	38	9	1	14	128
31	Horse-collar tackle (first down)	25, 38	9	1	15	128
32	Roughing the kicker or holder (first down)	30, 38	9	1	16	129
33	Simulating roughed or run into	27	9	1	16	129
34	Blocking a free kicker	40	9	1	16	129
35	Continued participation without a helmet (first down)	38	9	1	17	130
36	Illegal blind-side block (first down)	38	9	1	18	130
37	Unsportsmanlike conduct (first down)	27	9	2	1	131
38	Obscene or vulgar language	27	9	2	1	131
39	Persons illegally on the field	27	9	2	1	131
40	Provoking ill will	27	9	2	1	131
41	Player not returning ball to official	27	9	2	1	132
42	Persons leaving team area	27	9	2	1	132
43	Noise by persons subject to the rules	27	9	2	1	132
44	Concealing the ball	27	9	2	2	133
45	Simulated replacements or substitutions	27	9	2	2	133
46	Equipment to confuse opponents	27	9	2	2	133
47	Unusual action or verbiage to confuse opponents	27	9	2	2	133

Index		O	R	S	A	P
48	Simulating injury to confuse opponents or officials	27	9	2	2	133
49	More than one player with same number	27	9	2	2	134
50	Intentionally contacting an official (also disqualification)	27, 47	9	2	4	136
51	Game administration interference (also 5 yards)	27,29	9	2	5	136
52	Physical interference with an official	27	9	2	5	136
53	Fighting (first down) (also disqualification)	27, 38, 47	9	5	1	142
LOSS OF HALF DISTANCE TO GOAL LINE						
1	If distance penalty exceeds half the distance (except on defensive pass interference)	-	10	2	6	150
OFFENDED TEAM'S BALL AT SPOT OF FOUL						
1	Defensive pass interference (if less than a 15-yard penalty) (first down)	33	7	3	8	108
CHARGED TIMEOUT FOR A VIOLATION						
1	Illegal jersey numbers	27	1	4	5	23
2	Not wearing mandatory equipment	23	1	4	8	25
3	Wearing illegal equipment	23	1	4	8	25
4	Head coach's conference	21	3	3	4	59
5	Player presents as injured after ball is spotted	3	3	3	6	60
6	Head coach's review	21	12	1	1	152
VIOLATION						
1	Illegal touching of free kick by kicking team	16	6	1	3	84
2	Illegal touching of scrimmage kick by kicking team	16	6	3	2	87
3	Scrimmage-kick-batting exception	16	6	3	11	89
DISQUALIFICATION						
1	Prohibited signal devices	47	1	4	10	26
2	Eavesdropping	47	1	4	13	28
3	Flagrant fouls	47	9	1	1	121
4	Targeting/forcible contact with crown of helmet	38	9	1	3	122
5	Forcible contact to head/neck area of a defenseless player	38	9	1	4	122
6	Intentionally contacting an official	47	9	2	4	136
7	Two unsportsmanlike fouls	47	9	2	6	136
8	Fighting	47	9	5	1	142
AUTOMATIC FIRST DOWNS (DEFENSIVE FOULS)						
1	Defensive pass interference	33	7	3	8	108
2	Defensive pass interference (if less than a 15-yard penalty)	33	7	3	8	108
3	Personal foul	38	9	1	0	121
4	Striking an opponent	38	9	1	2	121
5	Tripping	46	9	1	2	121
6	Targeting/forcible contact with crown of helmet (also disqualification)	24, 38, 47	9	1	3	122
7	Forcible contact to head/neck area of a defenseless player (also disqualification)	24, 38, 47	9	1	4	122

Index		O	R	S	A	P
8	Clipping	39	9	1	5	123
9	Blocking below the waist	40	9	1	6	124
10	Late hit	38	9	1	7	126
11	Action out of bounds	38	9	1	7	126
12	Helmet/face mask fouls	38, 45	9	1	8	126
13	Roughing the passer	34	9	1	9	126
14	Chop blocking	41	9	1	10	127
15	Leverage/Leaping	38	9	1	11	128
16	Fouling an opponent obviously out of the play	38	9	1	12	128
17	Hurdling	38	9	1	13	128
18	Illegal contact against the snapper	38	9	1	14	128
19	Horse-collar tackle	25, 38	9	1	15	128
20	Roughing the kicker or holder	30, 38	9	1	16	129
21	Continued participation without a helmet	38	9	1	17	130
22	Illegal blind-side block	38	9	1	18	130
23	Unsportsmanlike conduct	27	9	2	1	131
24	Illegal use of hands (defense)	42	9	3	4	139
25	Holding or obstruction (defense)	42	9	3	4	139
26	Fighting (also disqualification)	27, 38, 47	9	5	1	142
REFEREE'S DISCRETION						
1	Penalty for unfair acts	27	9	2	3	135
WHEN IN QUESTION RULES						
1	Block below waist contact is below waist	-	2	3	2	30
2	Block in the back contact is at or below waist	-	2	3	4	30
3	Catch, recovery or interception not completed	-	2	4	3	31
4	Ball accidentally touched rather than batted	-	2	11	3	34
5	Ball not touched on kick or forward pass	-	2	11	4	34
6	Ball accidentally touched rather than kicked	-	2	16	1	36
7	Forward pass rather than backward pass	-	2	19	2	39
8	Forward pass and not fumble	-	2	19	2	39
9	It is a catchable forward pass	-	2	19	4	39
10	A player is defenseless	-	2	27	14	44
11	Stop clock for injured player	-	3	3	6	60
12	Forward progress stopped	-	4	1	3	73
13	Kick-catch interference	-	6	4	1	92
14	It is a catchable forward pass	-	7	3	8	107
15	Touchback rather than safety	-	8	5	1	117
16	Twisting, turning or pulling face mask (helmet opening)	-	9	1	8	126
17	Roughing kicker rather than running into	-	9	1	16	129

Summary of foul codes

Alphabetically by code:

Code	Foul
APS	Altering playing surface
ATR	Assisting the runner
BAT	Illegal batting
DEH	Holding, defense
DOD	Delay of game, defense
DOF	Offside, defense
DOG	Delay of game, offense
DPI-AB	Pass interference, defense, arm bar
DPI-CO	Pass interference, defense, cut off
DPI-GR	Pass interference, defense, grab and restrict
DPI-HT	Pass interference, defense, hook and turn
DPI-NPB	Pass interference, defense, not playing the ball
DPI-PTO	Pass interference, defense, playing through opponent
DSH	Delay of game, start of half
DSQ	Disqualification
ENC	Encroachment (offense)
FGT	Fighting
FST	False start
IBB	Illegal block in the back
IBK	Illegal block during kick
IBP	Illegal backward pass
IDP	Ineligible downfield on pass
IFD	Illegal formation, defense (3-on-1)
IFH	Illegal forward handing
IFK	Illegal free kick formation
IFP	Illegal forward pass
IKB	Illegally kicking ball
ILF	Illegal formation
ILM	Illegal motion
ING	Intentional grounding
IPN	Improper numbering
IPR	Illegal procedure
ISH	Illegal shift
ISP	Illegal snap
ITP	Illegal touching of a forward pass
IUH	Illegal use of hands
IWK	Illegal wedge on kickoff
KCI	Kick-catch interference
KIK	Illegal kick
KOB	Free kick out of bounds
OBK	Out of bounds during kick
OFH-GR	Holding, offense, grab and restrict
OFH-HR	Holding, offense, hook and restrict
OFH-TD	Holding, offense, takedown
OFK	Offside, free kick
OPI-BK	Pass interference, offense, blocking

Code	Foul
OPI-DT	Pass interference, offense, driving through
OPI-PK	Pass interference, offense, pick
OPI-PO	Pass interference, offense, pushing off
PF-BBW	Personal foul, blocking below the waist
PF-BOB	Personal foul, blocking out of bounds
PF-BSB	Personal foul, blind-side block
PF-CHB	Personal foul, chop block
PF-CLP	Personal foul, clipping
PF-FMM	Personal foul, face mask
PF-HCT	Personal foul, horse collar tackle
PF-HDR	Personal foul, hit on defenseless receiver
PF-HTF	Personal foul, hands to the face
PF-HUR	Personal foul, hurdling
PF-ICS	Personal foul, illegal contact with snapper
PF-LEA	Personal foul, leaping
PF-LHP	Personal foul, late hit/piling on
PF-LTO	Personal foul, late hit out of bounds
PF-OTH	Personal foul, other
PF-RFK	Personal foul, roughing free kicker
PF-RTH	Personal foul, roughing the holder
PF-RTK	Personal foul, roughing the kicker
PF-RTP	Personal foul, roughing the passer
PF-SKE	Personal foul, striking/kneeing/elbowing
PF-TGB	Personal foul, targeting (both Rules 9-1-3 and 4)
PF-TGC	Personal foul, targeting (crown of helmet)
PF-TGD	Personal foul, targeting (defenseless player)
PF-TRP	Personal foul, tripping
PF-UNR	Personal foul, unnecessary roughness
RNH	Running into the holder
RNK	Running into the kicker
SLI	Sideline interference, 5 yards
SLM	Sideline interference, 15 yards
SLW	Sideline interference, warning
SUB	Illegal substitution
UC-2PN	Unsportsmanlike conduct, two players with same number
UC-ABL	Unsportsmanlike conduct, abusive language
UC-BCH	Unsportsmanlike conduct, bench
UC-DBS	Unsportsmanlike conduct, dead ball shoving
UC-DEA	Unsportsmanlike conduct, delayed/excessive act
UC-FCO	Unsportsmanlike conduct, forcibly contacting an official
UC-RHT	Unsportsmanlike conduct, removal of helmet
UC-SBR	Unsportsmanlike conduct, simulating being roughed
UC-STB	Unsportsmanlike conduct, spiking/throwing ball
UC-TAU	Unsportsmanlike conduct, taunting/baiting
UC-UNS	Unsportsmanlike conduct, other
UFA	Unfair acts
UFT	Unfair tactics

Alphabetically by foul:

Code	Foul
APS	Altering playing surface
ATR	Assisting the runner
DOD	Delay of game, defense
DOG	Delay of game, offense
DSH	Delay of game, start of half
DSQ	Disqualification
ENC	Encroachment (offense)
FST	False start
FGT	Fighting
KOB	Free kick out of bounds
DEH	Holding, defense
OFH-GR	Holding, offense, grab and restrict
OFH-HR	Holding, offense, hook and restrict
OFH-TD	Holding, offense, takedown
IBP	Illegal backward pass
BAT	Illegal batting
IBK	Illegal block during kick
IBB	Illegal block in the back
ILF	Illegal formation
IFD	Illegal formation, defense (3-on-1)
IFH	Illegal forward handing
IFP	Illegal forward pass
IFK	Illegal free kick formation
KIK	Illegal kick
IKB	Illegally kicking ball
ILM	Illegal motion
IPR	Illegal procedure
ISH	Illegal shift
ISP	Illegal snap
SUB	Illegal substitution
ITP	Illegal touching of a forward pass
IUH	Illegal use of hands
IWK	Illegal wedge on kickoff
IPN	Improper numbering
IDP	Ineligible downfield on pass
ING	Intentional grounding
KCI	Kick-catch interference
DOF	Offside, defense
OFK	Offside, free kick
OBK	Out of bounds during kick
DPI-AB	Pass interference, defense, arm bar
DPI-CO	Pass interference, defense, cut off
DPI-GR	Pass interference, defense, grab and restrict
DPI-HT	Pass interference, defense, hook and turn
DPI-NPB	Pass interference, defense, not playing the ball
DPI-PTO	Pass interference, defense, playing through opponent
OPI-BK	Pass interference, offense, blocking

Code	Foul
OPI-DT	Pass interference, offense, driving through
OPI-PK	Pass interference, offense, pick
OPI-PO	Pass interference, offense, pushing off
PF-BSB	Personal foul, blind-side block
PF-BBW	Personal foul, blocking below the waist
PF-BOB	Personal foul, blocking out of bounds
PF-CHB	Personal foul, chop block
PF-CLP	Personal foul, clipping
PF-FMM	Personal foul, face mask
PF-HTF	Personal foul, hands to the face
PF-HDR	Personal foul, hit on defenseless receiver
PF-HCT	Personal foul, horse collar tackle
PF-HUR	Personal foul, hurdling
PF-ICS	Personal foul, illegal contact with snapper
PF-LTO	Personal foul, late hit out of bounds
PF-LHP	Personal foul, late hit/piling on
PF-LEA	Personal foul, leaping
PF-OTH	Personal foul, other
PF-RFK	Personal foul, roughing free kicker
PF-RTH	Personal foul, roughing the holder
PF-RTK	Personal foul, roughing the kicker
PF-RTP	Personal foul, roughing the passer
PF-SKE	Personal foul, striking/kneeing/elbowing
PF-TGB	Personal foul, targeting (both Rules 9-1-3 and 4)
PF-TGC	Personal foul, targeting (crown of helmet)
PF-TGD	Personal foul, targeting (defenseless player)
PF-TRP	Personal foul, tripping
PF-UNR	Personal foul, unnecessary roughness
RNH	Running into the holder
RNK	Running into the kicker
SLI	Sideline interference, 5 yards
SLM	Sideline interference, 15 yards
SLW	Sideline interference, warning
UFA	Unfair acts
UFT	Unfair tactics
UC-ABL	Unsportsmanlike conduct, abusive language
UC-BCH	Unsportsmanlike conduct, bench
UC-DBS	Unsportsmanlike conduct, dead ball shoving
UC-DEA	Unsportsmanlike conduct, delayed/excessive act
UC-FCO	Unsportsmanlike conduct, forcibly contacting an official
UC-UNS	Unsportsmanlike conduct, other
UC-RHT	Unsportsmanlike conduct, removal of helmet
UC-SBR	Unsportsmanlike conduct, simulating being roughed
UC-STB	Unsportsmanlike conduct, spiking/throwing ball
UC-TAU	Unsportsmanlike conduct, taunting/baiting
UC-2PN	Unsportsmanlike conduct, two players with same number

Code PF-BTH has been deprecated (as of 2026) in favour of the three PF-TG* codes.

Officials' Signals

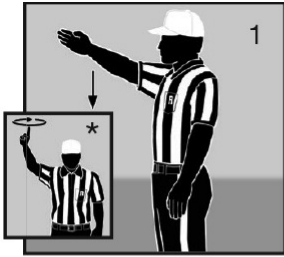

Ready for play
*Untimed down

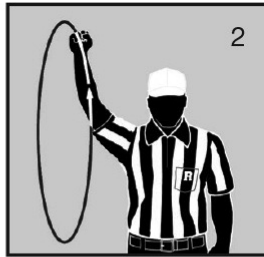

Start the clock



Stop the clock



TV/radio timeout



Touchdown
Field Goal

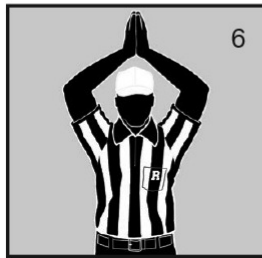

Safety



Dead-ball foul/
touchback
(move side to side)

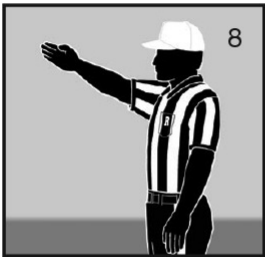

First down

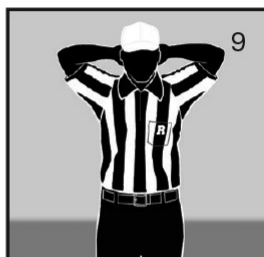

Loss of down

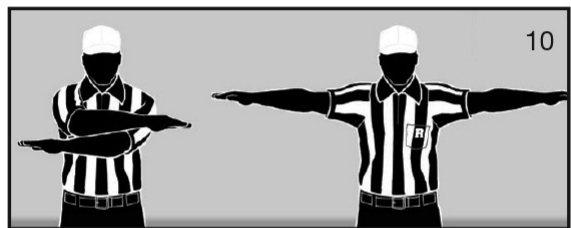

Incomplete pass/unsuccessful try or
field goal/penalty declined/
coin toss option deferred



Legal touching

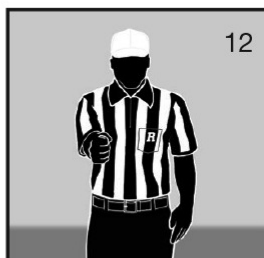

Inadvertent whistle

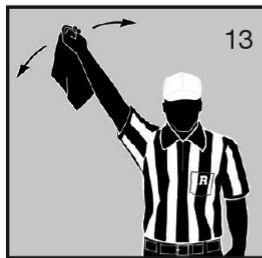

Disregard flag

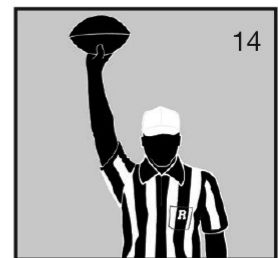

End of period

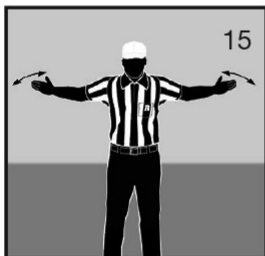

Sideline warning

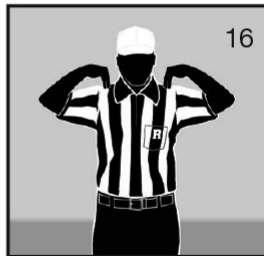

Illegal touching



Uncatchable pass

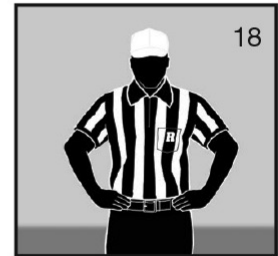

Offside B/Offside A
or B on kickoff

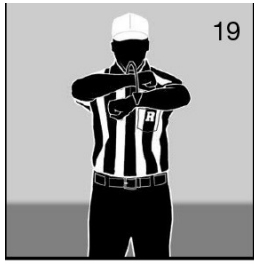

19
False start/
Encroachment A
Illegal formation

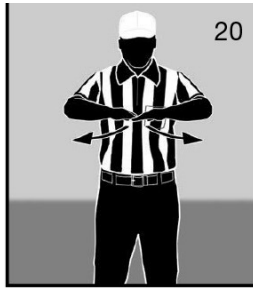

20
Illegal motion (1 hand)
Illegal shift (2 hands)



21
Delay of game



22
Substitution
infraction

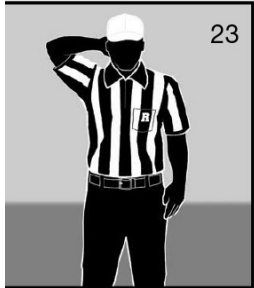

23
Equipment violation

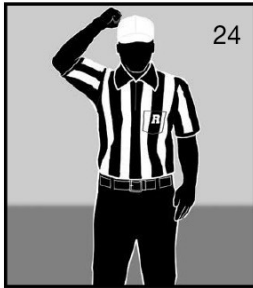

24
Targeting

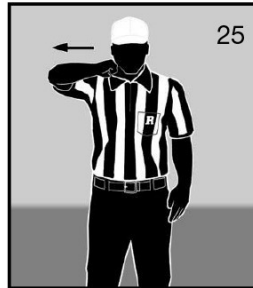

25
Horse-collar

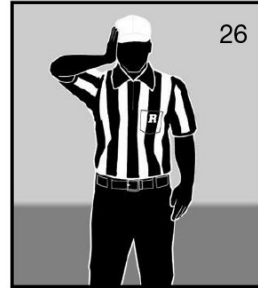

26
Hands to the face

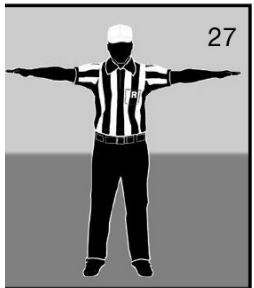

27
Unsportsmanlike
conduct

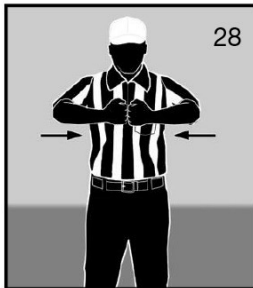

28
Illegal blindside
block

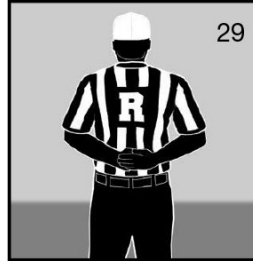

29
Sideline interference
Note: Face press box
when giving signal.

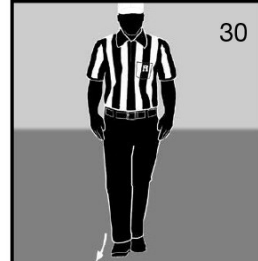

30
Running into or
roughing the kicker
or holder

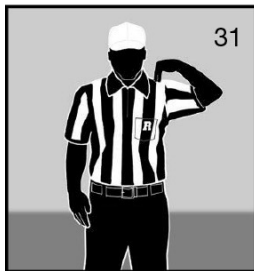

31
Illegal batting/kicking
(for illegal kicking, follow
with a point toward foot)



32
Illegal fair catch

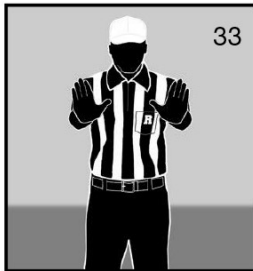

33
Pass interference
Kick-catching
interference

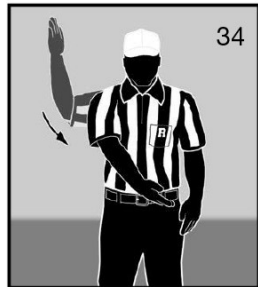

34
Roughing the passer

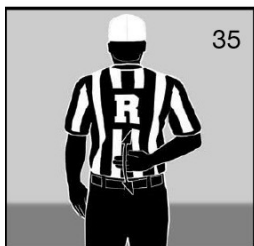

35
Illegal pass
Illegal forward handing
Note: Face press box
when giving signal.

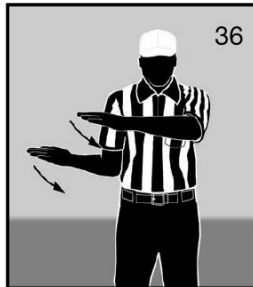

36
Intentional grounding

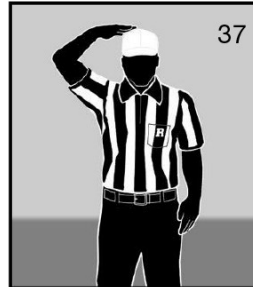

37
Ineligible receiver
downfield

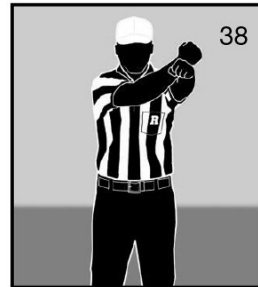

38
Personal foul

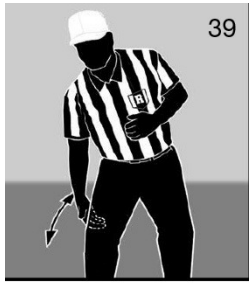

Clipping

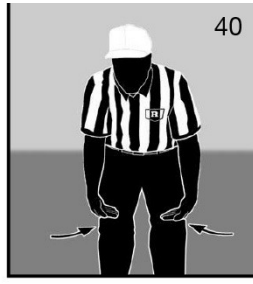

Block below the waist
Illegal block

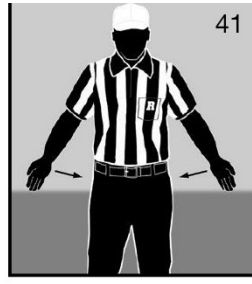

Chop block

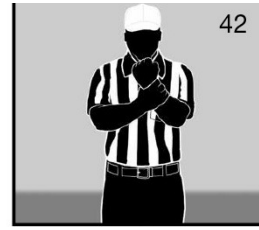

Holding
Obstructing
Illegal use of the hands or arms

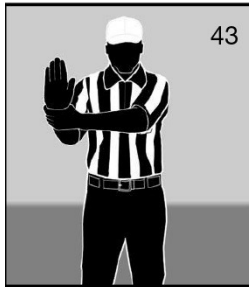

Illegal block
in the back

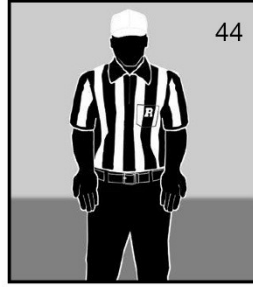

Helping the runner
Interlocked
interference

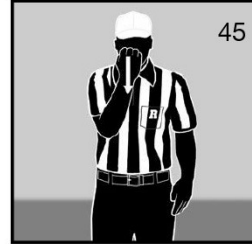

Grasping of
face mask or
helmet opening

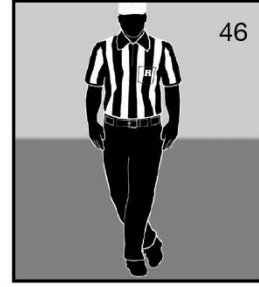

Tripping

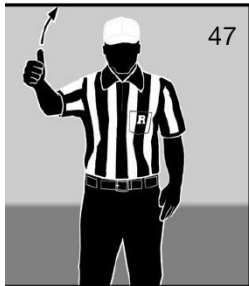

Disqualification

Appendix A

Guidelines for Game Officials for Serious On-Field Player Injuries

1. Players and coaches must go to and remain in the bench area. Direct players and coaches accordingly. Always ensure adequate lines of vision between the medical staffs and available emergency personnel.
2. Attempt to keep players a significant distance away from the seriously injured player or players.
3. Do not allow a player to roll an injured player over.
4. Do not allow players to assist a teammate who is lying on the field; i.e., removing the helmet or chin strap, or attempting to assist breathing by elevating the waist.
5. Do not allow players to pull an injured teammate or opponent from a pile.
6. Once the medical staff begins to assist an injured player, all members of the officiating crew should control the total playing field environment and team personnel, and allow the medical staff to perform services without interruption or interference.
7. Players and coaches should be appropriately controlled to avoid dictating medical services to the athletic trainers or team physicians, or taking up their time to perform such service.

Note: Officials should have a reasonable knowledge of the location of emergency personnel equipment at all stadiums.

(The Rules Committee expresses its appreciation to the National Football League for development of these guidelines.)

Appendix B

Guidelines for Game Officials and Game Management To Use Regarding Lightning

The purpose of this appendix is to provide information to those responsible for making decisions about suspending and restarting games based on the presence of lightning.

Lightning is the most consistent and significant weather hazard that may affect outdoor sport. While the probability of being struck by lightning is low, the odds are significantly greater when a storm is in the area and proper safety precautions are not followed.

Education and prevention are the keys to lightning safety. Authorities should begin prevention long before any athletics event or practice by being proactive and having a lightning safety plan in place. The following steps are recommended to mitigate the lightning hazard:

1. Designate a person to monitor threatening weather and to make the decision to remove a team or individuals from an athletics site or event. A lightning safety plan should include planned instructions for participants and spectators, designation of warning and all-clear signals, proper signs, and designation of safer places for shelter from the lightning.
2. Monitor local weather reports each day before any practice or event. Be diligently aware of potential thunderstorms that may form during scheduled athletics events or practices. Weather information can be found through various means via local television news coverage, the Internet, [smartphone apps](#), or national weather services.
3. Be informed of severe weather warnings, and the warning signs of developing thunderstorms in the area, such as high winds or darkening skies.
4. Know where the closest safer structure or location is to the field or playing area, and know how long it takes to get to that location. A safer structure or location is defined as:
 - a. Any building normally occupied or frequently used by people, i.e., a building with plumbing and/or electrical wiring that acts to electrically ground the structure. Avoid using the shower or plumbing facilities and having contact with electrical appliances during a thunderstorm.
 - b. In the absence of a sturdy, frequently inhabited building, any vehicle with a hard metal roof (neither a convertible, nor a golf cart) with the windows shut provides a measure of safety. The hard metal frame and roof, not the rubber tyres, are what protects occupants by dissipating lightning current around the vehicle and not through the occupants. It is important not to touch the metal framework of the vehicle.
5. Lightning awareness should be heightened at the first flash of lightning, clap of thunder, and/or other criteria such as increasing winds or darkening skies, no matter how far away. These types of activities should be treated as a warning or wake-up call to event personnel. Lightning safety experts suggest that if you hear thunder, begin preparation for evacuation; if you see lightning, consider suspending activities and heading for your designated safer locations.

The following specific lightning safety guidelines have been developed with the assistance of lightning safety experts. Design your lightning safety plan to consider local safety needs, weather patterns and thunderstorm types.

- a. As a minimum, lightning safety experts strongly recommend that by the time the monitor observes 30 seconds between seeing the lightning flash and hearing its associated thunder, all individuals should have left the athletics site and reached a safer structure or location.

- b. Please note that thunder may be hard to hear if there is an athletics event going on, particularly in stadiums with large crowds. Implement your lightning safety plan accordingly.
- c. The existence of blue sky and the absence of rain are not guarantees that lightning will not strike. At least 10 percent of lightning occurs when there is no rainfall and when blue sky is often visible somewhere in the sky, especially with summer thunderstorms. Lightning can, and does, strike as far as 10 (or more) miles away from the rain shaft.
- d. Avoid using landline telephones, except in emergency situations. People have been killed while using a landline telephone during a thunderstorm. Cellular or cordless phones are safe alternatives to a landline phone, particularly if the person and the antenna are located within a safer structure or location, and if all other precautions are followed.
- e. To resume athletics activities, lightning safety experts recommend waiting 30 minutes after both the last sound of thunder and last flash of lightning. If lightning is seen without hearing thunder, lightning may be out of range and therefore less likely to be a significant threat. At night, be aware that lightning can be visible at a much greater distance than during the day as clouds are being lit from the inside by lightning. This greater distance may mean that the lightning is no longer a significant threat. At night, use both the sound of thunder and seeing the lightning channel itself to decide on resetting the 30-minute return-to-play clock before resuming outdoor athletics activities.
- f. People who have been struck by lightning do not carry an electrical charge. Therefore, cardiopulmonary resuscitation (CPR) is safe for the responder. If possible, an injured person should be moved to a safer location before starting CPR. Lightning-strike victims who show signs of cardiac or respiratory arrest need prompt emergency help. [Call for emergency assistance](#). Prompt, aggressive CPR has been highly effective for the survival of victims of lightning strikes.

Automatic external defibrillators (AEDs) have become a common, safe and effective means of reviving persons in cardiac arrest. Planned access to early defibrillation should be part of your emergency plan. However, CPR should never be delayed while searching for an AED.

Note: Weather watchers, real-time weather forecasts and commercial weatherwarning devices are all tools that can be used to aid in decision-making regarding stoppage of play, evacuation and return to play.

Dangerous Locations

Outside locations increase the risk of being struck by lightning when thunderstorms are in the area. Small covered shelters are not safe from lightning. Dugouts, rain shelters, golf shelters and picnic shelters, even if they are properly grounded for structural safety, are usually not properly grounded from the effects of lightning and side flashes to people. They are usually very unsafe and may actually increase the risk of lightning injury. Other dangerous locations include areas connected to, or near, light poles, towers and fences that can carry a nearby strike to people. Also dangerous is any location that makes the person the highest point in the area.

Adapted by IFAF from NCAA guidelines.

Appendix C

Concussions

A concussion is a brain injury that may be caused by a blow to the head, face, neck or elsewhere on the body with an "impulsive" force transmitted to the head. Concussions can occur without loss of consciousness or other obvious signs. [Signs and symptoms may present immediately or evolve over minutes or hours.](#) A repeat concussion that occurs before the brain recovers from the previous one (hours, days or weeks) can slow recovery or increase the likelihood of having long-term problems. In rare cases, repeat concussions can result in brain swelling, permanent brain damage and even death.

Game officials are often in the best position to observe players after they have had a blow to the head or body, and may be the first to notice the behaviours that indicate a concussion may be present.

While the following is primarily focused on players, any participant can suffer a concussion and must be removed from the field of play.

Clear indicators of concussion include when a player:

- appears dazed or stunned; has a blank or glassy-eyed stare
- appears confused or incoherent
- cannot remember things that happened (amnesia)
- seems slow to answer questions or follow directions, or is easily distracted
- shakes head, grabs or clutches head
- stumbles, has to be physically supported by teammates or loses balance
- moves clumsily or awkwardly
- shows behaviour or personality changes (e.g. becomes more emotional or irritable)

Other signs include:

- seizure or convulsion
- loss of consciousness
- disoriented; not aware of where they are
- lying motionless on the ground or very slow to get up off the ground
- blood or clear fluid leaking from the nose or ears

[A player may be suspected of having sustained a concussion if they report one or more of the following symptoms:](#)

- headache
- dizziness
- feeling dazed
- loss or blurring of vision, double vision, or seeing stars or flashing lights
- being more emotional or irritable than normal
- ringing in the ears or sudden deafness
- sleepiness or fatigue
- stomach ache or pain, nausea or vomiting
- poor coordination
- slurred speech
- poor concentration

IF A CONCUSSION IS SUSPECTED:

1. Remove the participant from play. Look for the signs and symptoms of concussion if the participant has experienced a blow to the head. Do not allow the participant to just "shake it off". Each individual will respond to concussions differently.
2. Ensure that the participant is evaluated right away by an appropriate healthcare practitioner. Do not try to judge the severity of the injury yourself. Call an injury timeout to ensure that the participant is evaluated by one of the medical personnel present.
3. Allow the participant to return to play only with permission from medical personnel. Allow medical staff to rely on their clinical skills and protocols in evaluating the participant to establish the appropriate management.
4. Unless a healthcare practitioner has evaluated the participant and has cleared them from concussion, they may not return to play on the same day. Participating without being cleared is flagrant unsportsmanlike conduct, [requiring disqualification](#).
5. Further recovery should follow the concussion management protocol set out by your national federation.

Appendix D

Field Diagrams

Goal post detail

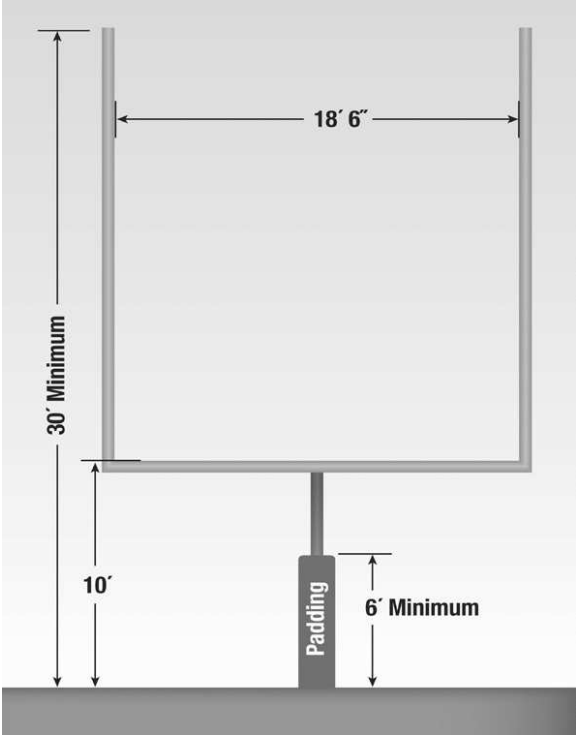

Pylon detail

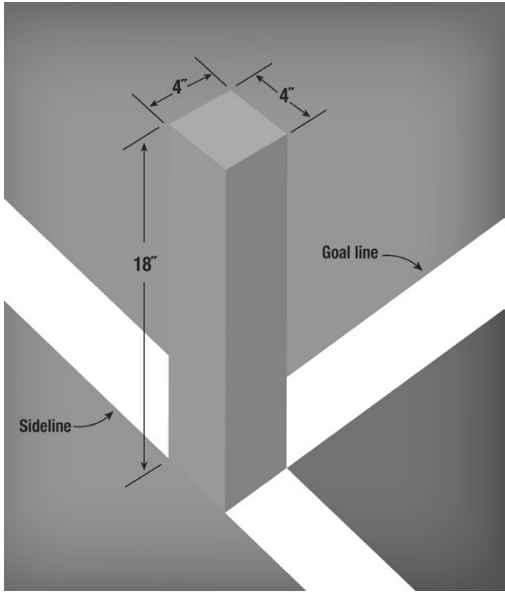

Yard line detail

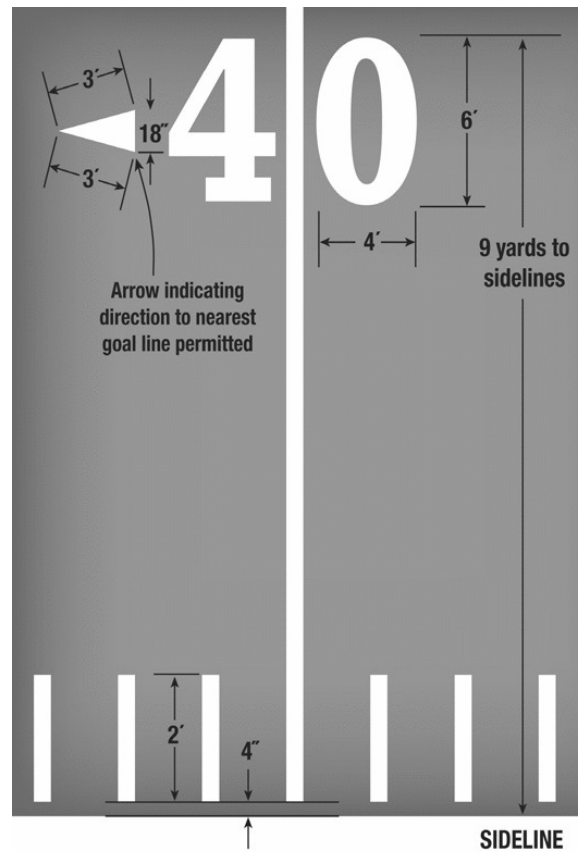

End zone detail

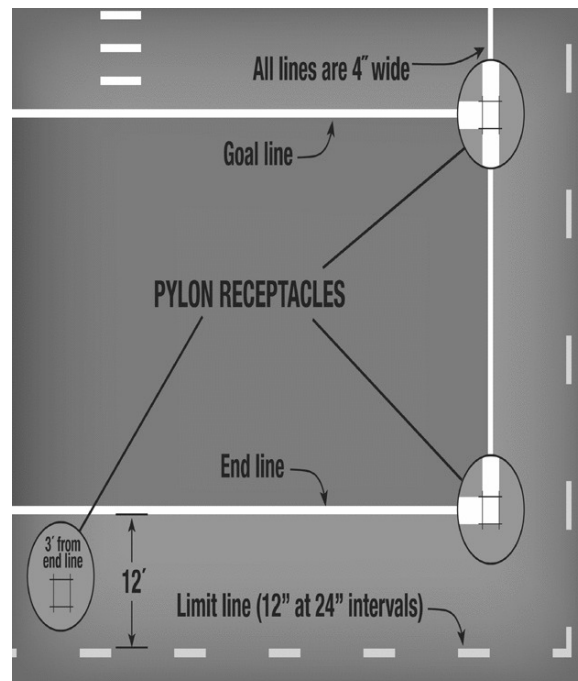

Important note: Although the diagram above shows the limit lines at 12', IFAF limit lines should normally be 18' from the sidelines/end lines (Rule 1-2-3-a).

Field diagram

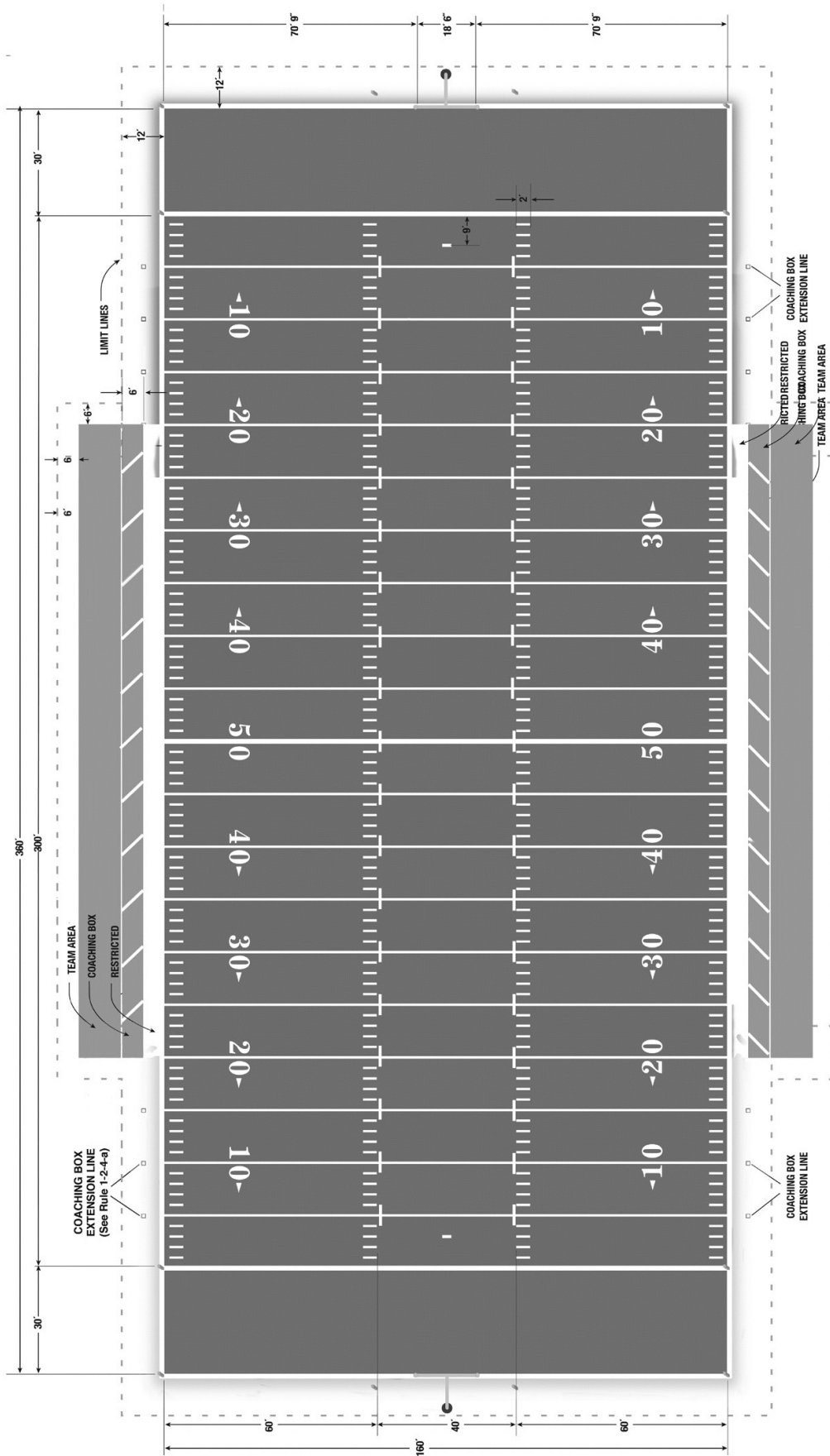

Free-blocking zone and tackle box

FREE-BLOCKING ZONE

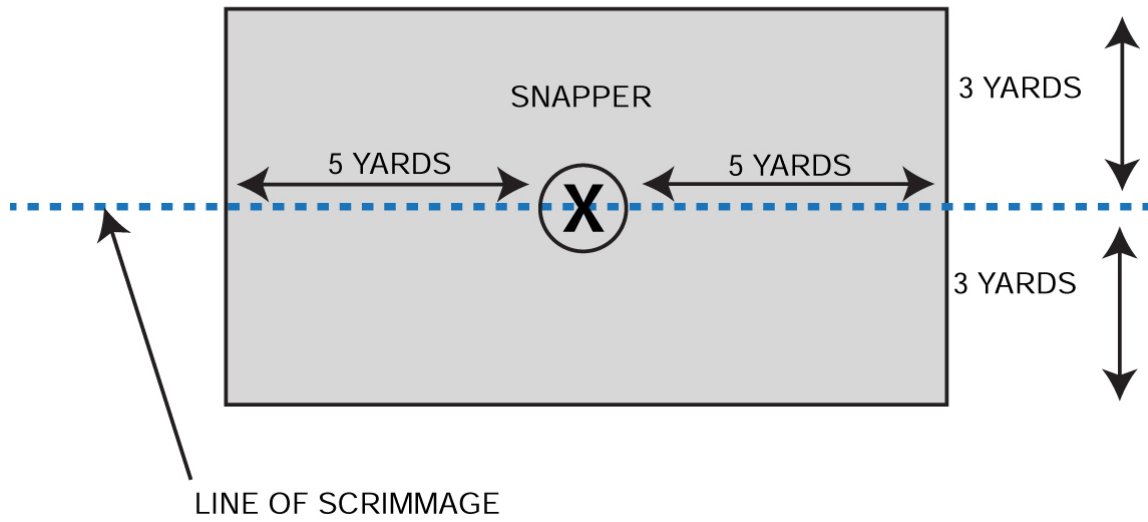

TACKLE BOX

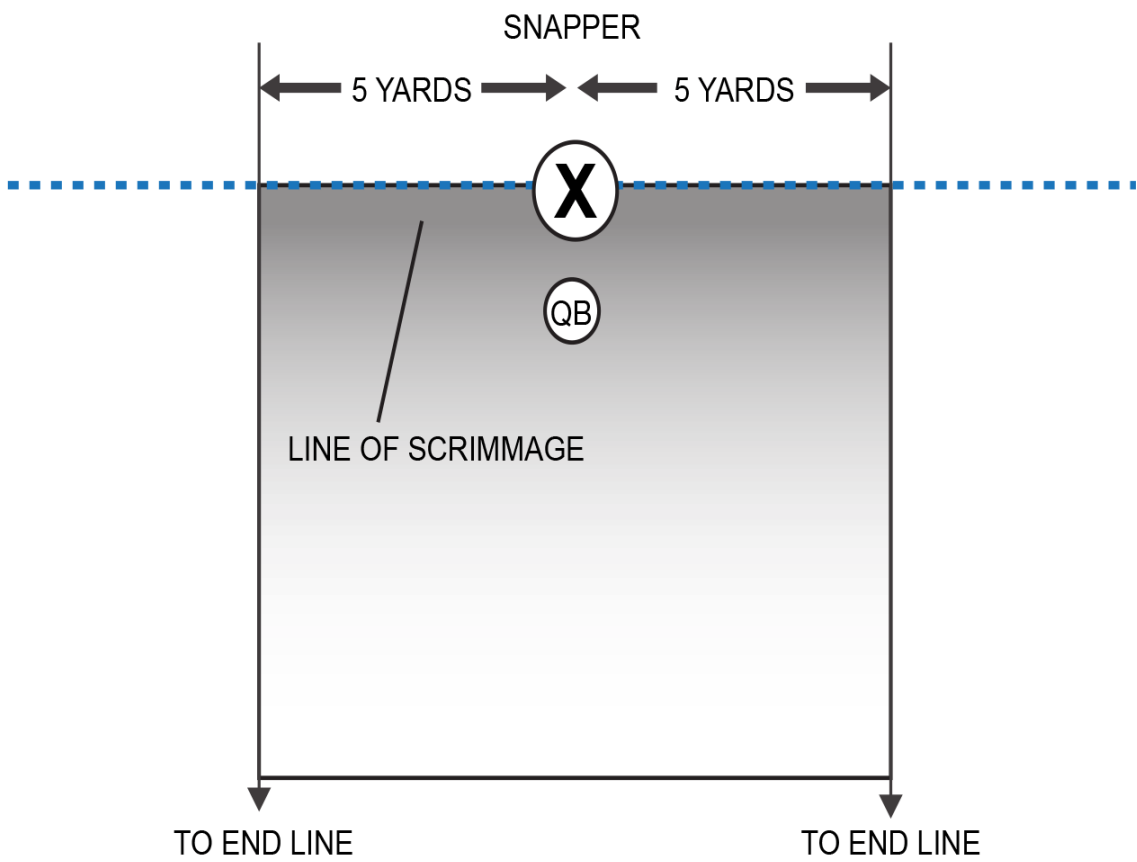

Pregame procedures (L-shaped configuration)

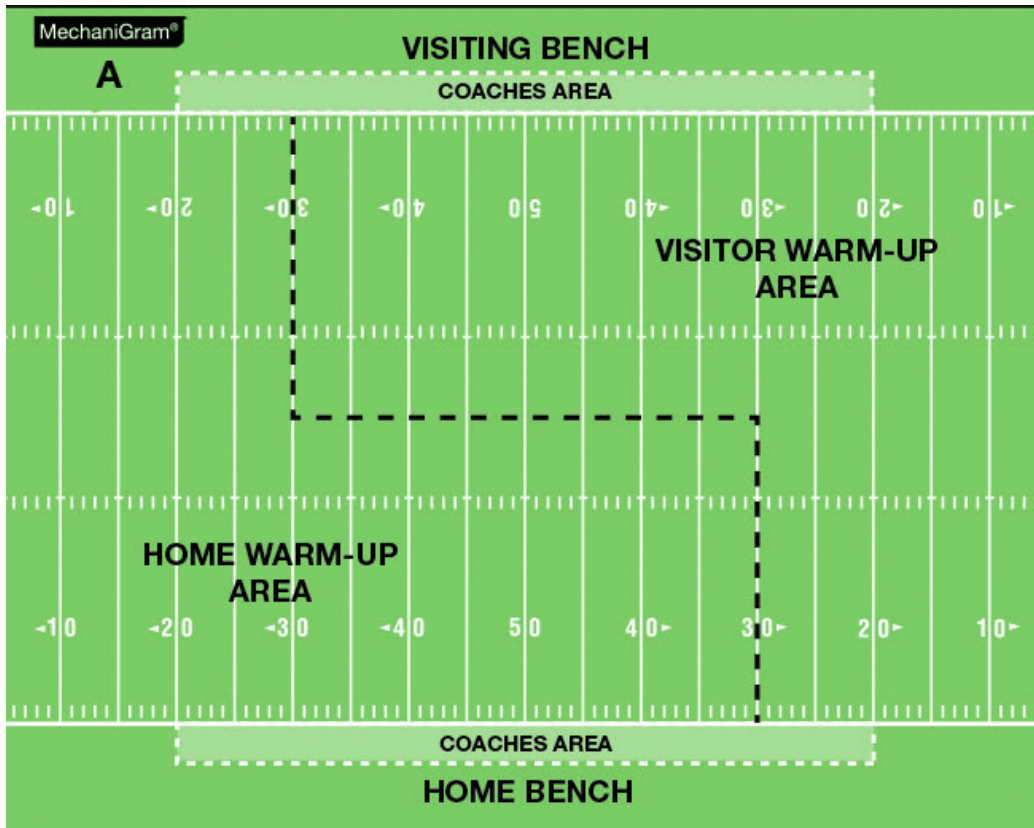

Pregame procedures (buffer zone configuration)

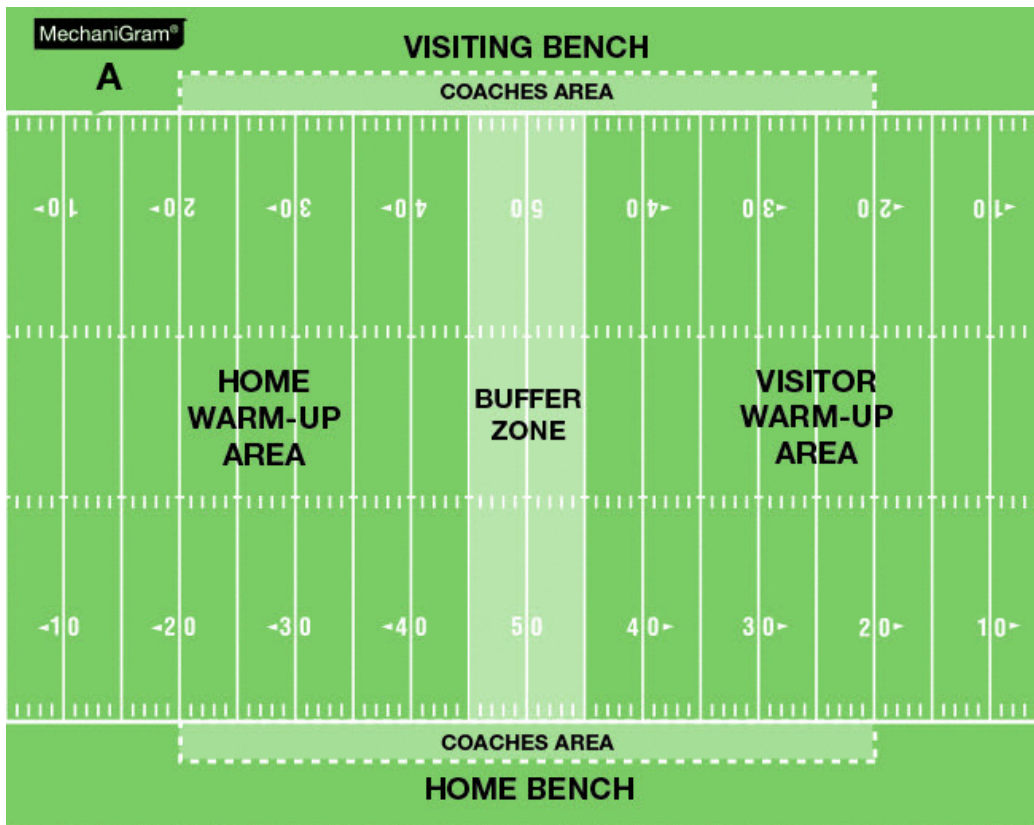

Notes for the groundsperson

These notes accompany the field diagram as a summary of requirements for the marking of the field. For full details see Rule 1-2.

1. There is no such thing as a metric American football field. All measurements are in yards, feet and inches.
1 yard = 3 feet = 36 inches = 91.44cm
1 foot = 12 inches = 30.48cm
1 inch = 2.54cm
1 yard = 36 inches (91.44cm), but may be shortened to no less than 34.12 inches (86.67cm) only if necessary to fit a 100-yard field of play plus two 10-yard end zones within the available playing surface. If the length of the field is reduced in this way, all other field dimensions and markings stated in the rules must be reduced commensurately (except for the length of the 2ft short yard-line extensions and the 4in width of lines).
2. A full sized field is 360ft long and 160ft wide, consisting of two 10yd end zones and twenty 5yd grid segments.
3. Note that the width of the field is significantly less than for sports such as soccer, rugby or hockey and that it cannot be varied (except where reduced commensurately by use of IFAF yards).
4. Measurements are made from the inside edge of the boundary lines. The entire width of the goal line shall be in the end zone.
5. Yard lines across the field at 5yd intervals between the goal lines (i.e. NOT in the end zones) are essential: they are relied upon for accurate measurement of the distance the ball is advanced. These lines should stop 4in away from each sideline. Only the goal lines and end lines touch the sidelines.
6. The short yard-line extensions (sometimes inaccurately called "hash marks") are 60ft from each sideline. (N.B. Some field diagrams show these to be 53ft 4in or 70ft 9in from the sidelines – those are not correct for IFAF games.) Each short yard-line extension should be 2ft long (i.e. from a point 60ft from the sideline to a point 58ft from the sideline) on each side of the field. The short yard-line extensions do NOT extend into the end zones.
7. Similar 2ft long lines must be marked starting 4in inside each sideline (between the goal lines). These should line up with the ones in the middle of the field to give a series of consistent reference points for aligning the ball. Similarly to the yard lines, these lines should stop 4in away from each sideline.
8. There must either be numbers or marks 27ft from each sideline on every 10yd line (but not the 5yd lines). If numbers then it is the *top* of each number that is 27ft from the sideline. The proper size of the numbers is 6ft x 4ft but they can be smaller if necessary. If not numbers, a 1ft long mark should be made 27ft in from each sideline on each 10yd line.
9. There should be two (adjacent) boxes drawn outside each sideline, stretching from a point 20yds from each goal line. Stretching from 6ft to 12ft outside the sideline is the *coaching box*. Stretching from 12ft as far as there is room for it is the *team area*. These are the areas in which coaches and substitutes must stay during play.
10. Outside the sidelines and end lines, there should be a set of dashed limit lines drawn, if possible, 18ft away from the field of play. This marks the boundary of the field, and all spectators, photographers, cheerleaders, etc. should be outside it.
11. If spectators are not confined to a particular area (e.g. the stands), then for reasons of safety there should be a rope or something similar that keeps them well behind the limit lines.

12. For safety reasons goal posts may not be inside the field. They must be on the end lines or, failing that, outside them. If the goal posts cannot be moved, the length of the field must be reduced.
13. The top of the crossbar should be 10ft from the ground. The uprights should be 18ft 6in apart – measured between the insides of the uprights. The uprights should be at least 30ft high. (N.B. A standard rugby goal that has a 3m crossbar and uprights 5.6m apart is acceptable.) The posts must be padded with resilient material from the ground to a height of at least 6ft.
14. Soft flexible four-sided pylons 4in x 4in with an overall height of 18 inches, which may include a 2in space between the bottom of the pylon and the ground, are recommended. They should be red or orange in colour and placed at the inside corners of the eight intersections of the sidelines with the goal lines and end lines. The pylons marking the intersections of the end lines and hash marks extended should be placed 3ft outside the end lines.
15. All field dimension lines should be 4in in width, marked with a white non-toxic material (Exception: sidelines and end lines may exceed 4in). If white is unsuitable, choose another contrasting colour.
16. Advertising or decorative markings on the field are permissible. In the end zone, they must not be closer than 4ft to any line unless in a contrasting colour. In the field of play, they must not obliterate any line.

Field dimensions metric converter

The following table lists field dimensions with their metric conversions. Columns 5 and 6 refer to the minimum dimensions when using IFAF yards (Rule 1-2-1-a).

Dimension	Feet	Yards	Metres (1 yd = 0.9144m)	Min IFAF yds as yds (1 Iyd >= 0.9478yds)	Min IFAF yds as metres (1 Iyd >= 0.8666m)
Length between goal lines	300.0	100.00	91.440	94.78	86.665
Length between end lines	360.0	120.00	109.728	113.73	103.998
Length between limit lines (6ft minimum around)	372.0	124.00	113.386	117.52	107.464
Length between limit lines (12ft around)	384.0	128.00	117.043	121.32	110.931
Length between limit lines (18ft recommended around)	396.0	132.00	120.701	125.11	114.398
Width between sidelines	160.0	53.33	48.768	50.55	46.221
Width between coaching box lines (6ft outside each sideline)	172.0	57.33	52.426	54.34	49.688
Width between team area lines (12ft outside each sideline)	184.0	61.33	56.083	58.13	53.154
Width between limit lines (18ft recommended around)	196.0	65.33	59.741	61.92	56.621
Width between team area back lines (if at 24ft outside each sideline)	208.0	69.33	63.398	65.71	60.088
Distance between 5 yard lines	15.0	5.00	4.572	4.74	4.333
Distance between sideline and coaching box line	6.0	2.00	1.829	1.90	1.733

Dimension	Feet	Yards	Metres (1 yd = 0.9144m)	Min IFAF yds as yds (1 Iyd >= 0.9478yds)	Min IFAF yds as metres (1 Iyd >= 0.8666m)
Distance between coaching box line and team area line	6.0	2.00	1.829	1.90	1.733
Normal size of end zone	30.0	10.00	9.144	9.48	8.666
Minimum depth of end zone	21.0	7.00	6.401	6.63	6.067
Distance from sideline to hash marks	60.0	20.00	18.288	18.96	17.333
Distance from sideline to 9yd marks	27.0	9.00	8.230	8.53	7.800
Height of number	6.0	2.00	1.829	1.90	1.733
Width of number	4.0	1.33	1.219	1.26	1.156
Height of crossbar	10.0	3.33	3.048	3.16	2.889
Width between goal uprights	18.5	6.17	5.639	5.84	5.344
Minimum height of uprights above crossbar	20.0	6.67	6.096	6.32	5.778
Width of line markings (4 inches)	0.33	0.11	0.102		
Space between yard lines and sideline (4 inches)	0.33	0.11	0.102	0.11	0.096
Length of short yard line extensions (hashmarks)	2.0	0.67	0.610		
1 yard	3.0	1.00	0.914	0.95	0.867
1 foot	1.0	0.33	0.305	0.32	0.289
1 inch	0.0833	0.0278	0.025	0.03	0.024

Appendix E

Equipment: Additional Details

1. Hard or unyielding substances are permitted, if covered, only to protect an injury.
2. Hand and arm protectors (covered casts or splints) are permitted only to protect a fracture or dislocation.
3. Thigh guards may not be made of any hard substances, unless all surfaces are covered with material such as closed-cell vinyl foam that is at least 1/4-inch thick on the outside surface and at least 3/8-inch thick on the inside surface and the overlaps of the edges.
4. Shin guards must be covered on both sides and all edges with closed-cell, slow-recovery foam padding at least 1/2-inch thick, or an alternate material of the same minimum thickness having similar physical properties.
5. Therapeutic or preventive knee braces should be worn under the pants and entirely covered from direct external exposure.
6. There may be no projection of metal or other hard substance from a player's person or clothing.
7. Shoe cleats must conform to the following specifications:
 - (a) They may not be more than 1/2-inch in length (measured from tip of cleat to the shoe). (See below for an exception for detachable cleats.)
 - (b) They may not be made of any material that burrs, chips or fractures.
 - (c) They may not have abrasive surfaces or cutting edges.
 - (d) Nondetachable cleats only may not be made of any metallic material.
 - (e) Detachable cleats:
 - (i) Must have an effective locking device.
 - (ii) May not have concave sides.
 - (iii) If conical they may not have flat free ends not parallel to their bases or less than 3/8-inch in diameter or rounded free ends having arcs greater than 7/16-inch.
 - (iv) If oblong they may not have free ends not parallel with bases or that measure less than 1/4-inch by 3/4-inch.
 - (v) If circular or ring shaped they must have rounded edges and a wall at least 3/16-inch thick.
 - (vi) If steel-tipped they must contain low carbon steel of 1006 material, case hardened to .005-.008in depth and drawn to Rockwell hardness of approximately C55.

NOTE: The distance in paragraph (a) for detachable cleats may exceed 1/2-inch if the cleat is attached to a 5/32-inch or less raised platform wider than the base of the cleat and extended across the width of the shoe to within 1/4-inch or less of the outer edges of the sole. A single toe cleat does not require a raised platform that extends across the width of the sole. The raised platform of the toe cleat is limited to 5/32-inch or less. The 5/32-inch or less is measured from the lowest point of the platform to the sole of the shoe.

8. The face mask must be constructed of nonbreakable material with rounded edges covered with resilient material designed to prevent chipping, burrs or an abrasiveness that would endanger players.
9. Shoulder pads may not have the leading edge of the epaulet rounded with a radius more than one-half the thickness of the material used.

10. No equipment that endangers other players may be worn. Artificial limbs are permitted provided:
 - (a) An artificial limb must not give the wearer any advantage in competition.
 - (b) If necessary, the artificial limb should be padded to rebound as a natural limb.
11. Logos and labels:
 - (a) Uniforms and all other items of apparel (e.g. warm-ups, socks, headbands, T-shirts, wristbands, visors, hats or gloves) may bear only a single manufacturer's or distributor's normal label or trademark (regardless of the visibility of the label or trademark) not to exceed 2¼ square inches in area (e.g. rectangle, square, parallelogram) including any additional material (e.g. patch) surrounding the normal trademark or logo. See also Rule 1-4-6-d.
 - (b) No sizing, garment-care or other non-logo labels shall be on the outside of the uniform.
 - (c) Professional league logos are prohibited.

EXAMPLES OF PERMISSIBLE FACEMASKS

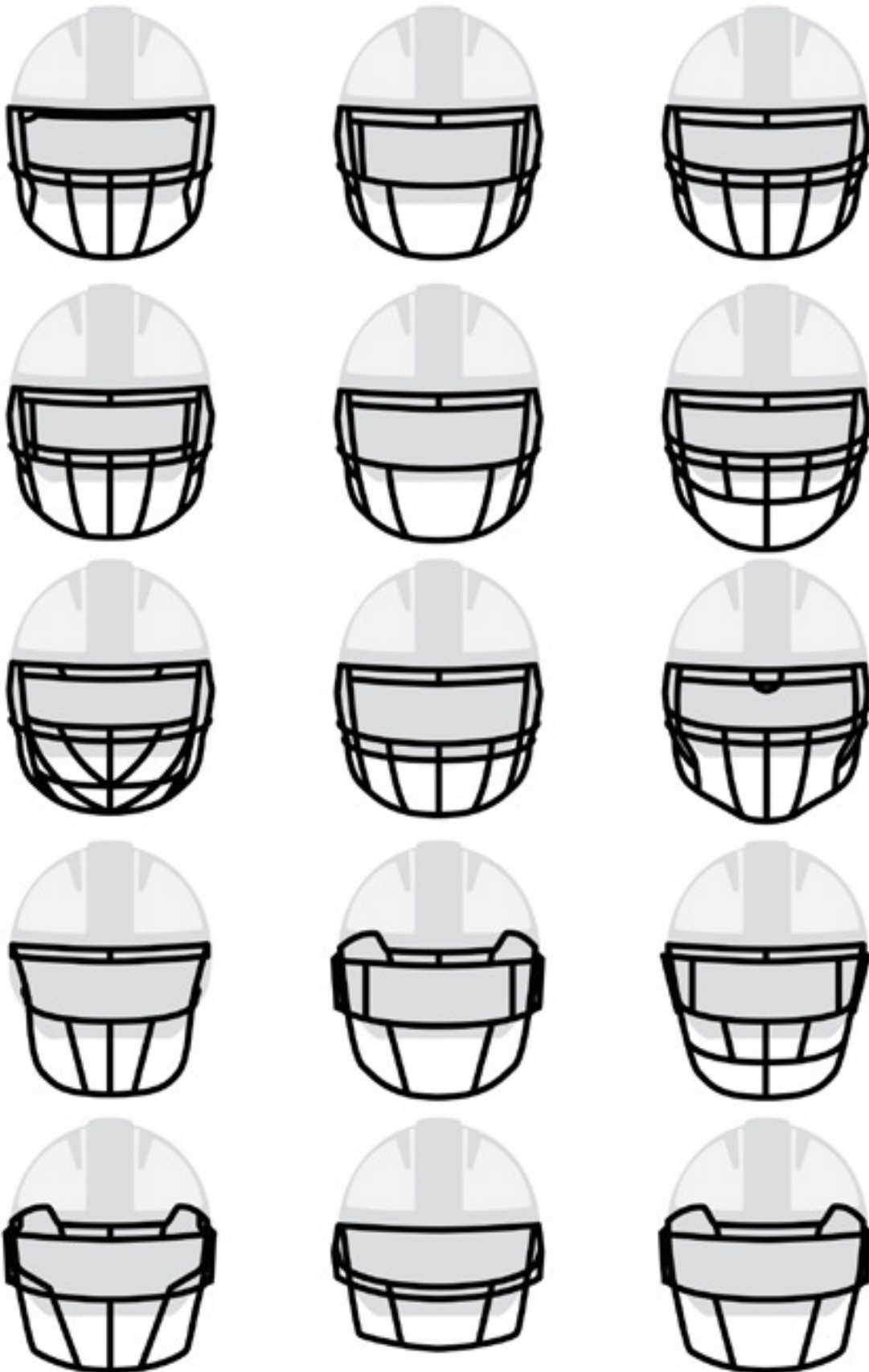

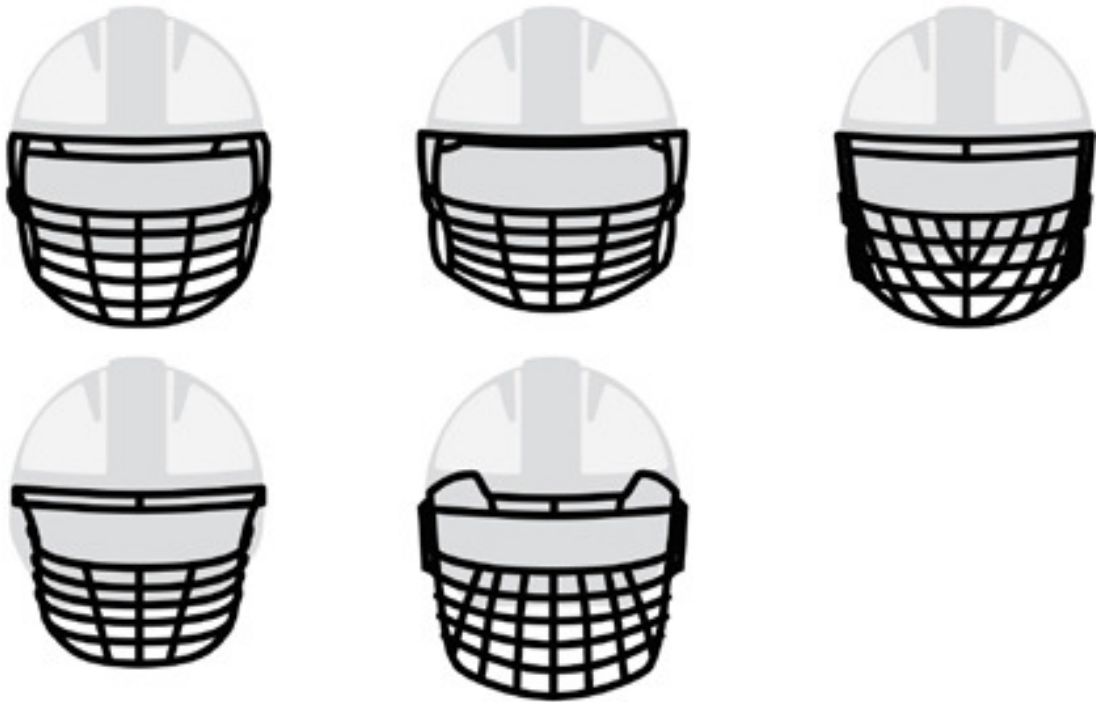
EXAMPLES OF NONSTANDARD/OVERBUILT FACEMASKS

As a general principle, any face mask with five or more horizontal bars below the eyes is not permissible. The exception is the face mask below - because of the larger gap between bars 2 and 3 and between 4 and 5, it is permissible.



Uniform details

FRONT VIEW

BACK VIEW

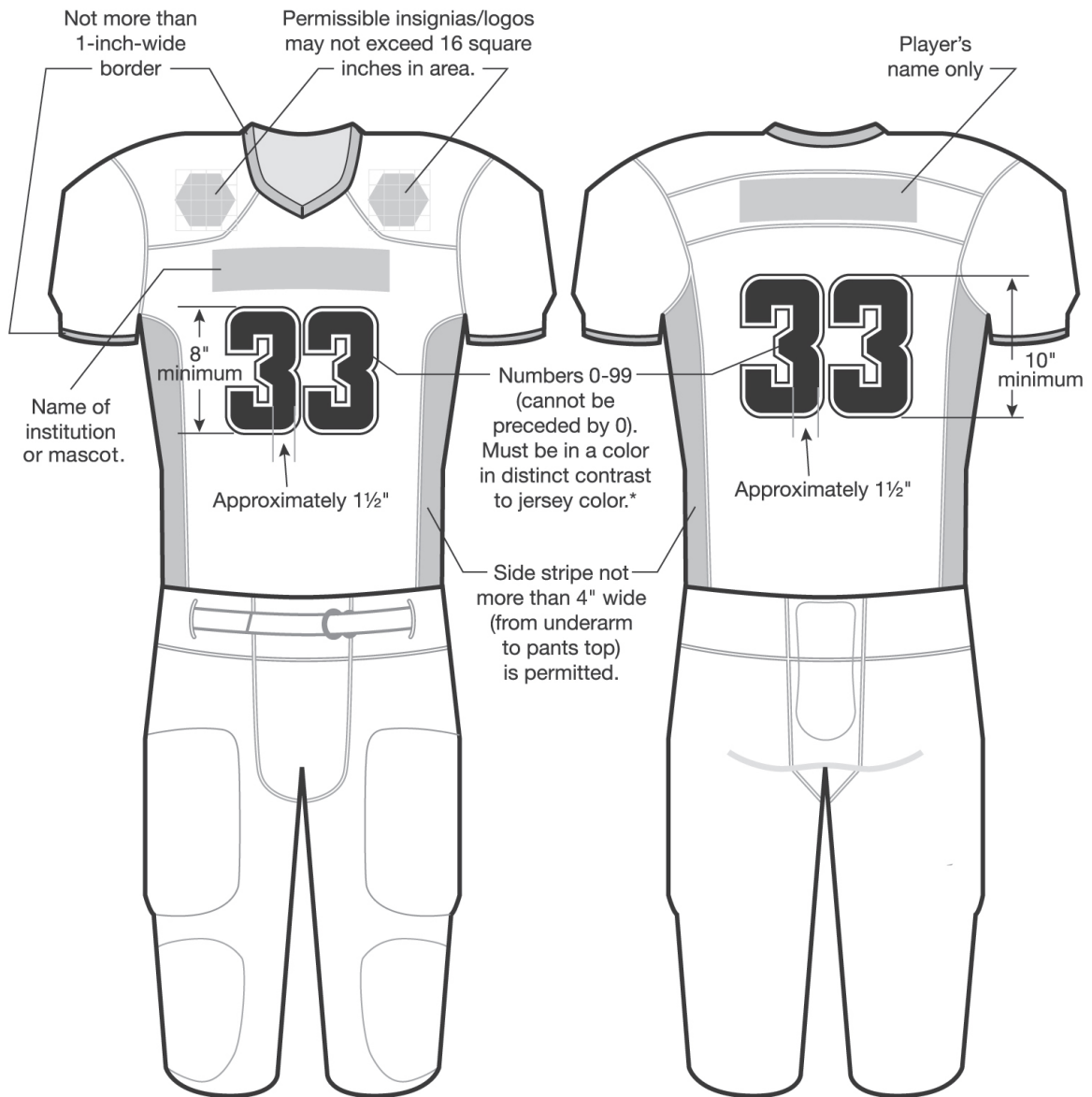

* Numbering rules are intended to provide a clearly visible number for a variety of groups (e.g., coaches, media, fans, etc.). Therefore, numbers must be designed to be clearly visible from a press box in a variety of weather and lighting conditions.

Uniform compliance

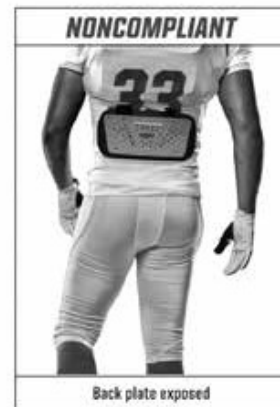
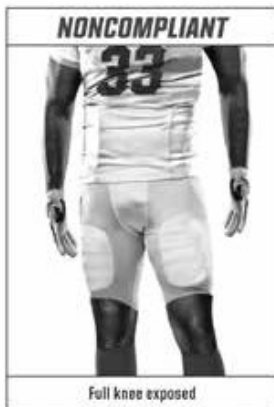
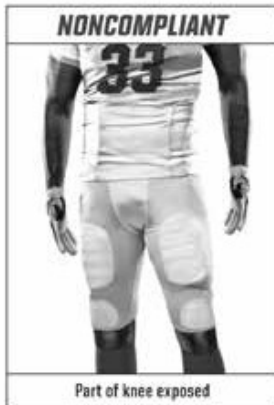
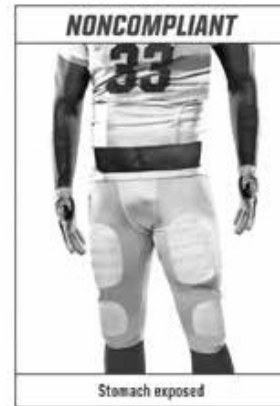
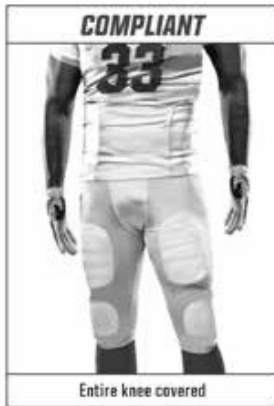

Rules application

Note: Changes marked in blue here are those made since the publication of the Manual of Football Officiating, 19th edition in 2023 and supersede that.

Foreword

Nobody wants to see a game where every minor infraction is penalised. This would much lengthen the duration of games and make the playing and spectating experience intolerable.

Historically, officials have used their experience to judge what is appropriate to flag and what not to flag. However, to leave that to each official's individual discretion would be to make the officiating of games too inconsistent. Hence we need guidelines to operate by.

These guidelines have appeared in Chapter 3 of each edition of the Manual of Football Officiating since 1993 and are widely accepted as being the appropriate philosophy for officiating American football. They are based on standards issued by the Collegiate Commissioners Association (for NCAA football) and revised by senior international officials with input from experienced coaches.

They are now in the rulebook to facilitate wider education about the principles under which the game is officiated. In any particular game, coaches and/or players should not expect that the rules are interpreted differently than described here. The referee's decision remains final.

NOTE: This version of the Rules Application is duplicated in both the 2026 IFAF Rulebook and the 20th edition of the Manual of Football Officiating. In future, updates will appear in the Rulebook and will supersede those in past editions of the MOFO.

RA 1 – Introduction and principles

1. These philosophies apply in full competitive adult games.
2. A stricter interpretation is appropriate in games involving junior/youth players and/or where the players are all obviously inexperienced.
3. A stricter interpretation is also appropriate in games where player conduct or attitude in general (i.e. not just one or two players) threatens to escalate the number or type of fouls committed. This may include clamping down on "minor" fouls when frustration may lead to "major" fouls.
4. A less strict interpretation of the rules is appropriate in blowout games when one team has a large lead and is obviously dominant. However, this should not extend to ignoring safety-related or conspicuous fouls.
5. Fouls in the open field are conspicuous enough to need calling whether or not they affect the play.
 - (a) It is likely that you will lose credibility if you do not call these.
 - (b) Our philosophy has moved from "did it affect the play?" to "was it conspicuous?". This reflects that more and more people watch games on video and therefore see things differently than if they are in the stands or on the side of the field.
 - (c) A less conspicuous foul still merits consideration of whether or not it affected the play. Major fouls (those that carry a 15-yard penalty or similar) should always be called.
6. If a flag is thrown for a foul where these principles indicate that it should not have been, the penalty should still be enforced. Generally, don't wave a flag off, once thrown, if it signifies a foul by rule.
7. Also bear in mind section 5.1 of the Manual of Football Officiating on common sense officiating.
8. Where a rule is not mentioned in this chapter, apply philosophy consistent with the following principles:
 - (a) Fouls affecting player safety should always be called.
 - (b) Fouls that are conspicuous should be called.

- (c) Fouls that give a team or a player a clear advantage should be called.
 - (d) Fouls that are minor/technical and probably unrealised by the players should result in a "talk to" for a first offence.
9. When we talk about gaining an advantage (or disadvantaging an opponent), pragmatically you probably have to make that decision within a couple of seconds of seeing the action. Waiting longer means that you might miss other action that you are responsible for and/or lose the spot of the foul.

RA 2 – Definitions

1. **Point of attack** is defined as follows:
 - (a) on a running play, it is the area in advance of the ball carrier – if they change direction the point of attack changes;
 - (b) on a forward pass play, it is anywhere in the vicinity of the passer or any player attempting to reach the passer, or in the vicinity of any eligible receiver running a pass route;
 - (c) on a scrimmage kick play, it is anywhere in the vicinity of the kicker or returner or any player attempting to reach the kicker or returner, or block the kick.
2. **Conspicuous:** An action is "conspicuous" if it would be visibly apparent to a spectator who knew the rules or to an official observing the game live or watching it on video. Generally, anything that takes place in the open field, or by a player standing alone, is conspicuous; anything that takes place in close line play or in a pile-up is not conspicuous. Examples of conspicuous fouls that should be called, even though they might otherwise be disregarded as "not serious", include:
 - (a) **takedown holding** (especially in the tackle box);
 - (b) **blocks in the back** in the open field;
 - (c) **illegal substitution** when a player leaves the field other than across their own sideline;
 - (d) **illegal substitution** when a team has 12 or more players in the huddle for more than 3 seconds (but don't nit pick the 3 second limit);
 - (e) **intentional illegal touching** of a forward pass;
 - (f) **false start** by a back, tight end or wide receiver;
 - (g) **offside** by Team B at their restraining line on a short free kick;
 - (h) **free kick out of bounds**.
3. **Brick in hand:** We sometimes use this term to refer to a player who we want to watch closely. Its origin is that if you saw someone outside a jeweller's window with a brick in their hand, you would be suspicious of what they would do next, and you would want to keep watching them to see if they threw it.
Examples include: when you see an offensive player chasing a defensive player, you might expect to see an illegal block in the back; when you see a player approaching an opponent at speed, you might expect to see an illegal blind-side block.

RA 3 – Contact fouls

1. **Offensive holding:**
 - (a) Only call it when *all* of the following conditions are met:
 - (i) the foul **is visibly apparent**, i.e. *it would show up on video*
 - (ii) the foul **affects the play or is conspicuous**, i.e. *it is clearly at the point of attack or is conspicuous, bearing in mind that the closer to the point of attack it is, the less it takes for it to need calling;*
 - (iii) the action **is demonstrably restrictive**, i.e. *the player is illegally slowed down or forced to take a longer route to their target;*
 - (iv) the foul **disadvantages the opponent**, i.e. *it actually moves the player opposite the way they want to go.*

- (b) Actions that constitute offensive holding include:
 - (i) **Grab and restrict** – grabbing the opponent’s body or uniform in a manner that restricts their ability to go in the direction they wish to go.
 - (ii) **Hook and restrict** – hooking a hand or arm around the opponent’s body (beyond the frame of the body presented to the blocker) in a manner that restricts their ability to go in the direction they wish to go.
 - (iii) **Takedown** – taking an opponent to the ground **by grabbing or hooking** when they don’t want to go to the ground. Note that it is **completely legal to push or otherwise** block an opponent to the ground, provided the hands or arms are used within the frame of the opponent’s body (or in the back in the free-blocking zone).
- (c) A player is **restricted** if:
 - (i) They are unable to turn or change direction due to continued, restrictive contact.
 - (ii) Their upper body is turned by the blocker having their arms around them.
 - (iii) They are unable to gain separation or to disengage from the opponent by turning, twisting, stopping, etc.
 - (iv) Their balance is changed or their natural foot movement is taken away.
- (d) **In the following circumstances, no advantage is typically gained**, so normally don’t call holding if *any* of the following conditions are met, unless the foul is really conspicuous:
 - (i) the held player makes the tackle **behind the neutral zone, or when the ball carrier made no extra yards as a result of the hold;**
 - (ii) the held player knocks down or intercepts a pass;
 - (iii) the held player **catches or** recovers a fumble;
 - (iv) at the point of attack on a run, the opponents are squared up, moving with each other and none of the restrictions above are noted;
 - (v) it happens at the same time as a tackle elsewhere on the field;
 - (vi) it is behind the neutral zone and a forward pass has already been thrown, or is in the process of being thrown;
 - (vii) it is part of a double-team block (unless a takedown occurs, or the defender breaks the double team and is pulled back);
 - (viii) it is the result of a defensive rip, i.e. the defensive player raising the offensive player’s arm;
 - (ix) the held player makes no effort to get free of the block, i.e. they "give up".
- (e) Holding an opponent’s jersey is *not* the same as holding the opponent. For a jersey pull to be a foul, there must be demonstrable restriction to the player’s movement.
- (f) Watching the *disengagement* of opponents is as important as watching their engagement. If a defender slides off a block and is able to proceed normally in the direction they want to travel (usually towards the ball), then it is unlikely that holding has occurred.

2. Defensive holding:

- (a) Downfield on pass plays, everywhere is the point of attack – a foul on an eligible receiver can occur anywhere.
- (b) Always call fouls that prevent the passer throwing the ball and lead to a sack.
- (c) **A clothesline block (or clotheslining) is usually made by a defender against an opponent (typically an eligible receiver) who is running at speed. The defender sticks out an arm as the opponent approaches, causing the opponent to run forcibly into the arm (typically forearm) at head or neck height, i.e. above the frame of the body (Rule 2-3-5). This should be called as a personal foul (and normally as targeting with the indicator being leading with the forearm).**
- (d) Contact that does not demonstrably impede a receiver should be ignored.

- (e) A grab of the receiver's jersey **before a pass is thrown** that restricts the receiver and takes away their feet should be called. **A grab after the pass is thrown is defensive pass interference if the ball is catchable by the fouled receiver.**
- (f) Holding should be called against defenders who clearly *illegally* restrict an offensive player from making a lead block for the ball carrier (this includes pulling linemen on trap and sweep plays), but not where the offensive player is too far away from the play to become involved.
- (g) Defensive holding should *not* be called for contact that occurs after the pass is thrown to the opposite side of the field (unless it is a clear attempt to restrict an offensive player as in (f) above). However, if the foul occurs anywhere while the quarterback still has the ball and is looking to pass, then call it, even though the ball might eventually be thrown elsewhere **or the quarterback sacked**. This could have had an effect on the play. The timing of the hold is important.
- (h) **Defensive holding should *not* be called for contact that occurs against an eligible receiver on the opposite side of the field to a designed running play. A foul may still be called if the run results from being unable to pass to the held receiver.**

3. **Illegal use of hands:**

- (a) **Apply the same conditions** as for offensive holding.
- (b) If the initial contact in a block is on the opponent's **helmet, face mask or neck** for more than a brief second, it should^x be called as a personal foul. **If the contact lasts a shorter time, it is probably illegal use of hands.**
- (c) Make sure you see the initial contact: it is not a foul if a player's hands slide up to a point above the opponent's shoulders.

4. **Blocks below the waist and clipping:**

- (a) When in **doubt**, the ball has not left the free-blocking zone (for blocks from the back).
- (b) For the first three seconds after the snap, when in **doubt**, the ball has not left the tackle box (for blocks from the front). Thereafter, when in **doubt**, the ball *has* left the tackle box.
- (c) To call clipping, you need to see two things:
 - (i) the blocker's last stride before the contact (so that you are fairly certain you know which direction they came from), *and*
 - (ii) you need to have seen the opponent they hit before the block (so that you know whether the opponent turned their back or not).

You must see the point of initial contact. Remember that contact to the side is **not clipping - it is covered by the blocking below the waist rule**. See the entire act.

- (d) Remember that it is the direction related to the opponent's area of concentration (not the point of contact) that determines whether a block below the waist is "directed from the front" or not.
- (e) It is not a foul for a block below the waist or clip if the contact occurs because the blocker **un-intentionally** slips or falls down and the opponent runs into them.

5. **Illegal block in the back:**

- (a) **Apply the same conditions as for offensive holding**, but also apply the conditions for calling clipping, particularly the need to see the entire act.
- (b) **In particular, blocks in the back that occur at or about the same time as the ball carrier is being tackled should not be called, unless they rise to the level of a personal foul.**
- (c) **When a maul has formed around the ball carrier (defensive players trying to tackle the ball carrier and offensive players trying to prevent them from doing so), this does not give anyone licence to block in the back. Blocks in the back of defensive players by offensive players should be called if the force from the contact moves the maul significantly forward or constitutes a personal foul.**
- (d) If one hand is on the **opponent's** number and the other hand is on the side and the initial force is on the number, it is a block in the back.

- (e) A block that starts in the side and ends up in the back is not a foul as long as there is continuous contact.
- (f) Touching an opponent in the back is not a foul unless it results in them being knocked down or pushed off balance sufficiently so that they stumble, misstep **or are pushed past the ball carrier** *and* miss making a tackle or block. Remember, the foul is for illegal *block* in the back, not an illegal *touch* in the back.
- (g) **Do not call an illegal block in the back on a fair catch if the illegal block occurs away from the play as the fair catch is being made, or the play results in a touchback. Personal fouls (such as unnecessary roughness or blind-side block) should always be called.**
- (h) Charging into a player's back^x may be called as unnecessary roughness **or as an illegal blind-side block**. This may be called regardless of the timing of the block relative to the end of the play.
- (i) Be particularly alert when you see an offensive player chasing a defensive player (and vice versa when the defensive player is not attempting to reach the ball). Imagine they have a brick in their hand. **When in "chase" mode, all action must be from the side to be legal.**
- (j) **A block in the back by a defensive player against a trailing offensive player is either a personal foul for unnecessary roughness, an illegal blind-side block or it is nothing.**

6. **Roughing the passer:**

- (a) If the defensive player's **main contact is on the passer's head**, it is always a foul unless the passer ducks into it or the contact is slight. However, it is only targeting if the contact goes well beyond making a legal tackle or attempting to block/deflect the pass.
- (b) Contact at the knee area or below on an offensive player in a passing posture is enforced according to Rule 9-1-9-b. Slight contact should be disregarded. **Don't be picky about the knee area - anywhere in the vicinity of the knee is a foul.**
- (c) It is a foul if a defender (in front of the passer) takes two steps before contacting the passer after the ball has been thrown/released. A defender behind the passer is given a little more leeway.
- (d) Defensive players who make a legitimate attempt to avoid or reduce contact are given the benefit of the doubt. A soft hit can still be a foul, if it is really late. (The later the hit, the lower the threshold of force needed to make it a foul.) **Any second act (distinct from the initial charge) is likely to be a foul.**
- (e) When in doubt, it is roughing the passer if the defender's intent is to punish.
- (f) When considering roughing the passer fouls, there are four possibilities:
 - (i) The contact is high (to the passer's head/neck area); timing doesn't matter. This will be a foul either for targeting (if the conditions for that are met) or for roughing the passer (forcible contact to the head/neck that doesn't rise to the level of targeting).
 - (ii) The contact is low; timing doesn't matter. The player must be in passing posture. Forcible contact to the knee area or below is a foul.
 - (iii) The contact is late; doesn't matter where on the passer's body. Contact after the pass is released that is punishing or avoidable is a foul.
 - (iv) Contact that is not punishing or forcible; even if high/low/late. This is not a foul.

7. **Roughing/running into the kicker:**

- (a) Generally, contact with the kicker's kicking leg will be considered as *running* into the kicker, and contact with their plant leg (even if it is off the ground) will be considered as *roughing* the kicker.
- (b) Any time the kicker or holder are knocked off their feet it should be called as *roughing*.
- (c) Where the kicker makes a move before the kick that is not part of the normal kicking motion, then it is no longer obvious that a kick will be made and there will probably be no foul unless the defensive player is out to punish them. Note that "rugby-style" kickers (those who kick on

the run) are entitled to as much protection as conventional kickers after they have kicked the ball. But any contact with a kicker before the kick is simply tackling a ball carrier.

- (d) Even if the snap is bad, a kick may still be obvious. Provided the kicker or holder gathers the ball and straight away goes into their normal motion, then they are entitled to protection (always assuming the ball is kicked). **Exception:** if the kicker carries or possesses the ball outside the tackle box or more than 5 yards behind their initial position.

8. Defensive pass interference:

- (a) Actions that constitute defensive pass interference include:

- (i) **Not playing the ball** – Early contact by a defender (who is not playing the ball) that impedes or restricts the receiver's opportunity to make the catch.
- (ii) **Playing through an opponent** – Playing through the receiver (i.e. contacting them in the back or on the side of them furthest from the ball), whether or not the defender is playing the ball.
- (iii) **Grab and restrict** – Grabbing the receiver's arm in a manner that restricts their opportunity to catch a pass.
- (iv) **Arm bar** – Extending an arm across the receiver's body to impede their ability to catch a pass, whether or not the defender is looking for the ball.
- (v) **Cut off** – Cutting off or riding a receiver out of the path to the ball by making contact with them without playing the ball (i.e. before the defender looks for the ball).
- (vi) **Hook and turn** – Hooking a receiver around the waist that causes their body to turn prior to (or even slightly after) the ball arriving (even if the defender is trying to get to the ball).

- (b) Actions that do *not* constitute defensive pass interference include:

- (i) Incidental contact by a defender's hands, arms or body in the act of moving to the ball that does not materially affect the route of the receiver. If in doubt as to whether the route was materially affected, there is no interference.
- (ii) Inadvertent tangling of feet when both (or neither) players are playing the ball.
- (iii) Contact occurring during a pass that is clearly uncatchable by the involved players.
- (iv) Laying a hand on the receiver that does not turn or impede them until after the ball has arrived.
- (v) Contact on a "hail mary" pass unless it is clear and conspicuous pass interference.
- (vi) Any action by a Team B player who is not aware of where the Team A player is. It is absolutely a requirement for DPI that there is obvious intent to impede.

- (c) Further notes:

- (i) A stationary player (in position to catch the ball) who is displaced from their position has been fouled.
- (ii) It is never pass interference if any player touches the ball before the defender contacts the opponent.
- (iii) Interference must be conspicuous to be called.
- (iv) Remember that the defense has as much right to the ball as the offense.
- (v) It is crucial to identify which players are playing the ball and which are not.
- (vi) Normally, an offensive receiver will try to catch the ball with two hands. If the receiver goes up with only one hand, is that because their other hand has been illegally obstructed? Often, a defender will try to bat/deflect the ball with only one hand. If the defender goes up with only one hand, know whether the other hand is doing something illegal.
- (vii) **Uncatchable pass:**
 - (1) When judging whether a pass is catchable, imagine how far the receiver could have run, and how high or wide they could have jumped, if they had not been impeded. The earlier the contact, the further the receiver could have moved towards the end of the pass.

(2) An uncatchable pass must be obviously uncatchable in order to disregard a foul for pass interference.

(viii) There is no foul when contact is simultaneous with the ball being touched ("bang-bang").
When in doubt, contact is simultaneous with the ball being touched.

9. Offensive pass interference:

(a) Actions that constitute offensive pass interference include:

- (i) **Pushing off** – Initiating contact with a defender by shoving or pushing off, thus creating a separation in an attempt to catch a pass.
- (ii) **Driving through** – Driving through a defender who has established a position on the field.
- (iii) **Blocking** – Before the pass is thrown, blocking that occurs anywhere down field. After the pass is thrown, blocking that occurs down field within approximately 20 yards (more if the pass is delayed) of where the pass is thrown to.
- (iv) **Pick** – Picking off (initiating contact with) a defender who is attempting to cover a receiver. Remember that intent to impede is not necessary for offensive pass interference - it is sufficient that the defender was interfered with. It is not a foul if the contact occurred at the same time as the pass was touched.

(b) Actions that do *not* constitute offensive pass interference include:

- (i) Incidental contact by a receiver's hands, arms or body in the act of moving to the ball that does not materially affect the route of the defender. If in doubt as to whether the route was materially affected, there is no interference.
- (ii) Inadvertent tangling of feet when both (or neither) players are playing the ball.
- (iii) Contact during a pass that is clearly uncatchable by the involved players.
- (iv) Blocking downfield when the pass is legally grounded out of bounds or near the sideline. (**Exception:** Blocking downfield can still be called if the forward passer is legally grounding the ball other than out of bounds or near the sideline.)
- (v) When an intended screen pass is overthrown and lands beyond the line of scrimmage and linemen are blocking downfield, unless that blocking prevents a defensive player from intercepting the ball.
- (vi) Contact on a pick play when the defensive player is already blocking the offensive player, or if the offensive player's body is not entirely beyond the neutral zone.
- (vii) Contact on a "hail mary" pass unless it is clear and conspicuous pass interference.

(c) Further notes:

- (i) Non-flagrant contact well away from the play should not be called.
- (ii) If in doubt as to which player initiated a block, the initiator will be the one who is upright or leaning forward and the player blocked will be knocked back.
- (iii) Blocking downfield by the offense (against a player in pass coverage) on a forward pass play before the ball is thrown is always offensive pass interference. The defense (particularly the safeties) may see a block and read the play as a run, so drawing coverage away from the destination of the subsequent pass. ×

10. Late hit:

- (a) The *later* the hit, the less forcible the contact needs to be to warrant a flag. The *earlier* the hit, the more forcible the contact needs to be to warrant a flag. Be more likely to call it the later the hit or the more severe the contact. Slight contact immediately after the ball is dead should not be called. The more badly-behaved either team has been earlier in the game, the more likely you should be to call a foul to maintain game control.
- (b) Any deliberate push against a ball carrier out of bounds is a foul.
- (c) When a ball carrier is near the sideline, contact that occurs before the ball carrier has a foot down out of bounds is a legal hit, but must be proportionate - i.e. the minimum needed to force the ball carrier out.

- (d) When a ball carrier is out of bounds but continues running down the sideline in bounds, any subsequent hit is legal provided they have not eased up and the whistle has not blown. **Once the whistle has blown, any forcible contact is a foul.**
- (e) **When a ball carrier is obviously easing up near the sideline, little defensive force should be necessary to ensure they go out of bounds. Attempts to "punish" the ball carrier should be penalised as unnecessary roughness. Quarterbacks should be given more protection under this than other ball carriers.**
11. **Face mask:** Remember that a face mask foul involves *grasping* the helmet or face mask, not simply *touching* it.
12. **Unnecessary roughness:**
- (a) An act that occurs well away from the play may be classed as a personal foul even though the act itself is legal. In other words, it is the location of the players with respect to the play that causes the foul, not the legality of the contact.
- (b) Be certain that the act wasn't justified by the play situation (e.g. an interception or fumble return or a broken play). If a player is in position to influence the play or moving towards it, they are a fair target: if they are standing still, they are not.
- (c) It is not a foul if two players are each blocking each other – only contact against a player off their guard needs to be penalised.
- (d) For unnecessary hits away from the ball near the end of a play, make them dead-ball fouls rather than live-ball ones.
- (e) When a player is hit after giving themselves up **or sliding**, a foul is warranted.
- (f) After a touchdown, if there is forcible contact on the ball carrier that is obviously late and intentional, a foul must be called.
13. **Roughing the snapper:**
- (a) This foul can only occur when it is reasonably obvious that a scrimmage kick will be made: i.e. only on field goal and PAT attempts, or when a team lines up in **an obvious punting formation on 3rd/4th down**.
- (b) Don't be picky about the one second interval. If the snapper is upright before the one second has elapsed then permit contact, but if they take longer to recover then allow them more protection.
- (c) Don't call a foul if a defensive player contacts the snapper after being blocked by an adjacent offensive lineman.
- (d) Disqualify any player who attempts to punish by contact to the snapper's helmet or spears using the defender's own helmet.
14. **Targeting:**
- (a) The definition of a defenseless player is per Rule 2-27-14. If in doubt, a player is defenseless.
- (b) If a hit isn't late, then the ball carrier cannot be defenseless with respect to targeting. A hit that is simultaneous with (or a fraction of a second after) a ball carrier's knee down, is not late.
- (c) Checklist for targeting fouls (adapted from Dean Blandino presentation, 2021):
- (i) Is the player being hit defenseless (Rule 2-27-14)? If yes, then Rule 9-1-4 is in scope. If no, then only Rule 9-1-3 is in scope.
- (ii) Is an indicator of targeting present (Rule 2-35)? **Which parts of Rule 2-35-1 apply? If none, there is no targeting.**
- (1) What was the body posture of the initiator? If their head stays up then there is less chance of it being an indicator than if they lower it. What body part are they leading with? **Is their trajectory upward (which is an indicator) or do they just run through (which is not)?**
- (2) Was the initiator attacking with force? An attack involves forward, upward or downward movement. If they are stationary, they are absorbing contact.

(iii) Was the contact with the initiator's crown or at the opponent's head/neck area?

(iv) Was the contact forcible?

15. Horse collar tackle:

- (a) **The three requirements** to call this are (i) the defender grabs the collar or name plate area; (ii) the ball carrier or simulated ball carrier is pulled towards the ground; **and (iii) the ball carrier or simulated ball carrier is pulled backwards (not sideways or forwards) (A.R. 9-1-15:II).**
- (b) As with other safety related fouls, if in doubt as to whether it is a foul or not, call it.
- (c) However, just grabbing another part of the jersey and pulling a ball carrier or simulated ball carrier down is not a foul.

16. Chop block:

- (a) It is not a foul if either the high or low player involved simply brushes past or makes only slight contact with the opponent. There must be force enough in each block to change the velocity of the relevant part of the opponent's body.
- (b) By rule it is not a foul if the defensive player initiates the contact.

17. Blind-side block:

- (a) "Forcible contact" requires a build up of momentum. It is less likely to occur if a player is moving slowly. It is more likely to occur the further a player has run at high speed. **Momentum is a combination of mass and velocity. Bigger players don't have to run so fast to build up momentum.**
- (b) When a blocker contacts an opponent with outstretched hands or arms, their elbows and shoulders will inevitably cushion the impact, so making the force less.
- (c) A player who is standing still or moving slowly cannot be "attacking an opponent" and therefore can't be guilty of an illegal blind-side block. **This includes a stationary (or nearly stationary) player who, by not moving out of the way, allows an opponent to run into them. That player is also allowed to brace themselves for the impact without creating a foul for a blind-side block.**
- (d) An "open field" block generally (i) is outside the tackle box or after the tackle box has disintegrated or after the O-line disperses; (ii) is more than 2 seconds after the snap; and (iii) involves players who typically were more than 5 yards from each other 2 seconds before the block.
- (e) Be particularly alert when you see a player:
 - (i) approaching an opponent at speed from the side or behind;
 - (ii) going "upstream", i.e. moving in the opposite direction to all other players (e.g. during returns after change of possession);

In each case, imagine they have a brick in their hand.

18. Kick-catch interference:

- (a) Anything that impedes the receiver from the opportunity to catch the ball should be called a foul. Their balance will have been disturbed, so hindering their ability to catch the ball cleanly. **When in doubt, it is a foul.** This includes:
 - (i) contact with the receiver (however incidental);
 - (ii) running menacingly close to the **receiver and within their area of focus/vision;**
 - (iii) standing too close to the receiver;
 - (iv) yelling or making other intentional noise while close to the receiver;
 - (v) waving arms in front of the receiver;
 - (vi) forcing the receiver to step around the opponent or change path in an effort to catch the ball.
- (b) It is not a foul where:
 - (i) the Team A player runs past the receiver without touching them or making them change course;

- (ii) the receiver "gives up" their attempt to catch the kick too easily;
 - (iii) the receiver catches the ball and there was no contact and the extent of any non-contact interference is slight or in doubt: don't award cheap 15-yard penalties.
 - (c) A player who viciously contacts a potential kick receiver has committed a flagrant personal foul and should be disqualified. Give only the personal foul signal (not the signal for kick-catch interference) in this case.
 - (d) A player who is in the process of catching a kick must be given an unimpeded opportunity to complete the catch before being contacted. This protection terminates if the player muffs the ball, unless they have given a valid fair catch signal and still have an opportunity to complete the catch (Rule 6-5-1-b).
19. **Summary:** When considering personal fouls, ask whether the potential offender had options. Could they have chosen to do something differently with respect to the contact? Penalise players who choose the bad option.

RA 4 – Non-contact fouls

1. **Delay of game:**
 - (a) If Team A is still in the huddle, or moving into formation, with 10 seconds to go, warn them verbally that there are 10 seconds remaining. Always throw the flag when the count reaches zero, unless the snap is very imminent (i.e. the quarterback is calling out "huts"), in which case they can have an extra second.
 - (b) If there is a visible play clock, when it reaches zero, look and see if the ball has been snapped. If it has not, throw a flag.
 - (c) After a score, it is a delay of game if either team is not on the field (or on the field but still in the huddle) within one minute regardless of whether the ready for play has been given or not. For a first offence, warn the head coach of the team rather than throw a flag. **(Warn for first offence and penalise second and subsequent.)**
 - (d) If no **(or few)** players from Team B are ready to play anytime when Team A is set to snap the ball, penalise Team B for delay of game. Do *not* give Team A a free play. Near the end of a timeout (usually 15 seconds before the end), the officials on the sideline are responsible for ensuring that the captain or coach of the team knows that the timeout is about to end.
 - (e) If Team A makes last second substitutions (rushing to the line of scrimmage while in the process of substituting), Team B must be given an opportunity to "match-up". If the play clock expires prior to the snap, the officials must determine whether Team B was given ample opportunity to react to the "rushed" substitution. If Team B reacts promptly but the play clock expires, Team A will be assessed a delay of game foul. **If any Team B players do not leave and enter the field of play quickly, or do not start the process within 3 seconds of Team A's last substitute entering the field of play, (i) Team A shall be allowed to snap the ball and (ii) if Team B has more than 11 players on the field of play, it will be penalised for illegal substitution. (Rule 3-5-2-e.)**
 - (f) If Team A snaps the ball in a situation where they have been asked not to (e.g. while Team B are being allowed to make matching substitutions), for a first **unintentional** offence shut down the play and issue a warning. **(Warn for first offence and penalise second and subsequent.) (Rule 3-5-2-e)**
2. **Players not within the nine-yard marks:** Don't call this if Team B reacts to the offending player, e.g. by a Team B player lining up opposite them.
3. **Illegal formation and eligibility of receivers:**
 - (a) Don't wait until the fourth quarter to enforce these rules - deal with illegal formations as soon as they first arise.
 - (b) It is always a foul when Team A has five (or more) players in the backfield at the snap. Team A gains a blocking advantage by being further away from the defense.

- (c) It is still a foul for five players in the backfield even if Team A has only 10 (or fewer) players on the field at the snap.
 - (d) Work to keep offensive linemen legal. Only call an intended offensive lineman as being in the backfield if:
 - (i) it is obvious (clear gap between their head/shoulders and the nearest Team A lineman), or
 - (ii) they are lined up with their head clearly behind the rear end of the snapper - a foul to be called without warning, or
 - (iii) when a warning to the player and a subsequent warning to the coach are ignored. (Warn for first and second offence and penalise third and subsequent.)
 - (e) Give more leeway to wide receivers and slot backs in determining whether they are on or off the line of scrimmage than you do to interior linemen or tight ends. Be particularly generous on fields that are not well marked out.
 - (f) Only regard a wide receiver as covering an inside receiver on the line of scrimmage if there is no stagger between their alignments. If in doubt, the inside receiver is *not* covered up.
 - (g) In determining the number of players in the backfield, be generous to players who may not precisely meet the requirements of Rule 2-27-4. If a Team A player is borderline, regard him as a back if there are fewer than 4 backs; regard him as a lineman if there are fewer than 7 linemen. If there are multiple borderline players, do the above for each.
 - (h) Remember that if Team B sees a player with an eligible number lined up near the line of scrimmage, they will assume they are also eligible by position. Similarly, if Team B sees a player with an ineligible number lined up near the line of scrimmage, they will assume they are on the line of scrimmage.
 - (i) On a trick or unusual play, formations should have the highest degree of scrutiny and should be penalised unless they are *completely* legal.
4. **Snapper moving the ball:**
- (a) When taking their stance, permit the snapper to move the ball forward no more than a ball length, and never across the line to gain or goal line. If they move it forward more, shut down the play, reset the ball and warn the player and their coach that further infractions will be penalised. (Warn for first offence and penalise second and subsequent.)
 - (b) When taking their stance, if the snapper lifts the ball off the ground, shut down the play, reset the ball and warn the player and their coach that further infractions will be penalised. (Warn for first offence and penalise second and subsequent.)
 - (c) If the snapper simply rotates the ball in place (e.g. to improve their grip), this is not a problem.
5. **False start:**
- (a) Movement by a Team A player is not a false start unless it:
 - (i) is movement of one or both feet; or
 - (ii) is sudden; or
 - (iii) causes a defensive player to move in immediate reaction and this is the first time such movement has been observed; or
 - (iv) is a restricted lineman lifting their hand(s).
 - (b) If a back misses the snap count, makes a sudden movement and then stops abruptly, it is a false start. (If they were genuinely going into motion, they wouldn't stop.)
 - (c) Team B's "immediate reaction" needs to be a typical play response. Merely pointing at Team A players who may have moved is NOT.
 - (d) Don't be picky: if in doubt as to whether movement was prior to the snap or not, it was *not*.
 - (e) When in doubt, a quick or abrupt movement by the snapper or quarterback *is* a false start.

6. Offside:

- (a) When a defensive player, before the snap, moves and an offensive player subsequently moves, a conference between the Umpire and the wing officials is mandatory. This is to determine if the defensive player was in the neutral zone and if the offensive player was threatened. **When in doubt, the defensive player was in the neutral zone.** When in **doubt**, the offensive player *is* threatened. If the Team A player who first moves is not threatened, it is a false start.
- (b) When a defensive player, before the snap, crosses the neutral zone and charges towards a Team A back, it is a dead-ball offside foul. The time to call this as a foul is when the defender passes the hip of the nearest Team A lineman.
- (c) **When in doubt whether a defensive player who has crossed the neutral zone contacted a Team A player, there was contact.**
- (d) Don't rule a defensive player offside if they are stationary and only intruding on the neutral zone by a trivial amount.
- (e) Don't be picky about offside, particularly on fields that are not marked perfectly.
- (f) Don't call offside if the defensive player is moving forward at the snap but is not actually in the neutral zone.

7. Team B movement and signals:

- (a) A "stem" is where a Team B lineman moves laterally, and the movement is at least enough to change from head-up on one opponent to head-up on another, or from head-up to gap between two opponents, or vice-versa.
- (b) When there is a coordinated movement by two or more Team B linemen, the signal to initiate it must not come from a lineman.
- (c) A movement by a Team B lineman that constitutes a stem is legal. A quick, abrupt or exaggerated movement by a Team B lineman that is not a stem (e.g. stamping a foot, waving an arm) should be interpreted as an attempt to get Team A to false start.
- (d) The following are fouls by Team B:
 - (i) Replicating a Team A starting signal (e.g. words or a clap), whether or not Team A reacts. Other than a clap, it is not a foul to make a noise that Team A isn't using, or to make hand gestures that don't create a clapping sound.
 - (ii) A quick, abrupt or exaggerated movement by a defensive lineman that is not a stem *and* causes Team A to false start.
- (e) Penalise a Team A player for delay of game if they use words that sound like "move" or "stem" (Rule 7-1-5-a-5).
- (f) With the exception of disconcerting signals, infractions under Rule 7-1-5 only become a foul if Team A reacts and does so authentically. If legal movement by a Team B lineman causes a Team A player to reach into the neutral zone and touch the Team B player, it is an encroachment foul on Team A. That is not an authentic reaction to being threatened.

8. Illegal motion: A player is in illegal motion only if their forward movement is conspicuous. A motion man angling forward while in motion at the snap has committed a live-ball foul, not a false start.

9. Ineligible receiver downfield:

- (a) Call it only if it is conspicuous.
- (b) An ineligible receiver must be clearly more than 3 yards down field at the time the pass is thrown - don't be picky if the player is just at 3 yards. Be cautious that if a player is seen 5 yards downfield and moving downfield as the ball passes them, they were probably not more than 3 yards downfield when the ball was thrown.
- (c) If a lineman blocks downfield, call it as ineligible downfield unless they go far enough to block a **defensive player** in pass coverage in which case call it as offensive pass interference.

- (d) By rule, it is not a foul for ineligible receiver downfield if the pass is legally thrown away near or beyond the sideline.
- (e) See RA 4.3.f above for determining whether a Team A player is eligible or not.
- (f) Don't call it if the offense is legally throwing the ball beyond the neutral zone to save a loss of yardage.
- (g) Don't call it if a screen pass is overthrown and lands beyond the neutral zone, unless the presence of the ineligible receiver prevents a defensive player from catching the ball.

10. Intentional grounding:

- (a) Don't call it if the passer was contacted clearly *after* they have started the act of throwing the ball, or if the ball was touched. Under these circumstances, you must assume the passer intended to throw the ball to a receiver.
- (b) Do call it if the passer was contacted *before* they have started their throwing motion. They are not allowed to throw the ball away to avoid a sack. In some circumstances it may be appropriate to rule the ball dead (rather than penalise for intentional grounding) because they were held and their forward progress stopped.
- (c) Do not call intentional grounding if the passer throws the ball away **when not under defensive pressure**. They are entitled to waste a down if they are in no danger of being sacked. The clock is not a factor. (**Exception: if the passer throws the ball only a few yards - typically less than 5 yards from them.**)
- (d) There is no need to call **intentional grounding** if the pass is intercepted *and* this would be the only foul called.
- (e) Getting the ball to within one yard of the neutral zone is to be regarded as close enough. Don't be technical on this.
- (f) **When in doubt whether the forward passer is or has been outside the tackle box, they are or have been outside the tackle box.**
- (g) If a pass is touched by an ineligible receiver, it will normally just be a foul for illegal touching. However, if the passer does this in an obviously deliberate manner to avoid a loss of yardage, then a foul for intentional grounding is justified. By rule, you cannot have illegal touching on an illegal pass.

11. Illegal substitution:

- (a) If a replaced player is leaving the field of play or end zone but is still clearly on the field of play at the snap, then it should be called as a foul.
- (b) A replaced player who re-enters the field after leaving it has fouled. However, a player who leaves the field believing they are being replaced, but who is not in fact replaced, should be allowed to re-enter without penalty (provided this is not a deception).
- (c) If substitutes enter the field thinking the ball is dead but don't interfere with play, then don't call it.
- (d) If the offense breaks its huddle with **too many** players on the field, this confuses the opposition and should be penalised. However, there can be a foul only if the ball has been declared ready for play (Rule 2-14) or the 12th man does not leave the huddle immediately.
- (e) If the defense has **too many** players on the field when the snap is imminent,[×] there is no foul until the ball is snapped, **unless Rule 3-5-3-c applies.**
- (f) Fouls associated with the substitution process and having **too many** players on the field will normally be violations of Rule 3-5. However, an intentional attempt to confuse opponents will be penalised for unfair tactics (Rule 9-2-2-b).

12. Failure to wear mandatory equipment:

- (a) Regard failure to have a mouthpiece or to secure all points of a chinstrap as seriously as failure to wear a helmet. If you observe a player leaving the huddle without a mouthpiece or chinstraps, remind them to secure their equipment. Players who ignore the reminder must be dealt

with by rule (Rule 1-4-8), but give quarterbacks and other players calling signals more time to do so. The same procedure applies to players wearing opaque or mirrored eye shields.

- (b) Do not stop either the game clock or play clock **unless you are charging a team with a timeout due to a player not responding to 2 notifications to leave the field.** If a player does respond and leave the field, Team A needs to ensure it snaps the ball before the play clock expires and Team B needs to ensure it has no more than 11 players on the field at and after the snap. If a restricted lineman needs to be replaced, it will be a false start when they stand up, **unless Team A takes a timeout.**
 - (c) For other non-critical mandatory equipment, instruct the player to remedy the problem the next time they are off the field. If they ignore the instruction, when they return to the field tell them to go off and fix the problem immediately. If they do so, then fine. If their team replaces them immediately, do not penalise for an illegal substitution. If their team takes a timeout or suffers a delay of game penalty, that is their choice. If they stay and attempt to participate in a play, deal with them by rule (Rule 1-4-8).
13. **Illegal equipment:** Anything that might be a risk to participant safety must be dealt with before the ball is next put in play. Other infringements may be left for the player to rectify next time they leave the field, but must be rectified before they can legally return.
14. **Illegally kicking the ball:** If a player intentionally contacts the ball with knee, lower leg or foot with the objective of propelling the ball in any direction, they are kicking it. If it touches their knee, lower leg or foot incidentally or as part of an attempt to obtain possession of the ball, this is not regarded as a kick and there is no foul.
15. **Illegal wedge:** For a wedge to be illegal (Rule 6-1-10), it has to form before the end of the kick and continue during the beginning of the return. If they touch/hold hands, this is a dead giveaway. It is *not* an illegal wedge if they are moving towards their own end line. Once the return gets up-field, players will come together as a consequence of the play – this is *not* considered as an illegal wedge.
16. **Offside on free kick:**
- (a) Officiate the Team A restraining line as a plane (**at the edge of the line nearest Team A's goal line, if you have replay**).
 - (b) On an onside or other short kickoff (**intentional** or unintentional), any player (other than the kicker or holder) breaking the plane before the ball is kicked is offside.
 - (c) On a deep kickoff, do not be too technical.
 - (d) Only call a foul if a kicking team player (other than the kicker) obviously takes a run up of more than 5 yards on a free kick. Players who simply adjust their position or stance should not be penalised for being temporarily more than 5 yards behind. The aim of the rule is to reduce a player's momentum at kickoff.
17. **Handing the ball forward illegally:** Handing the ball forward (except where allowed by rule) is always a foul. A team can gain significant yardage (as well as the benefits of deception) from this illegal play.
18. **Team A player out of bounds:**
- (a) Whenever any Team A player returns inbounds after voluntarily going out of bounds during a kick play, or an eligible receiver touches the ball illegally after voluntarily going out of bounds during a pass play, it is always a foul. A Team A player leaving the field of play gains an advantage by avoiding being blocked. Remember that a player is out of bounds even if only one foot touches the sideline or end line – this **should not be ignored**.
 - (b) Any contact by a Team B player that causes a Team A player to go out of bounds should be regarded as the cause of it, provided the Team A player attempts to come back in bounds immediately.

19. **Continued participation without helmet:** "The immediate action in which they are engaged" ends once a player disengages from contact with an opponent and is no longer confronting, or being confronted by, that opponent. A player who loses their helmet while engaged with an opponent (including when overpowering an opponent) is expected to disengage when it is safe to do so. A player whose helmet comes off without being engaged or confronted by an opponent (i.e. they are just running) cannot continue to participate from that point.

RA 5 – Unsportsmanlike conduct and fighting

1. Celebration:

- (a) Celebration is different from taunting – be more tolerant of it. Allow brief, spontaneous, emotional reactions at the end of a play. Penalise prolonged, self-congratulatory or demeaning acts.
- (b) A "sack dance" over a tackled opponent should always be penalised.
- (c) Always penalise spiking the ball after a play, except for a spontaneous celebration after a score (or where the player reasonably believes they have scored). However if this is in the direction of an opponent (even unintentionally), it is taunting and should be penalised. For the ball to be "spiked", it must be forcibly thrown into the ground - merely dropping it isn't a foul.
- (d) A celebration should be penalised if it involves:
 - (i) any of the 20+ specific prohibitions in Rule 9-2-1;
 - (ii) the ball;^x
 - (iii) player equipment;
 - (iv) field equipment (including a goal);
 - (v) any object taken from another person;
 - (vi) any prop;
 - (vii) a player going to the ground in a delayed (not immediately after the score) and unnecessary manner.
- (e) An act that isn't on the above list is probably legal, so be tolerant of it, unless you believe it is abusive, threatening or obscene, provokes ill will, or demeans the game. Don't be a prude (one who is excessively concerned with being or appearing to be proper, modest, or righteous; or a person who is easily shocked or offended by things that do not shock or offend other people).
- (f) If an illegal celebration occurs near the goal line, assume that it occurred *after* the score unless an official was in an excellent position to rule on its exact location.
- (g) "Choreographed" means that one or more players have clearly pre-decided, pre-arranged or rehearsed how they will move (as in a dance).

2. Dissent:

- (a) Players play with passion and emotion – coaches share the same traits. At various times, players and coaches can be happy or sad, joyous or disappointed, satisfied or frustrated. These are normal human emotions (officials have them as well), but need self-control.
- (b) Players and coaches are entitled to be disappointed. It is only when it is excessive or challenges an official's authority that it becomes dissent.
- (c) Dissent is when players, coaches or other persons subject to the rules:
 - (i) speak in an abusive, aggressive or denigrating manner to an official;
 - (ii) assert as true something that it is contrary to rule or an official's ruling, or assert as false something that is true;
 - (iii) continue to argue a proposition after being informed that it is incorrect, or asked to stop;
 - (iv) make denigrating comments about an official or a decision while speaking to each other;
 - (v) make gestures (with hands or otherwise) that signify frustration or lack of respect at an official;

- (vi) throw/kick the ball or equipment in disgust;
- (vii) move aggressively towards an official to argue or complain.

Dissent differs from a player or coach asking a genuine question.

- (d) If a player or coach shows the official respect, then the official will show them the same level of respect in return.
- (e) We distinguish between overt dissent and covert dissent. The former is conspicuous, usually because the speech is loud enough for many people to hear, or the gestures are clear and in the open. Covert dissent is where only the official hears it and can be treated slightly differently.
- (f) There are six levels of response to dissent:
 - (i) **Ignore it.** If the dissent is minor, and is the first example of its kind from that player or team, then it *can* be ignored. It might be an isolated incident, never to happen again. However, there is always a risk that ignoring dissent will give encouragement to the participants to repeat it. Ignoring it is certainly not the appropriate response to repeated dissent.
 - (ii) **Pretend you didn't hear it.** Ask the player or coach to repeat their comment ("what did you say?"). If it was inappropriate, they will likely not repeat it. If they do, then there is no doubt that you must respond firmly, professionally and rapidly.
 - (iii) **Quiet word.** A quiet word with a player or coach is often more beneficial than an immediate penalty. It shows your commitment to resolving the issue without recourse to a strict application of the rules of the game.
 - (iv) **Public rebuke.** Sometimes, the player or coach needs to be spoken to loudly enough that their teammates are aware. This may be necessary in order to solicit their help in controlling their emotions.
 - (v) **Penalty.** If dissent is conspicuous to spectators, then it needs to be penalised as unsportsmanlike conduct. Conspicuous dissent includes all actions that involve audible abusive language, thrown equipment, or running towards an official. Verbal dissent also certainly needs to be penalised if it is said a third time (or more).
 - (vi) **Disqualification.** If a player or coach is penalised for dissent twice, then they will be disqualified under Rule 9-2-1. In extreme cases, an act of dissent may be so flagrant as to require immediate disqualification.

There is no need to go through these levels in order. A serious (and conspicuous) act of dissent may require immediate penalty, and possibly even disqualification.

- (g) The following acts by a participant should *always* result in a foul being called:
 - (i) making an aggressive gesture towards an official;
 - (ii) speaking in an abusive, aggressive or denigrating manner to an official that can be heard clearly by spectators;
 - (iii) making "demonstrative disagreement", such as raising hands in incredulity;
 - (iv) smacking themselves to demonstrate how they were fouled;
 - (v) running directly at an official to complain about a call;
 - (vi) making excessive enquiries about a call, even in a civilised tone (as in RA 5.2.f.v above).
- (h) Failing to deal with dissent is letting your colleagues and the sport down. Not only does dissent undermine officials, it can also severely disrupt the atmosphere and flow of a game. If you think you are unconcerned by dissent and ignore it, remember that the same player may make the same comment to a less imperturbable official next week, but that may be the straw that breaks the camel's back and causes that official to quit.
- (i) If you hear dissent directed at another official, *you* deal with it. An important part of officiating teamwork is to back up your colleagues in this way.
- (j) Engage with the captain(s) and coach(es) to make clear it is their responsibility to control their players, to prevent dissent or to stamp it out at first sign. Doing this shows that the official is attempting to work *with* the teams rather than penalise.

- (k) Where appropriate, advise coaches and players to ask genuine questions rather than make assertions about what is true or false.
- (l) If left unchecked, dissent is like a disease that will grow and undermine your authority.
3. **Flagrant unsportsmanlike acts requiring disqualification:** The following acts of unsportsmanlike conduct normally are flagrant and require disqualification:
- (a) Spitting at an opponent or official.
- (b) Any abusive language that involves derogatory reference to an opponent's or official's ethnic origin, colour, race, nationality (except in the context of international competition), religion/belief, sex/gender identity, age, class or social background, political belief, sexual orientation, disability or any other speech intended to demean or brutalize.
- (c) **Participating without being cleared by a healthcare professional after suspicion of a concussion.**
- (d) Any other act of unsportsmanlike conduct which, by its nature or prolonged duration, is extremely objectionable, conspicuous, unnecessary, avoidable or gratuitous.
- (e) Any action specifically directed at one or more officials, officials assistants or spectators is generally more extreme than the same action directed at an opponent.
4. **Multiple fouls:**
- (a) Do not penalise a player or team twice for the same unsportsmanlike act.
- (b) However, where there are multiple, distinct acts by the same player or by different players, it is appropriate to penalise them separately. Two unsportsmanlike acts by the same player will result in them disqualifying themselves.
- (c) Examples of separate acts include:
- (i) a prohibited celebration followed by dissent at an official's call;
- (ii) taunting an opponent followed by bowing to spectators;
- (iii) shoving after the ball is dead followed by removing a helmet;
- (iv) a prohibited celebration followed by one or more substitutes entering the field to join the celebration;
- (v) **anyone** reacting in an unsportsmanlike manner following being informed of the circumstances of a prior foul;
- (vi) **walking away after an unsportsmanlike act, but then returning to commit another unsportsmanlike act.**
- (d) Examples of acts that normally would NOT be regarded as separate include:
- (i) more than one player participating in a delayed, excessive, prolonged or choreographed celebration;
- (ii) a player taunting more than one opponent;
- (iii) a player bowing in more than one direction;
- (iv) a player making one unsportsmanlike comment or gesture and then **a similar** one a few seconds later.
5. **Other points regarding unsportsmanlike conduct:**
- (a) **Live or dead:** If in doubt whether an unsportsmanlike conduct foul occurred while the ball was live or dead, it was dead.
- (b) **Who to penalise:** Do not penalise the conduct of anyone other than a player or coach. If someone else is giving you a problem, ask the team or game management to deal with it.
- (c) **Simulating being roughed:** Normally a kicker who simulates being roughed should be ignored. A penalty should only be administered if necessary to exert proper game control.
- (d) **Simulating other fouls:** **A player attempting to draw a foul by an opponent by conspicuously simulating a reaction to mild or non-existent physical contact has committed unsportsmanlike conduct.**

- (e) **Removing helmets on the field:** Players who unthinkingly remove their helmets on the field of play should not be penalised unless they are (i) directing anger or criticism at an opponent or an official; or (ii) celebrating. Remind them to keep their helmets on. A player removing their helmet in the vicinity of the sideline just prior to entering the team area should be ignored.
- (f) **If you observe a coach signalling to an obviously uninjured player to go down, this is one unsportsmanlike conduct penalty for feigning an injury, but both the player and the coach will have the penalty counted against them for the purposes of Rule 9-2-6-a.**
- (g) **Unusual technical fouls:** When a participant inadvertently breaches an unusual rule (e.g. Rule 1-4-10), a first offence can usually be dealt with by a warning and an immediate requirement to rectify the breach. A penalty is only necessary when the breach has been intentional. **(Warn for first offence and penalise second and subsequent.)**

6. Sideline interference:

- (a) While the ball is dead:
 - (i) Provided participants in the team area respond reasonably promptly to requests to get back from the sideline, there is no need to warn or penalise them, no matter how many times it happens.
 - (ii) Give a sideline interference foul (Rule 9-2-5) only if a head coach repeatedly (i.e. more than once) ignores requests (made while the ball is dead) to keep their team back from the sideline while the ball is alive or in continuing action after it is dead.
- (b) While the ball is in play:
 - (i) Coaches, substitutes and other non-players *on* the field should always be flagged for sideline interference (Rule 9-2-5). An exception is not to be too bothered if the ball is near Team B's goal line and the personnel are still near their team area.
 - (ii) If they are *between* the sideline and the coaching box line, use your discretion and issue a verbal warning if they did not actually cause any problem.
 - (iii) Any contact between an official and a team member on the field or between the sideline and the coaching box line should be called as a team unsportsmanlike act (Rule 9-2-5-b) (with normally a 15-yard penalty from the succeeding spot) even for a first offence. This also applies if there is no physical contact but the official is forced to change direction either to avoid contact or to maintain their view of what they are observing.

7. Fighting:

- (a) Three rules talk about "striking" an opponent: how do you decide which to call?
 - (i) Personal foul (Rule 9-1-2-a): Normally use this for action that occurs while the ball is live. Unless the action could cause catastrophic injury, don't regard it as flagrant.
 - (ii) Unsportsmanlike conduct (Rule 9-2-1-a-1-j): Normally use this for action that occurs in the aftermath of a play.
 - (iii) Fighting (Rules 2-32-1 and 9-5-1): Normally reserve this for more serious, more severe, more prolonged action. It is unlikely that a single strike constitutes a fight.
- (b) If action is deemed to be "fighting" then the player must be disqualified. It is *not* fighting if players are merely pushing each other (i.e. no deliberate punches, kicks or blows are struck or aimed). If in doubt, it is *not* fighting.
- (c) **Disqualify a player for punching only when the act appears to be malicious. Consider factors such as the level of intent, the force of the blow, the duration of the incident and whether it is a first offence. Minor, frustration-driven contact may be treated as an unsportsmanlike act, unless one or more of these factors applies.**
 - (i) **We have seen players disqualified for fighting because an official saw them "throw a punch". When evaluating the video of those incidents, it is almost always the case that what the official interprets as a punch is a failed attempt by a tackler to grasp an opponent or force a fumble - movements are rapid and jerky but don't always lock onto their target.**

- (ii) Why would a player throw a punch during live ball action? A punch is not going to land a blow on the opponent's head because of their helmet. It is not likely to land a blow on the opponent's upper torso because of their pads. It might land a blow if it was precisely into the solar plexus, but that is also near where ball carriers carry the ball and therefore a legitimate target for forcing a fumble.
 - (iii) If you clearly saw a defensive lineman (for instance) thrust their closed fist(s) into an offensive lineman's stomach area, you might regard that as a personal foul, but only if you clearly saw closed fists - open or partially-open hands would be an indicator that this was not intended as foul play.
 - (iv) Striking an opponent is most likely to be done out of frustration at being held or taunted. This is usually best dealt with as unsportsmanlike conduct, unless it is prolonged (i.e. there are several blows) at which point it becomes a fight.
 - (v) However, where a punch is not an immediate act of frustration, it may justify disqualification. This is more likely when the action has at least one of the following characteristics: delayed, calculated, very forceful, contemptuous, repeated.
 - (vi) If in doubt as to whether a player has intentionally elbowed an opponent, look at the player's hand. It is a natural reaction to make a fist before striking with the elbow. An open hand probably indicates unintentional contact.
 - (vii) Similarly, punches based on frustration tend to have a "wind up" where the puncher pulls their arm/elbow back before striking. Short-arm jabs are possible, but less likely to inflict a major blow.
- (d) During a fight, try to distinguish between those players (on the field at the start of the fight), substitutes and coaches who actively participate in a fight and those who are trying only to separate the combatants. The latter should not be disqualified.
 - (e) Only disqualify a player if you are certain of their number. If two opposing players are fighting with each other, don't disqualify one unless you know the identity of the other.
 - (f) Unnecessary roughness when Team B has no chance to win and Team A has clearly indicated its intention to "take a knee" should normally result in disqualification of the player committing the foul.

8. Retaliation:

- (a) For the purposes of this section, we define retaliation as when a player commits an aggressive act in direct response to an aggressive act by an opponent on themselves or a teammate. Retaliation may be by physical contact or by unsportsmanlike word or deed. Retaliation normally occurs within a few seconds of the original act, but could in theory be delayed.
- (b) Normally, we want to impose the most severe punishment on the participant who started the incident (the "instigator"). The "punishment" in this context, may be a warning (for a minor infringement), a penalty (for a significant infringement) or disqualification (for a serious infringement).
- (c) If the retaliation is of less seriousness than the original act, the retaliator should normally receive a lesser punishment than the instigator. For example, if A31 commits an unnecessary roughness foul on B45, and B45 retaliates by (a) pushing A31 away; or (b) swearing at A31, then in both cases we would likely not penalise B45, but simply warn them. This would also apply if A31 spat on B45 (a mandatory disqualification according to RA 5.3) and B45 retaliated by pushing A31. A31 would be disqualified, but B45 may only be penalised or warned.
- (d) However, if the retaliation prolongs or escalates the incident by being as (or more) severe than the original act, then normally the retaliator should receive the same or a higher punishment than the instigator. For example, if B45 responds by (a) committing an equally unnecessary act of roughness on A31; or (b) starting a fight with A31, then both would be severely penalised. In the case of a fight, Rules 2-32-1 and 9-5-1 together mandate disqualification of both players.

- (e) In any case where retaliation is delayed (to the next play or later) and deliberate, disqualification of the retaliator alone is normally required. This includes cases where the retaliator is a teammate of the player who was the victim of the original attack.
9. **Pre-game:** During the pre-game warmups and during the coin toss ceremony, penalise acts by anyone subject to the rules that are designed to provoke their opponents.
- (a) This includes conspicuous acts such as choreographed action (e.g. a haka), flag planting, waving a team's flag at an opponent or its supporters, or any similar action (or simulation of these).
- (b) Taunting an opponent and other non-conspicuous acts should also be penalised.
- (c) If you can see signs of the build up to one of these provocations, step in and try to persuade the player(s) to stop. Penalise if they do not do so.
10. Apply a zero tolerance policy to acts of unsportsmanlike conduct and fighting in junior/youth football.
11. Approved Ruling 9-2-6:II defines which fouls count towards disqualification under Rule 9-2-6-a.

RA 6 – Fouls that always involve advantage

The fouls that previously appeared in this section have been moved to Section RA 3 (Contact fouls) or Section RA 4 (Non-contact fouls) as appropriate. [×]

RA 7 – Catches and fumbles

1. If the ball moves from the control of one player to another (whether teammate or opponent) during the act of gaining possession, the ball belongs to the player in final control (provided they had control inbounds). This is not a simultaneous possession. If the last player in control did not have control inbounds, or any player was out of bounds at the same time as they touched the ball, the ball is loose out of bounds. If in doubt as to whether a player had control inbounds, they did not.
2. If the receiver gets their toe inbounds but their heel or ankle comes down a fraction later out of bounds (or vice versa) then the pass is incomplete. If the whole foot touches the ground, it all has to be inbounds for the catch to be completed. **Similarly, the fingers, palm and wrist are all regarded as part of the hand.** This principle does not extend to the foot and leg/knee, nor to the hand and arm/elbow – these are regarded as separate parts of the body and only the first contact with the ground is relevant.
3. It is not a fumble if the ball is stripped after the ball carrier has been driven back. The ball is dead once the ball carrier is so held that their forward progress is stopped.
4. A player has the ball long enough to become a ball carrier when, after their foot is on the ground, they do one of the following (sometimes known as "acts common to the game") (Rule 2-4-3):
 - (a) avoiding or warding off impending contact by an opponent;
 - (b) tucking the ball away;
 - (c) advancing the ball (or retreating with it); or extending it towards the goal line or line to gain;
 - (d) taking additional steps while upright (i.e. not while falling to the ground);
 - (e) passing the ball or handing it off.
5. Do not try to be too technical on ruling a catch. We do not want officials who try to have "the greatest eyes in the history of the game" and rule too many times the receiver has completed the process of the catch and fumbled the ball when it should be an incomplete pass. The most important principle is "when in doubt, incomplete".
6. We use exactly the same approach whether the catch is in the end zone or in the field of play.
7. In ruling whether a Team A player has passed or fumbled the ball, bear in mind the following:
 - (a) Any action by the player's hand moving forward and the ball coming out should be ruled a forward pass.

- (b) If the player is able to see the defender approaching, they are likely to be able to move their hand or arm forward before they are contacted. When they do not see the hit coming, the chances are greater that a fumble occurred.
 - (c) After the player was hit, if the ball lands behind them it is more likely that a fumble occurred.
8. Checklist for possession (adapted from Dean Blandino presentation, 2021):
- (a) Is control established with hand(s) or arm(s)? Was control established before the ball touches the ground (catch only)? Slight movement is not a loss of control but a bobble, juggle, bounce or the hands coming off the ball would be.
 - (b) Establish which body part touched the ground (or pylon) first. Was it completely in bounds?
 - (c) How long did the player have control of the ball?
 - (i) If upright, when did they transition from receiver to ball carrier? Did they have the ability to ward off or avoid an opponent? Did they tuck the ball away, turn upfield and/or take additional steps? Did they extend the ball for additional yardage (goal line or line to gain)?
 - (ii) If going to ground, did they maintain control when they touched the ground? Or, did they perform an act common to the game (e.g. extending for additional yardage) on their way to the ground?

RA 8 – Other rules applications

1. Fair catch signals:

- (a) Don't be picky about fair catch signals. Any waving signal or raising a single arm above the head is sufficient to indicate that a fair catch has been called for.
- (b) Players obviously shading their eyes from the sun have *not* signalled for a fair catch.
- (c) Any "get away" or "T" signal before or after the ball touches the ground is an invalid fair catch signal. A "T" signal is when a player stretches their arms out, similar to an official's matching substitutes signal (Sup36).
- (d) A receiver who points at the ball and keeps their hands below their shoulders with no waving motion has made no signal and can advance the ball. A receiver who keeps their hands below their shoulders and has a waving motion, or one who has their hands just above the shoulders with no waving motion, has made an invalid signal.

2. Poor field markings:

- (a) **Onside kick:** If in doubt on a poorly marked field, the chain can be used following a free kick to measure whether a spot of first touching is illegal or not.
- (b) **Incorrect inbounds lines:** Sometimes a field is marked with inbounds lines at the wrong distance from the sideline (e.g. the NFL distance of 70ft 9in instead of the correct 60ft). If this is the case, to ensure the integrity of the game, do not play to the marked inbounds lines - use cones or other indicators behind the end lines to approximate the line of the inbounds lines, and spot the ball between them.

3. Spotting the ball:

- (a) **Spotting the ball for a new series:** The ball should be placed nose-on to a yard line after a change of possession. For example, if a return ends with the ball between the B-28 and B-29, move the ball to the B-29. The exception is the ball should not be moved if, inside Team B's three-yard line, a kick is downed on the ground or a fourth-down run/pass play ends.
- (b) **Change of possession close to goal line:** If an interception, kick catch or recovery is made inside the one-yard line and immediately carried into the end zone, try to make the play a touch-back rather than a momentum exception. Where Team A illegally touches a kick near the goal line, try to rule the touching as being in the end zone, particularly if they carry the ball into the end zone.
- (c) **Ball coming out of end zone:** If there is a change of possession in the end zone (or the momentum exception rule applies), when in doubt during the return the ball has NOT left the end zone.

- (d) **Ready for play:** The ball can never be ready for play if an official has not at least touched it at the succeeding spot. If a player spots the ball themselves, and they get the ball in the correct position, an official still needs to touch it and get into position to officiate before the ball becomes ready for play (Rules 2-2-4 and 4-1-4).

4. **Timing:**

(a) **Timing in the last few seconds of a period:**

- (i) One second can be enough to make the ball live. If the clock starts on the ready, the Referee should wait until Team A is set before declaring the ball ready.
- (ii) Two seconds are not long enough for the ball to become live and then dead again **before time expires** (Rule 3-2-5).
- (iii) With five seconds or less remaining when the ball is snapped, a normal field goal attempt will end the period.

- (b) **Timing on free kicks:** No time will run off the clock if a free kick is recovered cleanly by a player who is on the ground or has signalled for a fair catch. At least one second will run off if they muff the ball and then catch or recover it.

- (c) **Timeouts and flags:** When in doubt, a charged team timeout preceded (and may thus cancel) a 5-yard penalty foul that prevented the snap.

- (d) **Timeouts and injuries:** If a team calls a timeout, but before the Referee makes the announcement, the other team is discovered to have an injured player, give the first team their timeout back. If one team calls a timeout right after the end of the play and at the same time an injured player is discovered, give them the timeout back unless they choose to still take it. Remember that a timeout cannot be used to allow an *injured* player to stay in the game, though it can be used for a player whose helmet has come off (Rules 3-3-6-a-1 and 3-3-10-a).

- (e) **Coach requesting a timeout:** Officials should not be distracted from their game duties by the possibility that a head coach may request a timeout.

- (i) When a snap or free kick is imminent (i.e. when Team A is in its formation), wing officials must not turn their eyes away from the field of play. In these circumstances, the head coach may need to attract the attention of one of the officials in the middle of the field (referee, umpire, back judge), or even the wing official on the opposite sideline, who is facing them. A "T" hand signal (like signal Sup45) *and* verbalising the word "timeout" are both necessary under these circumstances.

- (ii) When the ball is dead and there is no threat of action on the field, a verbal request to the nearest official will be sufficient.

- (iii) Under no circumstances shall an official stop the clock unless they are certain that the request comes from the *head* coach. If the official is unsure whose voice requested the timeout, and is unable to turn round to find out, no timeout will be granted.

- (iv) Before the snap, anticipate a coach asking for a timeout when you know their team is a player short or looking confused. At the end of a play, anticipate a coach or player asking for a timeout when the game clock is running and their team wants to conserve time.

- (f) **Coaches on the field during timeout:** During a charged timeout, coaches who come on to the field less than 9 yards from the sideline and do not go beyond the 20-yard lines are not normally to be regarded as a problem unless their behaviour draws attention to themselves.

5. **Trick plays:** Be very strict in penalising trick plays that constitute unfair tactics. Such plays include (but are not limited to):

- (a) trick plays depending on the ball being concealed or substituted (Rule 9-2-2-a);
- (b) trick plays associated with simulated substitutions, **particularly "hiding" a player near the sideline on their team's side of the field** (Rule 9-2-2-b);
- (c) trick plays involving players' equipment (Rule 9-2-2-c);

- (d) trick plays where Team A runs a "normal" play having informed the opponents that it would be "taking a knee" (see also RA8.6.c below) (Rule 9-2-2-d);
- (e) trick plays with actions or verbiage designed to confuse the defense into believing the snap or free kick is not imminent (Rule 9-2-2-d) – this includes pretending to have a problem with the play that has been called, an equipment problem with a shoe, the ball, etc. and feigning an injury (Rule 9-2-2-e); it also includes assuming the role or functions of an official.

Rules of thumb:

- (i) If an unusual act appears to be unfair, it is probably contrary to the rules.
 - (ii) Relevant to simulated substitutions is to ask yourself, "Could the team have equally well run that play on the other side of the field?". If the "simulated" replaced player was moving towards their own team area, this is more suspicious than if they were moving towards their opponent's team area.
6. **Take a knee plays:** When Team A informs the officials that they intend to "take a knee" (sometimes known as the "victory formation"):
- (a) Ensure that Team B is informed.
 - (b) Remind Team A that Team B will still be able to stop the clock if they have timeouts remaining.
 - (c) Remind Team A that they will be penalised (under Rule 9-2-2-d) if they subsequently run a "normal" play after having declared their intention to "take a knee" (see also RA 8.5.d above). This includes not taking a knee immediately (**less than 3 seconds**) after controlling the snap.
 - (d) Remind Team B of Team A's declared intention on each subsequent play, unless Team A informs you that they will run a normal play, in which case inform Team B of that.
 - (e) Warn Team B not to "punish" opponents or otherwise attempt to interfere with the process (other than in a legitimate attempt to gain possession of a loose ball).
 - (f) **All officials may choose to change their initial position for the snap. By "pinching in" closer to their nearest player(s), they may be in better position to deter, prevent or de-escalate any aggressive actions.**
 - (g) Penalise players from either team who try to take advantage of the situation to either gain yards (Team A) or punish an opponent (Team B normally). If Team A consumes time unfairly, Rule 3-4-3 may be used to restore time to the game clock.
 - (h) If the score is close, then Team B has a legitimate right to attempt to gain possession. However, if the margin in the score is wider than could reasonably be overcome in the time available, Team B should not instigate any forcible contact.
 - (i) If Team A line up in a "victory formation" but do not inform the officials or Team B that they intend to take a knee, this guidance does not apply and Team A may equally legally run a "normal" play or take a knee (at their risk).

7. Inadvertent whistle:

- (a) The overall philosophy for the rules on inadvertent whistles (and their application) is to reset the state of the game as closely as possible to what it would have been had the inadvertent whistle not been blown. Also, part of our philosophy is that we do not want what is an officiating mistake to cancel out either a piece of exceptionally good or exceptionally bad play by one or more players, whenever possible. An inadvertent whistle should be as inconsequential as possible.
- (b) When an inadvertent whistle occurs just before the ball would anyway have become dead, the exceptions in Rule 4-1-2-b provide effective mechanisms by which the next play would be the same (or close to) what it would have been had the whistle not been blown. This is also the case when a foul has occurred (Rule 4-1-2-c).

- (c) When an inadvertent whistle is followed by a dead-ball situation not explicitly covered by an exception in Rule 4-1-2-b, if there is a plausible opportunity to apply one of the parts of Rule 4-1-3 (for example, Rule 4-1-3-s) in preference to Rule 4-1-2-b, do so. That will minimise the consequences of the inadvertent whistle, perhaps to zero.
- (d) When an inadvertent whistle occurs early or in the middle of the intended play, the fairest outcome is usually applying the relevant section of Rule 4-1-2-b that leads to the option of the down being repeated (unless the dead-ball spot is advantageous to the team in possession).

(e) **Continuing action:** After an inadvertent whistle, if one or more players in the vicinity of the ball continue to play the ball, regardless of the time, then that is the immediate continuing action. This period stretches as long as those players in the vicinity continue to play the ball, regardless of what other players do on the field.

8. **Dealing with disqualifications:** A disqualified participant must leave the playing enclosure (Rule 9-2-6-b) within a reasonable amount of time. Provided they are making progress towards leaving at a reasonable rate, the game should continue. However, the game may need to be suspended if the disqualified participant attracts attention or delays their departure. The offending team is responsible for escorting their participant away and may be penalised (for delay of game) if this is not achieved. If the disqualified participant or the person(s) responsible for them commits a (possibly further) unsportsmanlike act, this should be penalised.

RA 9 – When in doubt principles

If you are reasonably sure of something, then go with that – it is more likely to be correct than to fall back on the relevant "when in doubt" principle. However, the "when in doubt" principles reflect experience that, in certain situations, one outcome is more common than the other. Therefore, by going with the more common outcome, you are more likely to be correct, but that is not guaranteed. The principles are not there to excuse failing to apply the correct mechanics.

Note that the principles below do *not* change when video review is available. Given the quality of video we will most often see, it is likely that many reviews will let "stand" the call on the field, so it is important to make the call on the field as fair as possible.

When in doubt:

Pre-snap

1. offensive players are legally on the line;
2. offensive players are legally in the backfield;
3. defensive signals are legal;
4. a departing player has left the field prior to the snap;
5. a charged team timeout precedes a foul that prevents the snap;
6. the one second pause after a shift has been violated;
7. players are legally moving rather than in illegal motion;
8. it is a false start rather than illegal motion;
9. an eligible receiver is not covered up on the line of scrimmage;
10. when a Team B player moves into the neutral zone before the snap and causes a Team A player to react, the movement *is* towards the Team A player;
11. when a Team B player aligned right to the line of scrimmage jumps forward and causes a Team A player to react, the Team B player *was* in the neutral zone and is the one penalised;
12. when a Team B player shoots the gap between Team A linemen, there *was* contact causing an off-side foul;
13. a quick or abrupt movement by the snapper or quarterback is a false start;

Blocking

14. the back at the snap is not positioned outside the normal tackle;
15. as to disintegration of the free-blocking zone (Rule 2-3-6) or tackle box (Rule 2-34), they are intact;
16. a block below the waist occurred before (not after) the ball left the tackle box
17. it is a legal block rather than clipping;
18. the contact is below the waist rather than above it (Rule 2-3-2);
19. a blind-side block is legal rather than illegal;
20. as to a block in the back, the contact is at or below the waist rather than above (Rule 2-3-4-a);
21. it is legal use of hands rather than holding or illegal use of hands;

Passing

22. the forward pass is incomplete rather than a fumble;
23. the forward pass is catchable (Rule 2-19-4);
24. it is a fumble rather than a forward pass if the passer was hit from their blind-side, or if you see an empty hand moving forward, otherwise the passer has thrown the ball rather than fumbled it (Rule 2-19-2-c);
25. the passer has not intentionally grounded the ball;
26. the pass is forward rather than backward behind the neutral zone (Rule 2-19-2-a);
27. the pass is backward rather than forward beyond the neutral zone or when there is no neutral zone;
28. the forward pass was thrown or forward hand-off made from in or behind rather than beyond the neutral zone;
29. the forward passer is (or has been) outside the tackle box;

Possession and touching

30. a catch, recovery or interception is not completed (Rule 2-4-3-h);
31. as to whether the ball touched the ground during a catch, it did not touch the ground;
32. on a simultaneous catch or recovery, whoever comes up with the ball gets it;
33. it is a fumble rather than the running play has ended;
34. as to touching the ball, a player has not touched it (Rule 2-11-4);
35. the ball is accidentally touched rather than intentionally batted or kicked (Rules 2-11-3, 2-16-1-a and 2-16-1-d);

Kicks

36. with respect to kick-catch interference, a kicking team member has (a) entered the area in front of the receiver; (b) contacted the potential receiver before (or simultaneous with) their first touching the ball; (c) interfered with a receiver in position to catch the kick and who does not do so;
37. if it occurs close to the time of the kick, a foul by a Team B player trying to get to the kicker will have previous spot enforcement; a foul by a Team B player trying to aid the return will have postscrimmage kick enforcement;
38. a foul by Team B on a scrimmage kick occurred after (not before) the ball was kicked;
39. the kicker is outside the tackle box;
40. it is not a scrimmage kick formation;
41. a kicking team player has not broken the plane of their restraining line;

Ball live/dead

42. the ball is dead (Rule 4-1-3-a);
43. the player is in bounds rather than out of bounds;
44. if the ball carrier is being held by only one player, the ball is still alive; if held by two or more, forward progress is stopped;

45. an unsportsmanlike conduct foul occurred while the ball was dead rather than live;

46. the ball was dead rather than the whistle was inadvertent;

Contact and fouls

47. a player is defenseless (Rule 2-27-14);

48. the defensive back has legally initiated contact in passing situations;

49. the face mask, chin strap or helmet opening has been grasped then twisted, turned or pulled (Rule 9-1-8-b);

50. the foul is roughing rather than running into the kicker (Rule 9-1-16-a-8);

Near the end zone

51. it is a touchback rather than a safety (Rule 8-5-1-a);

52. it is a touchback rather than a momentum exception;

53. the ball is dead in the field of play rather than a touchdown;

54. as to whether an illegal block or other illegal act occurs in the end zone or field of play, it occurs in the field of play;

55. on changes of possession in or near the end zone, the return has NOT left the end zone;

56. Team B caught or recovered the kick in its own end zone rather than in the field of play;

57. the kick was touched in Team B's end zone rather than in the field of play;

58. if there is a change of possession in the end zone (or the momentum exception rule applies), during the return the ball has not left the end zone;

Miscellaneous

59. call timeout for injured players;

60. an injury was observed before the ball was spotted;

61. the Referee should invoke Rule 3-4-3 (unfair clock tactics) when the game clock is under 5 minutes of each half;

62. there is no foul;

63. don't throw the flag;

64. don't blow the whistle.

Index of Rules and Interpretations

- 10-second Runoff from Game Clock — Common Procedures (Delays/Clock Tactics) 67
- 10-second Runoff from Game Clock – Foul (Delays/Clock Tactics) 66
- 10-second Runoff Summary (Delays/Clock Tactics) 67
- Accessibility (Players and Playing Equipment) 28
- Administration and Enforcement (The Ball) 19
- After the Ball is Snapped (Backward Pass and Fumble) 102
- All Become Eligible (Scrimmage Kicks) 88
- Approved Rulings and Official’s Signals 29
- At Rest (Backward Pass and Fumble) 102
- Ball coming out of end zone 208
- Ball Dead in End Zone (Free Kicks) 85
- Ball Declared Dead (Ball in Play – Dead Ball) 73
- Ball Ready for Play (Ball in Play – Dead Ball) 75
- Basic Spot (Spots) 42
- Batting a Backward Pass in Flight (Batting and Kicking) 141
- Batting a Loose Ball (Batting and Kicking) 140
- Batting Ball in Possession (Batting and Kicking) 141
- Batting (Fumble, Muff; Batting and Touching the Ball; Blocking a Kick) 34
- Behind the Neutral Zone (Scrimmage Kicks) 87
- Belongs To (Catch, Recovery, Possession) 31
- Below Waist (Blocking) 30
- Between Downs (Down, Between Downs and Loss of Down) 32
- Beyond the Neutral Zone (Scrimmage Kicks) 87
- Blind-side block (Blocking) 30
- Blind-side block fouls 196
- Blind-side block (Personal Fouls) 130
- Blocking a Scrimmage Kick (Fumble, Muff; Batting and Touching the Ball; Blocking a Kick) 35
- Blocking Below the Waist (Personal Fouls) 123
- Blocking (Blocking) 29
- Blocking in the Back (Blocking, Use of Hands or Arms) 140
- Block in the Back (Blocking) 30
- Boundary Lines (Lines) 35
- Catchable Forward Pass (Passes) 39
- Catch, Interception, Recovery (Catch, Recovery, Possession) 31
- Catch or Recovery by Kicking Team (Scrimmage Kicks) 88
- Catch or Recovery by Receiving Team (Scrimmage Kicks) 88
- Caught or Recovered (Backward Pass and Fumble) 101
- Celebrations 202, 205
- Chain 208
- Charged Team Timeouts (Timeouts: Starting and Stopping the Clock) 59
- Chop Block (Blocking) 30
- Chop block fouls 196
- Chop Blocking (Personal Fouls) 127
- Clipping 32
- Clipping fouls 191, 212

- Clipping (Personal Fouls) 123
Clotheslining 190
Coaches' Certification (Players and Playing Equipment) 26
Coaches' Phones, Headsets and Communication Devices (Players and Playing Equipment) 27
Coach (Team and Player Designations) 45
Complete Pass (Forward Pass) 105
Conspicuous actions 189
Contact Against an Opponent Out of the Play (Personal Fouls) 128
Contact Against the Snapper (Personal Fouls) 128
Contacting an Official (Unsportsmanlike Conduct Fouls) 136
Continued Participation Without Helmet (Personal Fouls) 130
Continuity of Downs Broken (A Series: Started, Broken, Renewed) 79
Criteria for reversing an on-field ruling (Procedures) 155
Crosses Neutral Zone (Passes) 39
Dead Ball Becomes Alive (Ball in Play – Dead Ball) 72
Dead-Ball Fouls (Penalties Completed) 144
Dead-Ball Spot (Spots) 41
Dead Ball (The Ball: Live, Dead, Loose, Ready For Play) 29
Dead Where Caught (Fair Catch) 93
Defenseless player 195
Defenseless player (Team and Player Designations) 44
Defensive Linemen on Scrimmage Kick Plays (Scrimmage Kicks) 91
Defensive pass interference fouls 193
Defensive Team Requirements (The Scrimmage) 100
Delaying the Start of a Half (Delays/Clock Tactics) 64
Delay of game fouls 197
Determining the Enforcement Spot and the Basic Spot (Enforcement Procedures) 145
Dimensions and Markings (The Field) 14
Disconcerting signals fouls 199
Disqualified players and coaches (Unsportsmanlike Conduct Fouls) 136
Disqualified Player (Team and Player Designations) 44
Disqualifying foul 195, 197
Dissent 202
Down (Down, Between Downs and Loss of Down) 32
Drop Kick (Kicks; Kicking the Ball) 36
During Live Ball (Backward Pass and Fumble) 101
Eligibility Gained or Regained (Forward Pass) 105
Eligibility Lost by Going Out of Bounds (Forward Pass) 105
Eligibility to Block (Free Kicks) 86
Eligibility to Touch Legal Forward Pass (Forward Pass) 104
Eligible receiver 197
Encroachment (Encroachment and Offside) 38
Encroachment foul 199
End Lines (Lines) 35
End Zones (Field Areas) 46
Enforcement Spots (Enforcement Procedures) 145
Enforcement Spot (Spots) 41
Entities Subject to the Rules (General Provisions) 14
Equipment and personnel (Procedures) 154
Explicitly reviewable fouls (Scope of instant replay) 153

- Extension of Periods (Playing Time and Intermissions) 52
- Extra Periods (Start of Each Period) 49
- Face mask fouls 195
- Failure to wear mandatory equipment 200
- Fair Catch (Fair Catch) 32
- Fair catch signal 197, 208
- False start fouls 189, 198
- Field Goal Attempt (Kicks; Kicking the Ball) 37
- Field markings 208
- Field of Play (Field Areas) 46
- Field Surface (The Field) 18
- Fighting 142, 47
- Fighting fouls 205
- Flagrant Personal Foul (Foul and Violation) 34
- Flagrant Personal Fouls (Personal Fouls) 121
- Flagrant unsportsmanlike conduct 204
- Forced Touching Disregarded (Free Kicks) 84
- Forced Touching Disregarded (Scrimmage Kicks) 88
- Forfeited Games (Value of Scores) 112
- Forward and Backward Pass (Passes) 39
- Forward, Beyond (Forward, Beyond and Forward Progress) 33
- Forward passer (Team and Player Designations) 43
- Forward Pass Play (Play Classification) 45
- Forward Progress (A Series: Started, Broken, Renewed) 78
- Forward Progress (Forward, Beyond and Forward Progress) 33
- Foul After Change of Team Possession (Down and Possession After a Penalty) 80
- Foul Against Kicker (Free Kicks) 85
- Foul Before Change of Team Possession (Down and Possession After a Penalty) 80
- Foul Between Downs (Down and Possession After a Penalty) 80
- Foul Between Series (Down and Possession After a Penalty) 80
- Foul During Free Kick Down (Down and Possession After a Penalty) 79
- Foul (Foul and Violation) 33
- Foul Not Called (Flagrant Fouls) 142
- Fouls After a Try (Try Down) 116
- Fouls by Both Teams (Down and Possession After a Penalty) 81
- Fouls By Kicking Team (Free Kicks) 85
- Fouls By Kicking Team (Scrimmage Kicks) 90
- Fouls by Team A During Kicks (Enforcement Procedures) 148
- Fouls During a Try After a Change of Team Possession (Try Down) 116
- Fouls During a Try Before a Change of Team Possession (Try Down) 115
- Fouls During or After a Touchdown, Field Goal or Try (Enforcement Procedures) 148
- Frame of the body (Blocking) 30
- Free-blocking zone (Blocking) 30
- Free Kick at Rest (Free Kicks) 84
- Free Kick Caught or Recovered (Free Kicks) 85
- Free Kick Formation (Free Kicks) 82
- Free Kick (Kicks; Kicking the Ball) 37
- Free kick out of bounds fouls 189
- Free Kick Play (Play Classification) 45
- Fumble (Fumble, Muff; Batting and Touching the Ball; Blocking a Kick) 34

- Game Administration and Sideline Interference (Unsportsmanlike Conduct Fouls) 136
- Game Clock (Timing Devices) 45
- Game Officials (General Provisions) 13
- Goal Lines and Pylons (Lines) 35
- Goal Lines (General Provisions) 13
- Goals (The Field) 16
- Half-Distance Enforcement Procedures (Enforcement Procedures) 150
- Handing the Ball 36
- Handing the Ball Forward (The Scrimmage) 101
- Hash Marks (Lines) 35
- Held Ball Out of Bounds (Out of Bounds) 76
- Helmet and Face Mask Fouls (Personal Fouls) 126
- Helmet Comes Off – Timeout (Timeouts: Starting and Stopping the Clock) 63
- Holding and Use of Hands or Arms: Defense (Blocking, Use of Hands or Arms) 139
- Holding and Use of Hands or Arms: Offense (Blocking, Use of Hands or Arms) 138
- Holding fouls 189, 190, 212
- Horse collar tackle fouls 196
- Horse-Collar Tackle (Personal Fouls) 128
- How and When Completed (Penalties Completed) 143
- How Scored (Field Goal) 116
- How Scored (Safety) 117
- How Scored (Touchdown) 112
- How Scored (Try Down) 113
- Hurdling 36
- Hurdling (Personal Fouls) 128
- Illegal block below the waist fouls 191
- Illegal block in the back fouls 191, 212
- Illegal Block or Contact (Fair Catch) 95
- Illegal Contact and Pass Interference (Forward Pass) 107
- Illegal Delay of the Game (Delays/Clock Tactics) 64
- Illegal equipment (Players and Playing Equipment) 24
- Illegal equipment violations 201
- Illegal formation 197
- Illegal formation fouls 197
- Illegal forward handing fouls 201
- Illegal Forward Pass (Forward Pass) 103
- Illegally Kicking a Ball (Batting and Kicking) 141
- Illegal motion fouls 199, 211
- Illegal substitution fouls 189, 200
- Illegal Touching (Forward Pass) 111
- Illegal touching fouls 189, 200
- Illegal use of hands fouls 191, 212
- Illegal Wedge Formation (Free Kicks) 85
- Illegal wedge fouls 201
- Inbounds Spot (Spots) 41
- Incomplete Pass (Forward Pass) 107
- Ineligible receiver 197
- Ineligible Receiver Downfield (Forward Pass) 110
- Ineligible receiver downfield fouls 199
- Information provision (Procedures) 155

- Initial Impetus (Responsibility and Impetus) 120
- Initiating review (Procedures) 155
- Injured players (Scope of instant replay) 154
- Injury Timeout (Timeouts: Starting and Stopping the Clock) 60
- Intentional grounding fouls 200
- Interference with Opportunity (Opportunity to Catch a Kick) 92
- Interfering for or Helping the Ball Carrier or Passer (Blocking, Use of Hands or Arms) 137
- Interval Fouls (Penalties Completed) 145
- Invalid Signal (Fair Catch) 33
- Invalid Signals: Catch or Recovery (Fair Catch) 94
- Jersey Design, Colour and Numerals (Players and Playing Equipment) 22
- Junior players 188
- Jurisdiction 151
- Kick After Safety (Safety) 119
- Kick-catch interference fouls 196
- Kicker and Holder (Team and Player Designations) 42
- Kicking Team (Free Kick Out of Bounds) 86
- Kicking the Ball; Legal and Illegal Kicks (Kicks; Kicking the Ball) 36
- Kickoff (Kicks; Kicking the Ball) 37
- Late Hit, Action Out of Bounds (Personal Fouls) 125
- Late hit fouls 194
- Legal and Illegal Kicks (Scrimmage Kicks) 89
- Legal Forward Pass (Forward Pass) 102
- Legal Substitutions (Substitutions) 67
- Length of Periods and Intermissions (Playing Time and Intermissions) 51
- Length of Timeouts (Timeouts: Starting and Stopping the Clock) 62
- Leverage and Leaping (Personal Fouls) 127
- Limit Lines (The Field) 15
- Lineman and Back (Team and Player Designations) 43
- Line-to-Gain and Down Indicators (The Field) 18
- Line to Gain (A Series: Started, Broken, Renewed) 78
- Live Ball Becomes Dead (Ball in Play – Dead Ball) 72
- Live-Ball – Dead-Ball Fouls (Penalties Completed) 144
- Live-Ball Fouls by the Same Team (Penalties Completed) 143
- Live Ball (The Ball: Live, Dead, Loose, Ready For Play) 29
- Loose Ball Out of Bounds (Out of Bounds) 76
- Loose Ball (The Ball: Live, Dead, Loose, Ready For Play) 29
- Loose Behind the Goal Line (Scrimmage Kicks) 89
- Loss of down (Down, Between Downs and Loss of Down) 32
- Mandatory and Illegal Equipment Enforcement (Players and Playing Equipment) 25
- Mandatory equipment (Players and Playing Equipment) 21
- Markers or Obstructions (The Field) 18
- Marking Balls (The Ball) 20
- Marking Boundary Areas (The Field) 15
- Minimum time for a play after spiking the ball (Playing Time and Intermissions) 54
- More than eleven players on the field (Substitutions) 69
- Muff (Fumble, Muff; Batting and Touching the Ball; Blocking a Kick) 34
- Next Play (Field Goal) 116
- Next Play (Try Down) 116
- Nine-Yard Marks (Lines) 35

- No Advance (Fair Catch) 94
- No Tackling (Fair Catch) 95
- Offensive and Defensive Teams (Team and Player Designations) 42
- Offensive pass interference fouls 194
- Offensive Team Requirements — At the Snap (The Scrimmage) 98
- Offensive Team Requirements — Prior to the Snap (The Scrimmage) 97
- Offsetting Fouls (Penalties Completed) 143
- Offside fouls 189, 199, 201
- Offside on a free kick play (Encroachment and Offside) 38
- Offside on a scrimmage play (Encroachment and Offside) 38
- Opportunity to Score (Try Down) 114
- Optional equipment (Players and Playing Equipment) 23
- Other rulings (Scope of instant replay) 154
- Out of Bounds at Forward Point (Out of Bounds) 77
- Out of Bounds (Backward Pass and Fumble) 102
- Out of Bounds Behind Goal Line (Scrimmage Kicks) 89
- Out of Bounds Between Goal Lines or at Rest Inbounds (Scrimmage Kicks) 89
- Out of Bounds Player (Scrimmage Kicks) 90
- Out-of-Bounds Spot (Spots) 41
- Passing (Passes) 38
- Pass interference fouls 193, 194
- Pass Interference: Summary (Forward Pass) 109
- Penalty Declined (Down and Possession After a Penalty) 80
- Penalty Resulting in New Series (Down and Possession After a Penalty) 80
- Personal Foul (Foul and Violation) 33
- Persons Subject to the Rules (General Provisions) 13
- Place Kick (Kicks; Kicking the Ball) 36
- Planned Loose Ball (The Scrimmage) 101
- Play-Clock Count (Ball in Play – Dead Ball) 76
- Play Clock (Timing Devices) 45
- Player Disqualification (Flagrant Fouls) 142
- Player Out of Bounds and In Bounds (Team and Player Designations) 44
- Player out of bounds fouls 201
- Player Out of Bounds (Free Kicks) 85
- Player Out of Bounds (Out of Bounds) 76
- Players' Numbering (Players and Playing Equipment) 21
- Player (Team and Player Designations) 43
- Player Vacancy (Team and Player Designations) 44
- Playing Enclosure (Field Areas) 46
- Playing Surface (Field Areas) 46
- Point of attack 189
- Possession (Catch, Recovery, Possession) 30
- Possession Series (Series and Possession Series) 41
- Postscrimmage Kick Enforcement (Enforcement Procedures) 147
- Postscrimmage Kick Spot (Spots) 42
- Pregame, First and Third Periods (Start of Each Period) 48
- Previous Spot (Spots) 41
- Prohibited Field Equipment (Players and Playing Equipment) 26
- Prohibited Signal Devices (Players and Playing Equipment) 26
- Punt (Kicks; Kicking the Ball) 36

- Pylons (The Field) 17
- Ready for play 209
- Receiving Team (Free Kick Out of Bounds) 86
- Recommended Numbering (Players and Playing Equipment) 20
- Referee communication (Players and Playing Equipment) 28
- Referee's Notification (Timeouts: Starting and Stopping the Clock) 63
- Removing persons from the playing enclosure (Unsportsmanlike Conduct Fouls) 137
- Replaced Player (Team and Player Designations) 44
- Requesting a review (Scope of instant replay) 152
- Responsibilities 151
- Responsibility (Responsibility and Impetus) 120
- Restraining Lines (Free Kicks) 82
- Restraining Lines (Lines) 35
- Result of the Play (Play Classification) 46
- Return Kick (Kicks; Kicking the Ball) 37
- Reviewable plays (Scope of instant replay) 152
- Roughing or Running into Kicker or Holder (Personal Fouls) 129
- Roughing/running into the kicker fouls 192, 213
- Roughing the passer fouls 192
- Roughing the Passer (Personal Fouls) 126
- Roughing the snapper fouls 195
- Rules Decisions Final (Down and Possession After a Penalty) 81
- Runner and Ball Carrier (Team and Player Designations) 43
- Running Play and Run (Play Classification) 46
- Scoring Plays (Value of Scores) 112
- Scrimmage Down (Scrimmage) 39
- Scrimmage Kick Formation (Kicks; Kicking the Ball) 37
- Scrimmage Kick (Kicks; Kicking the Ball) 37
- Scrimmage Kick Play (Play Classification) 45
- Scrimmage Line (Scrimmage) 40
- Second and Fourth Periods (Start of Each Period) 48
- Series (Series and Possession Series) 41
- Shift 40
- Shift and False Start (The Scrimmage) 96
- Sideline interference 205
- Sidelines (Lines) 35
- Side Zone (Field Areas) 47
- Simulating being roughed fouls 204
- Simulating other fouls 204
- Simultaneous Catch or Recovery (Catch, Recovery, Possession) 32
- Simultaneous with Snap (Penalties Completed) 143
- Snap After a Touchback (Touchback) 119
- Snapper (Team and Player Designations) 43
- Snapping the Ball 40
- Special Enforcement of Post-Possession Fouls (Enforcement Procedures) 150
- Specifications: Mandatory Equipment (Players and Playing Equipment) 21
- Specifications (The Ball) 19
- Spot of the Foul (Spots) 41
- Spot Where Kick Ends (Spots) 42
- Spot Where Run Ends (Spots) 41

- Squad Member (Team and Player Designations) 44
- Starting and Stopping the Clock (Timeouts: Starting and Stopping the Clock) 56
- Starting with a Snap (The Scrimmage) 96
- Striking Fouls and Tripping (Personal Fouls) 121
- Substitute (Team and Player Designations) 43
- Substitution Procedures (Substitutions) 67
- Succeeding Spot (Spots) 41
- Suspending the game (Timeouts: Starting and Stopping the Clock) 58
- Tackle Box 47
- Take a knee play 206
- Targeting 47
- Targeting and Making Forcible Contact to Head or Neck Area of a Defenseless Player (Personal Fouls) 122
- Targeting and Making Forcible Contact With the Crown of the Helmet (Personal Fouls) 122
- Targeting fouls 195
- Team Area and Coaching Box (The Field) 16
- Team B movement and signals fouls 199
- Team B personal foul and unsportsmanlike conduct during legal forward pass play (Forward Pass) 111
- Team Captains (General Provisions) 13
- Teams A and B (Team and Player Designations) 42
- The Field (Field Areas) 46
- The Game (General Provisions) 13
- The Neutral Zone 38
- Timeout (Timeouts: Starting and Stopping the Clock) 55
- Timing Adjustments (Playing Time and Intermissions) 51
- Timing Devices (Playing Time and Intermissions) 53
- Touchback 208
- Touching and Recovery of a Free Kick; Illegal Touching (Free Kicks) 84
- Touching (Fumble, Muff; Batting and Touching the Ball; Blocking a Kick) 34
- Touching Ground On or Behind Goal Line (Scrimmage Kicks) 89
- Two-minute Warning (Timeouts: Starting and Stopping the Clock) 60
- Unfair Acts (Unsportsmanlike Conduct Fouls) 135
- Unfair Clock Tactics (Delays/Clock Tactics) 65
- Unfair Tactics (Unsportsmanlike Conduct Fouls) 133
- Unnecessary roughness fouls 192, 195, 206
- Unsportsmanlike Acts (Unsportsmanlike Conduct Fouls) 130
- Unsportsmanlike conduct fouls 202, 213
- Valid Signal (Fair Catch) 33
- Violation (Foul and Violation) 34
- Violation Timeouts (Timeouts: Starting and Stopping the Clock) 62
- When Ball is Ready for Play (The Ball: Live, Dead, Loose, Ready For Play) 29
- When Declared (Touchback) 119
- When to Award Series (A Series: Started, Broken, Renewed) 78
- Who May Block (Blocking, Use of Hands or Arms) 137
- Winning Team and Final Score (General Provisions) 13
- Yard Lines (Lines) 35
- Youth players 188